

## EasyPACK™ module with CoolSiC™ Trench MOSFET and PressFIT / NTC

### Features

- Electrical features
  - $V_{DSS} = 1200\text{ V}$
  - $I_{DN} = 15\text{ A} / I_{DRM} = 30\text{ A}$
  - Low inductive design
  - Low switching losses
- Mechanical features
  - Rugged mounting due to integrated mounting clamps
  - PressFIT contact technology
  - Integrated NTC temperature sensor



### Potential applications

- High-frequency switching application
- DC/DC converter
- Motor drives
- UPS systems

### Product validation

- Qualified for industrial applications according to the relevant tests of IEC 60747, 60749 and 60068

### Description

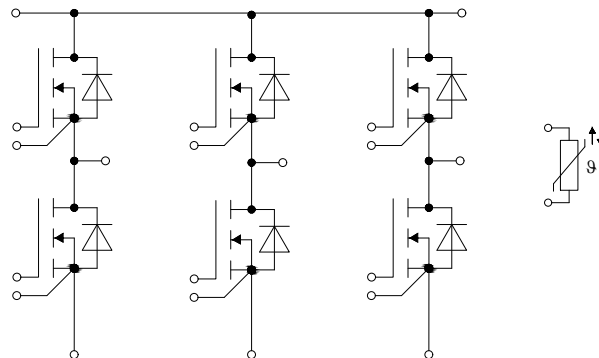

## Table of contents

	<b>Description</b> .....	1
	<b>Features</b> .....	1
	<b>Potential applications</b> .....	1
	<b>Product validation</b> .....	1
	<b>Table of contents</b> .....	2
<b>1</b>	<b>Package</b> .....	3
<b>2</b>	<b>MOSFET</b> .....	3
<b>3</b>	<b>Body diode</b> .....	5
<b>4</b>	<b>NTC-Thermistor</b> .....	6
<b>5</b>	<b>Characteristics diagrams</b> .....	7
<b>6</b>	<b>Circuit diagram</b> .....	12
<b>7</b>	<b>Package outlines</b> .....	13
<b>8</b>	<b>Module label code</b> .....	14
	<b>Revision history</b> .....	15
	<b>Disclaimer</b> .....	16

## 1 Package

**Table 1 Insulation coordination**

Parameter	Symbol	Note or test condition	Values	Unit
Isolation test voltage	$V_{ISOL}$	RMS, $f = 50 \text{ Hz}$ , $t = 1 \text{ min}$	3.0	kV
Internal isolation		basic insulation (class 1, IEC 61140)	$Al_2O_3$	
Creepage distance	$d_{Creep}$	terminal to heatsink	11.5	mm
Creepage distance	$d_{Creep}$	terminal to terminal	6.3	mm
Clearance	$d_{Clear}$	terminal to heatsink	10.0	mm
Clearance	$d_{Clear}$	terminal to terminal	5.0	mm
Comparative tracking index	$CTI$		> 200	
Relative thermal index (electrical)	$RTI$	housing	140	°C

**Table 2 Characteristic values**

Parameter	Symbol	Note or test condition	Values			Unit
			Min.	Typ.	Max.	
Stray inductance module	$L_{SCE}$			14		nH
Module lead resistance, terminals - chip	$R_{CC'+EE'}$	$T_H = 25^\circ\text{C}$ , per switch		3		mΩ
Storage temperature	$T_{stg}$		-40		125	°C
Mounting force per clamp	$F$		20		50	N
Weight	$G$			24		g

Note: The current under continuous operation is limited to 25 A rms per connector pin.

## 2 MOSFET

**Table 3 Maximum rated values**

Parameter	Symbol	Note or test condition	Values	Unit
Drain-source voltage	$V_{DSS}$	$T_{vj} = 25^\circ\text{C}$	1200	V
Implemented drain current	$I_{DN}$		15	A
Continuous DC drain current	$I_{DDC}$	$T_{vj} = 175^\circ\text{C}$ , $V_{GS} = 18 \text{ V}$ $T_H = 95^\circ\text{C}$	15	A
Repetitive peak drain current	$I_{DRM}$	verified by design, $t_p$ limited by $T_{vjmax}$	30	A
Gate-source voltage, max. transient voltage	$V_{GS}$	$D < 0.01$	-10/23	V

(table continues...)

**Table 3 (continued) Maximum rated values**

Parameter	Symbol	Note or test condition	Values	Unit
Gate-source voltage, max. static voltage	$V_{GS}$		-7/20	V

**Table 4 Recommended values**

Parameter	Symbol	Note or test condition	Values	Unit
On-state gate voltage	$V_{GS(on)}$		15...18	V
Off-state gate voltage	$V_{GS(off)}$		-5...0	V

**Table 5 Characteristic values**

Parameter	Symbol	Note or test condition	Values			Unit	
			Min.	Typ.	Max.		
Drain-source on-resistance	$R_{DS(on)}$	$I_D = 15\text{ A}$	$V_{GS} = 18\text{ V}$ , $T_{vj} = 25\text{ °C}$		52.9	79	mΩ
			$V_{GS} = 18\text{ V}$ , $T_{vj} = 125\text{ °C}$		85.5		
			$V_{GS} = 18\text{ V}$ , $T_{vj} = 175\text{ °C}$		114		
			$V_{GS} = 15\text{ V}$ , $T_{vj} = 25\text{ °C}$		63.5		
Gate threshold voltage	$V_{GS(th)}$	$I_D = 6\text{ mA}$ , $V_{DS} = V_{GS}$ , $T_{vj} = 25\text{ °C}$ , (tested after 1ms pulse at $V_{GS} = +20\text{ V}$ )	3.45	4.3	5.15	V	
Total gate charge	$Q_G$	$V_{DS} = 800\text{ V}$ , $V_{GS} = -3/18\text{ V}$		0.045		μC	
Internal gate resistor	$R_{Gint}$	$T_{vj} = 25\text{ °C}$		7.5		Ω	
Input capacitance	$C_{ISS}$	$f = 100\text{ kHz}$ , $V_{DS} = 800\text{ V}$ , $V_{GS} = 0\text{ V}$		1.35		nF	
Output capacitance	$C_{OSS}$	$f = 100\text{ kHz}$ , $V_{DS} = 800\text{ V}$ , $V_{GS} = 0\text{ V}$		0.064		nF	
Reverse transfer capacitance	$C_{rSS}$	$f = 100\text{ kHz}$ , $V_{DS} = 800\text{ V}$ , $V_{GS} = 0\text{ V}$		0.004		nF	
$C_{OSS}$ stored energy	$E_{OSS}$	$V_{DS} = 800\text{ V}$ , $V_{GS} = -3/18\text{ V}$ , $T_{vj} = 25\text{ °C}$		26.2		μJ	
Drain-source leakage current	$I_{DSS}$	$V_{DS} = 1200\text{ V}$ , $V_{GS} = -3\text{ V}$		0.01	110	μA	
Gate-source leakage current	$I_{GSS}$	$V_{DS} = 0\text{ V}$ , $T_{vj} = 25\text{ °C}$			400	nA	
Turn-on delay time (inductive load)	$t_{d\ on}$	$I_D = 15\text{ A}$ , $R_{Gon} = 3.9\text{ Ω}$ , $V_{DS} = 600\text{ V}$ , $V_{GS} = -3/18\text{ V}$	$T_{vj} = 25\text{ °C}$		23.1	ns	
			$T_{vj} = 125\text{ °C}$		23.1		
			$T_{vj} = 175\text{ °C}$		23.1		

**(table continues...)**

**Table 5 (continued) Characteristic values**

Parameter	Symbol	Note or test condition	Values			Unit
			Min.	Typ.	Max.	
Rise time (inductive load)	$t_r$	$I_D = 15\text{ A}, R_{Gon} = 3.9\ \Omega,$ $V_{DS} = 600\text{ V}, V_{GS} = -3/18\text{ V}$	$T_{vj} = 25\text{ °C}$	19.7		ns
			$T_{vj} = 125\text{ °C}$	20.5		
			$T_{vj} = 175\text{ °C}$	21.1		
Turn-off delay time (inductive load)	$t_{d\ off}$	$I_D = 15\text{ A}, R_{Goff} = 3.3\ \Omega,$ $V_{DS} = 600\text{ V}, V_{GS} = -3/18\text{ V}$	$T_{vj} = 25\text{ °C}$	43.7		ns
			$T_{vj} = 125\text{ °C}$	48.4		
			$T_{vj} = 175\text{ °C}$	51.1		
Fall time (inductive load)	$t_f$	$I_D = 15\text{ A}, R_{Goff} = 3.3\ \Omega,$ $V_{DS} = 600\text{ V}, V_{GS} = -3/18\text{ V}$	$T_{vj} = 25\text{ °C}$	17.3		ns
			$T_{vj} = 125\text{ °C}$	17.3		
			$T_{vj} = 175\text{ °C}$	17.3		
Turn-on energy loss per pulse	$E_{on}$	$I_D = 15\text{ A}, V_{DS} = 600\text{ V},$ $L_\sigma = 6\text{ nH}, V_{GS} = -3/18\text{ V},$ $R_{Gon} = 3.9\ \Omega, di/dt = 1.8$ $\text{kA}/\mu\text{s} (T_{vj} = 175\text{ °C})$	$T_{vj} = 25\text{ °C}$	0.235		mJ
			$T_{vj} = 125\text{ °C}$	0.297		
			$T_{vj} = 175\text{ °C}$	0.334		
Turn-off energy loss per pulse	$E_{off}$	$I_D = 15\text{ A}, V_{DS} = 600\text{ V},$ $L_\sigma = 6\text{ nH}, V_{GS} = -3/18\text{ V},$ $R_{Goff} = 3.3\ \Omega, dv/dt = 27.7$ $\text{kV}/\mu\text{s} (T_{vj} = 175\text{ °C})$	$T_{vj} = 25\text{ °C}$	0.037		mJ
			$T_{vj} = 125\text{ °C}$	0.041		
			$T_{vj} = 175\text{ °C}$	0.043		
Thermal resistance, junction to heat sink	$R_{thJH}$	per MOSFET		2.03		K/W
Temperature under switching conditions	$T_{vj\ op}$		-40		175	°C

*Note: The selection of positive and negative gate-source voltages impacts losses and the long-term behavior of the MOSFET and body diode. The design guidelines described in Application Notes AN 2018-09 and AN 2021-13 must be considered to ensure sound operation of the device over the planned lifetime.*

*$T_{vj,op} > 150\text{ °C}$  is allowed for operation at overload conditions for MOSFET and body diode. For detailed specifications, please refer to AN 2021-13.*

### 3 Body diode

**Table 6 Maximum rated values**

Parameter	Symbol	Note or test condition	Values	Unit
DC body diode forward current	$I_{SD}$	$T_{vj} = 175\text{ °C}, V_{GS} = -3\text{ V}$ $T_H = 105\text{ °C}$	7	A

**Table 7** Characteristic values

Parameter	Symbol	Note or test condition	Values			Unit	
			Min.	Typ.	Max.		
Forward voltage	$V_{SD}$	$I_{SD} = 15 \text{ A}, V_{GS} = -3 \text{ V}$	$T_{vj} = 25 \text{ °C}$		4.2	5.35	V
			$T_{vj} = 125 \text{ °C}$		3.9		
			$T_{vj} = 175 \text{ °C}$		3.8		

## 4 NTC-Thermistor

**Table 8** Characteristic values

Parameter	Symbol	Note or test condition	Values			Unit
			Min.	Typ.	Max.	
Rated resistance	$R_{25}$	$T_{NTC} = 25 \text{ °C}$		5		kΩ
Deviation of $R_{100}$	$\Delta R/R$	$T_{NTC} = 100 \text{ °C}, R_{100} = 493 \text{ } \Omega$	-5		5	%
Power dissipation	$P_{25}$	$T_{NTC} = 25 \text{ °C}$			20	mW
B-value	$B_{25/50}$	$R_2 = R_{25} \exp[B_{25/50}(1/T_2 - 1/(298,15 \text{ K}))]$		3375		K
B-value	$B_{25/80}$	$R_2 = R_{25} \exp[B_{25/80}(1/T_2 - 1/(298,15 \text{ K}))]$		3411		K
B-value	$B_{25/100}$	$R_2 = R_{25} \exp[B_{25/100}(1/T_2 - 1/(298,15 \text{ K}))]$		3433		K

Note: Specification according to the valid application note.

## 5 Characteristics diagrams

**Output characteristic (typical), MOSFET**

$I_D = f(V_{DS})$   
 $V_{GS} = 18\text{ V}$

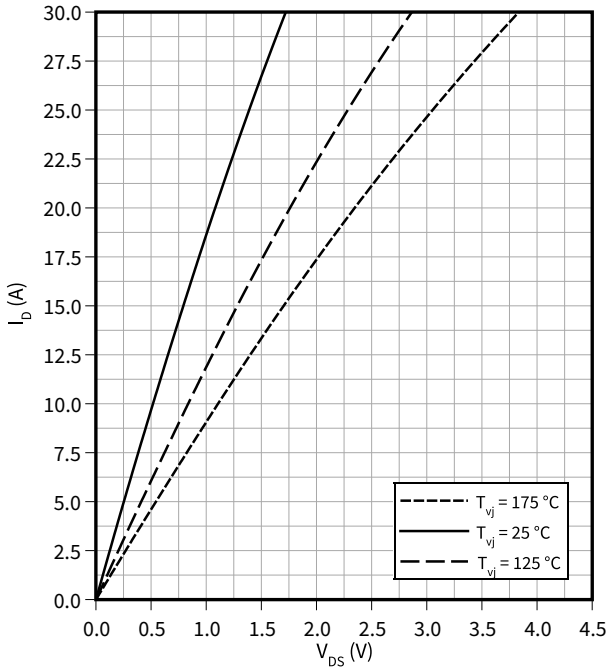

**Output characteristic (typical), MOSFET**

$I_D = f(V_{DS})$   
 $V_{GS} = 15\text{ V}$

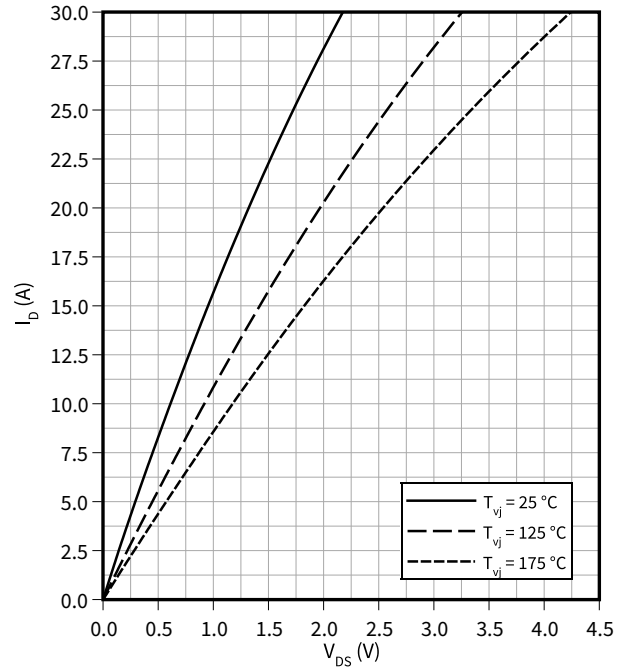

**Drain source on-resistance (typical), MOSFET**

$R_{DS(on)} = f(I_D)$   
 $V_{GS} = 18\text{ V}$

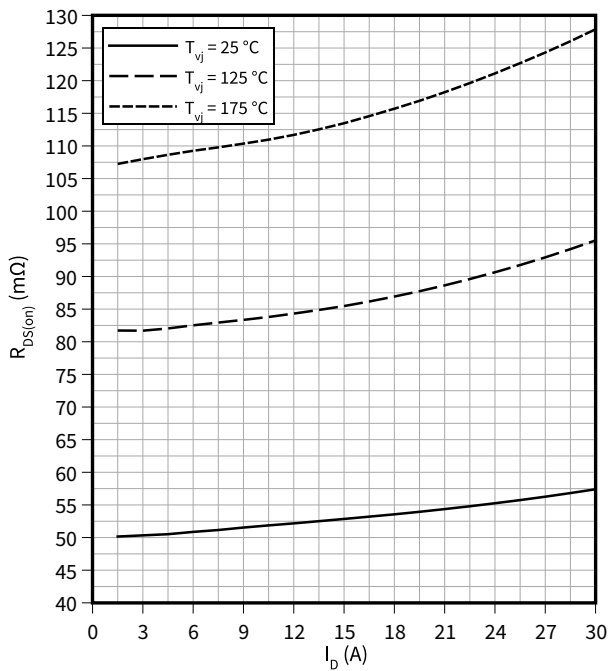

**Drain source on-resistance (typical), MOSFET**

$R_{DS(on)} = f(T_{vj})$   
 $I_D = 15\text{ A}$

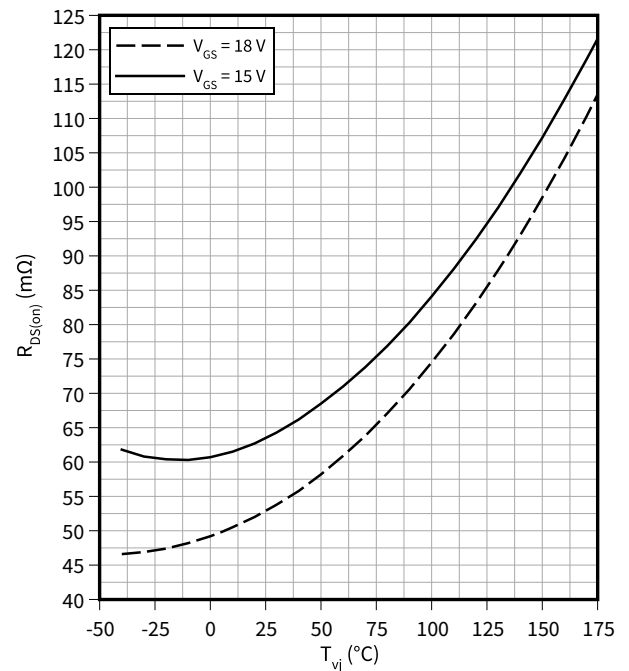

5 Characteristics diagrams

**Output characteristic field (typical), MOSFET**

$I_D = f(V_{DS})$   
 $T_{vj} = 175\text{ °C}$

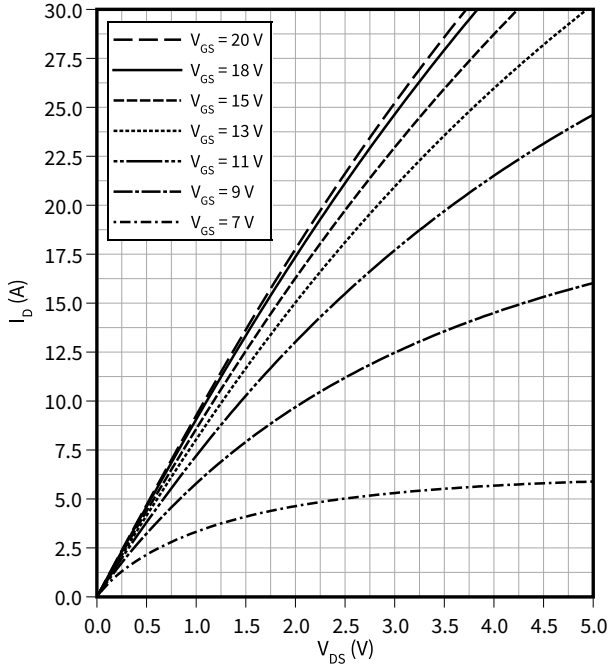

**Transfer characteristic (typical), MOSFET**

$I_D = f(V_{GS})$   
 $V_{DS} = 20\text{ V}$

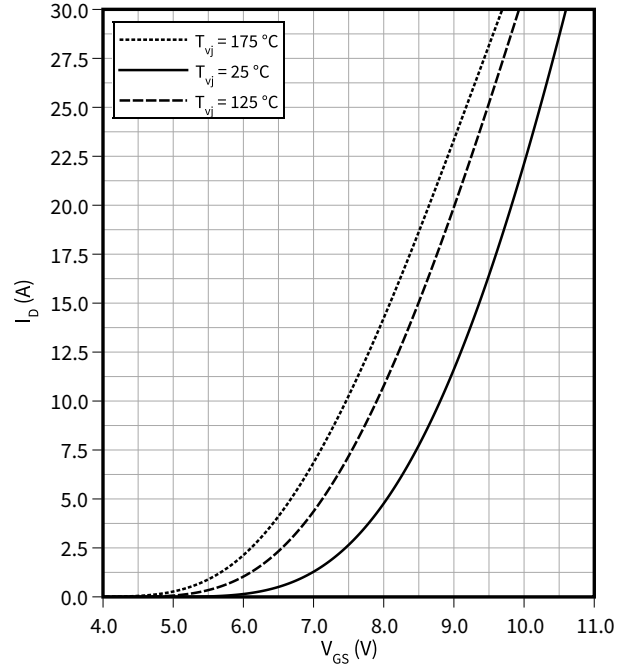

**Gate-source threshold voltage (typical), MOSFET**

$V_{GS(th)} = f(T_{vj})$   
 $V_{GS} = V_{DS}$

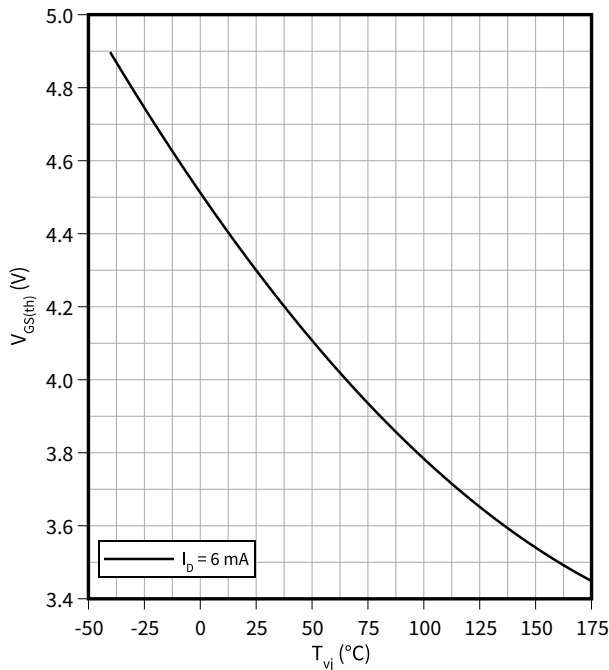

**Gate charge characteristic (typical), MOSFET**

$V_{GS} = f(Q_G)$   
 $I_D = 15\text{ A}, T_{vj} = 25\text{ °C}$

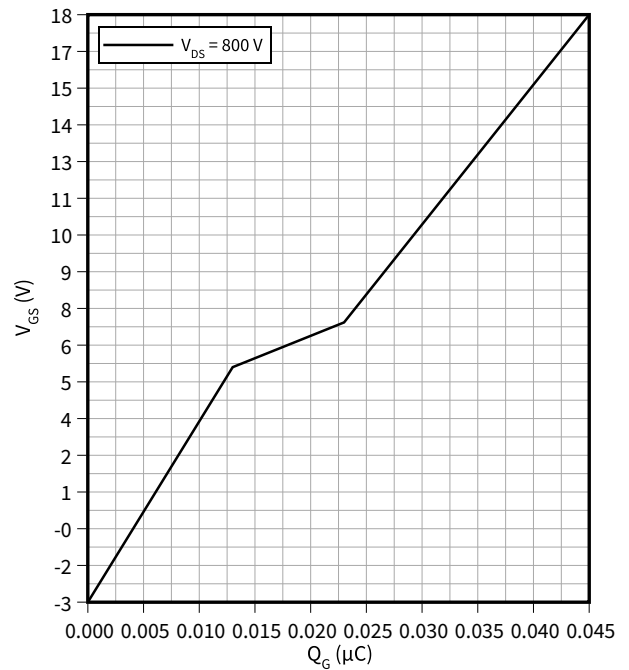



5 Characteristics diagrams

**Capacity characteristic (typical), MOSFET**

$C = f(V_{DS})$   
 $f = 100 \text{ kHz}, T_{vj} = 25 \text{ }^\circ\text{C}, V_{GS} = 0 \text{ V}$

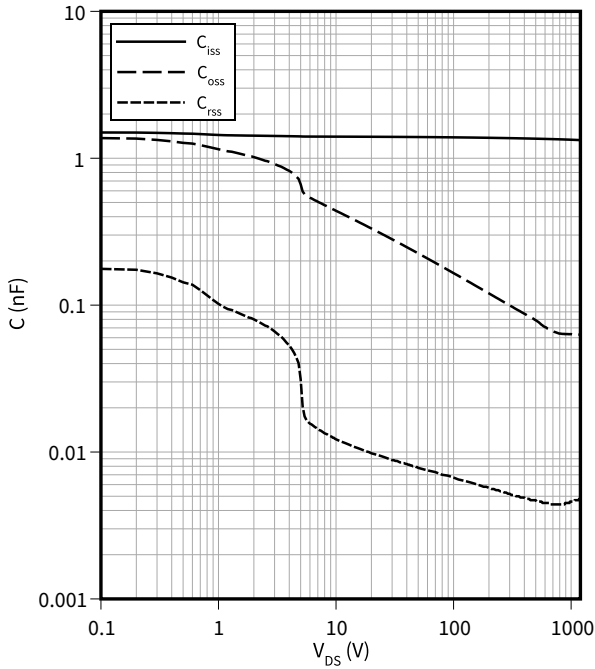

**Forward characteristic body diode (typical), MOSFET**

$I_{SD} = f(V_{SD})$   
 $T_{vj} = 25 \text{ }^\circ\text{C}$

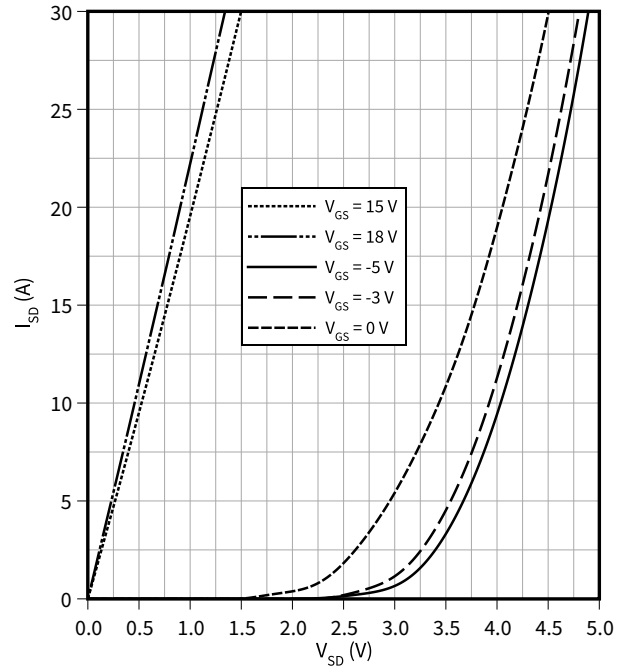

**Forward voltage of body diode (typical), MOSFET**

$V_{SD} = f(T_{vj})$   
 $I_{SD} = 15 \text{ A}$

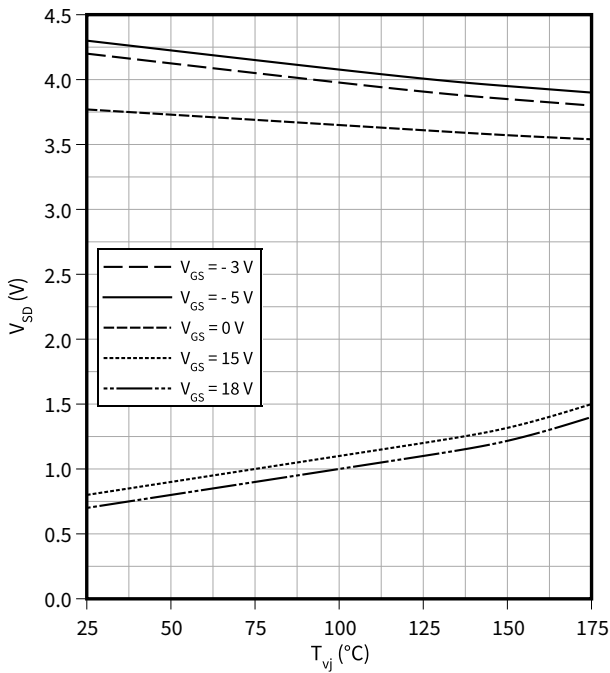

**Switching losses (typical), MOSFET**

$E = f(I_D)$   
 $R_{Goff} = 3.3 \text{ } \Omega, R_{Gon} = 3.9 \text{ } \Omega, V_{DS} = 600 \text{ V}, V_{GS} = -3/18 \text{ V}$

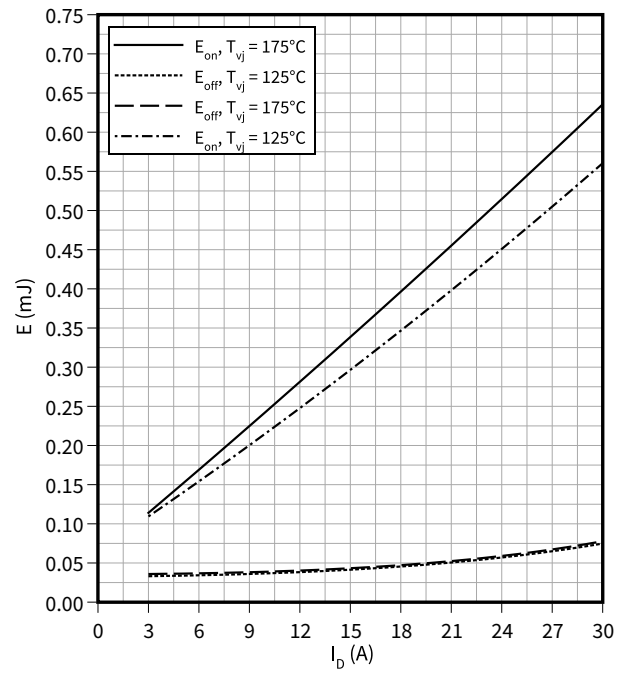

**Switching losses (typical), MOSFET**

$E = f(R_G)$

$V_{DS} = 600\text{ V}$ ,  $I_D = 15\text{ A}$ ,  $V_{GS} = -3/18\text{ V}$

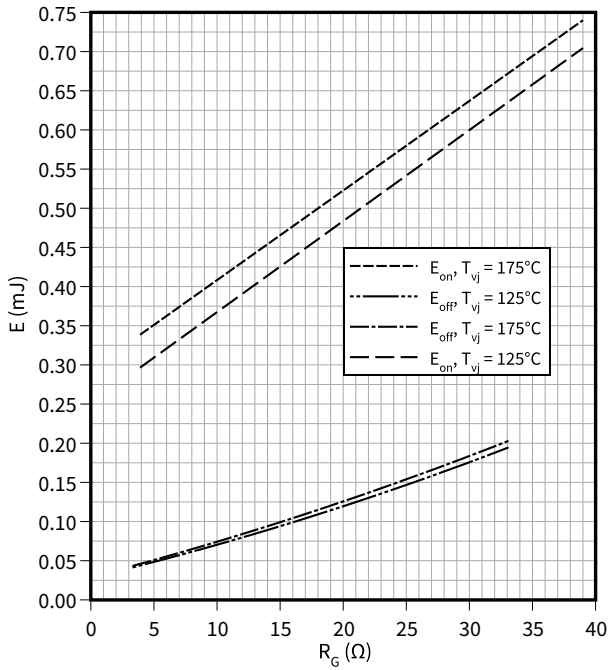

**Switching times (typical), MOSFET**

$t = f(I_D)$

$R_{Goff} = 3.3\ \Omega$ ,  $R_{Gon} = 3.9\ \Omega$ ,  $V_{DS} = 600\text{ V}$ ,  $T_{vj} = 175\text{ °C}$ ,  $V_{GS} = -3/18\text{ V}$

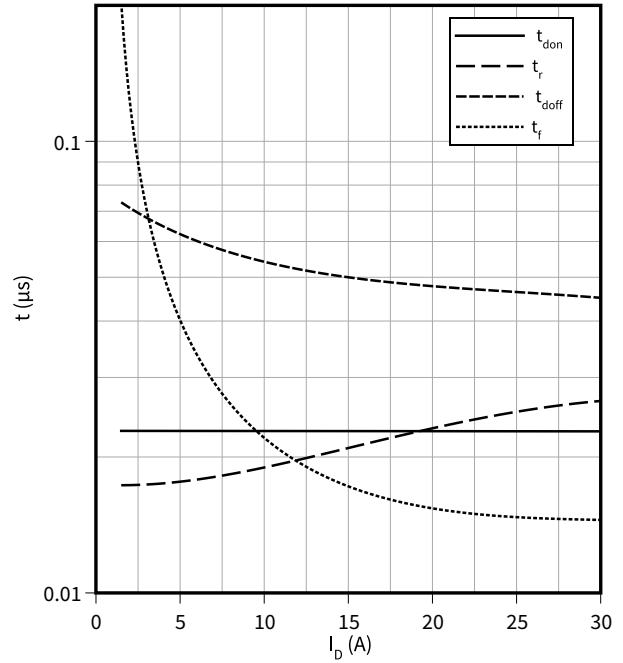

**Switching times (typical), MOSFET**

$t = f(R_G)$

$V_{DS} = 600\text{ V}$ ,  $I_D = 15\text{ A}$ ,  $T_{vj} = 175\text{ °C}$ ,  $V_{GS} = -3/18\text{ V}$

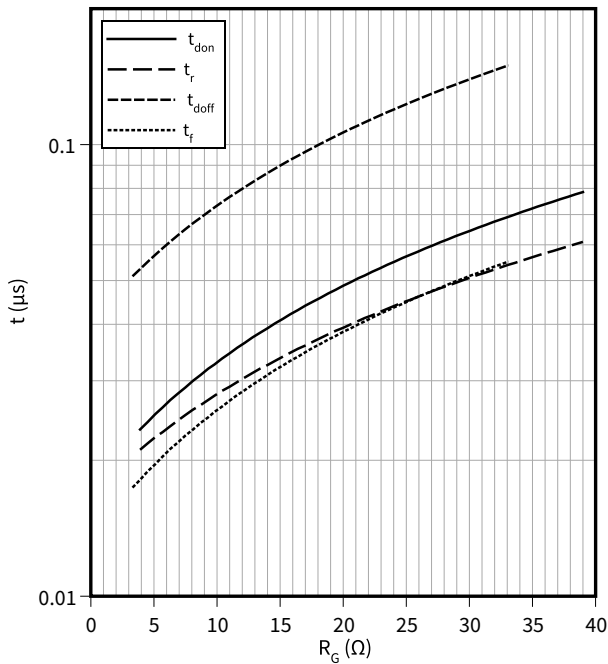

**Current slope (typical), MOSFET**

$di/dt = f(R_G)$

$V_{DS} = 600\text{ V}$ ,  $I_D = 15\text{ A}$ ,  $V_{GS} = -3/18\text{ V}$

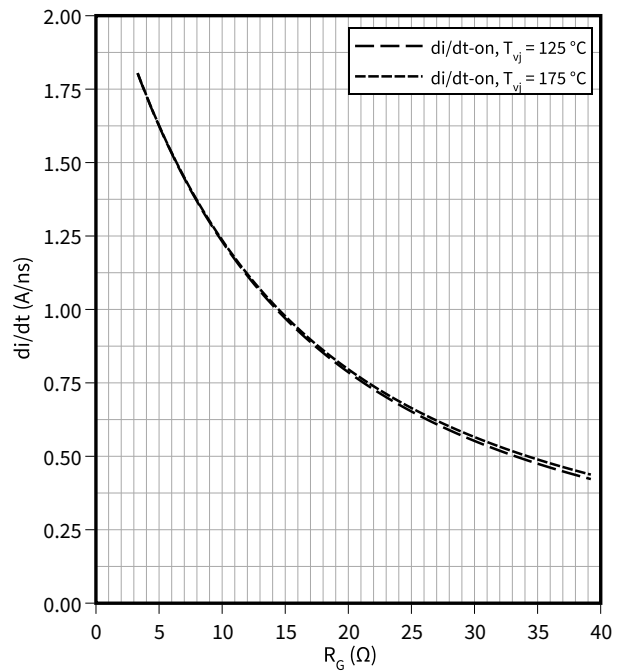

5 Characteristics diagrams

**Voltage slope (typical), MOSFET**

$dv/dt = f(R_G)$

$V_{DS} = 600\text{ V}$ ,  $I_D = 15\text{ A}$ ,  $V_{GS} = -3/18\text{ V}$

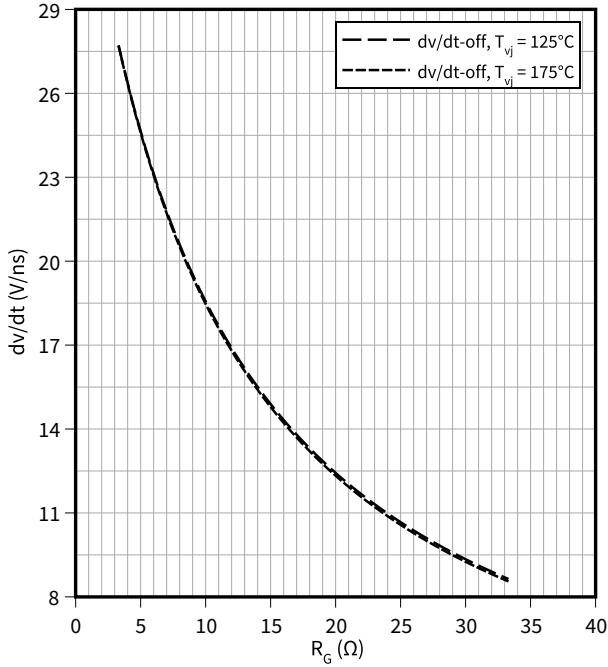

**Reverse bias safe operating area (RBSOA), MOSFET**

$I_D = f(V_{DS})$

$R_{Goff} = 3.3\ \Omega$ ,  $T_{vj} = 175\text{ °C}$ ,  $V_{GS} = -3/18\text{ V}$

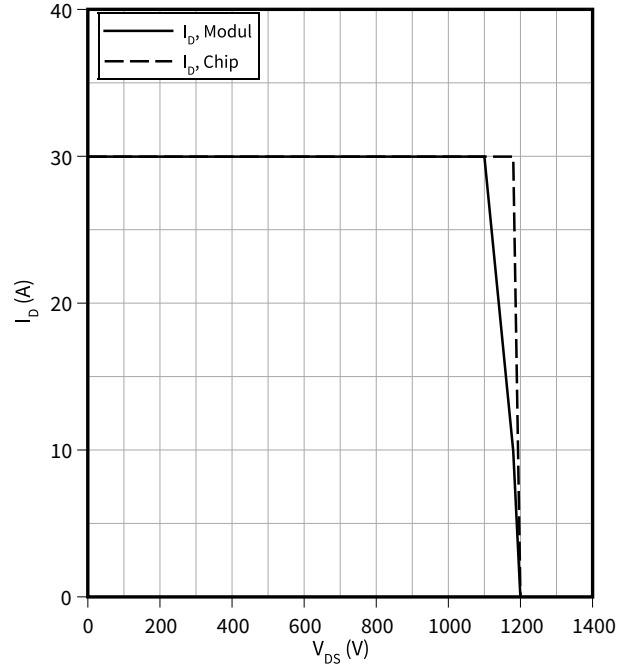

**Transient thermal impedance, MOSFET**

$Z_{th} = f(t)$

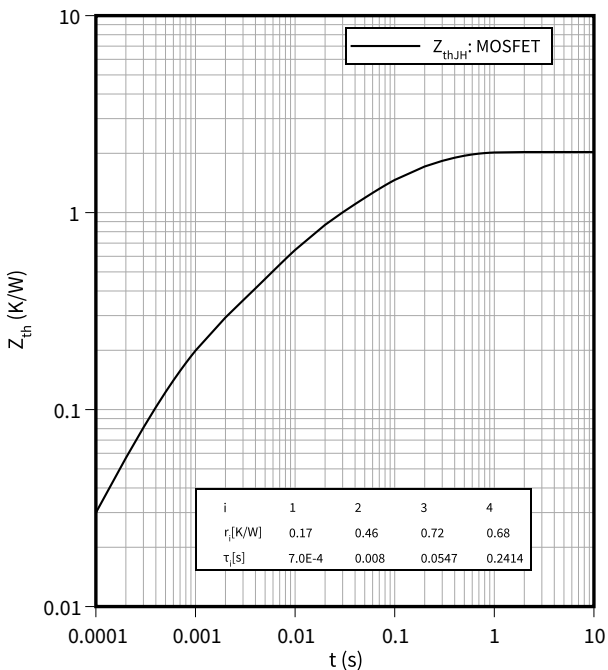

**Temperature characteristic (typical), NTC-Thermistor**

$R = f(T_{NTC})$

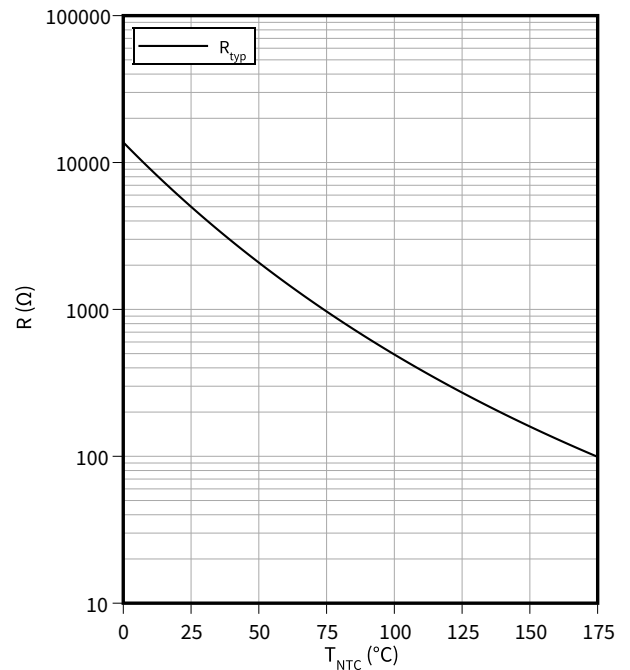

## 6 Circuit diagram

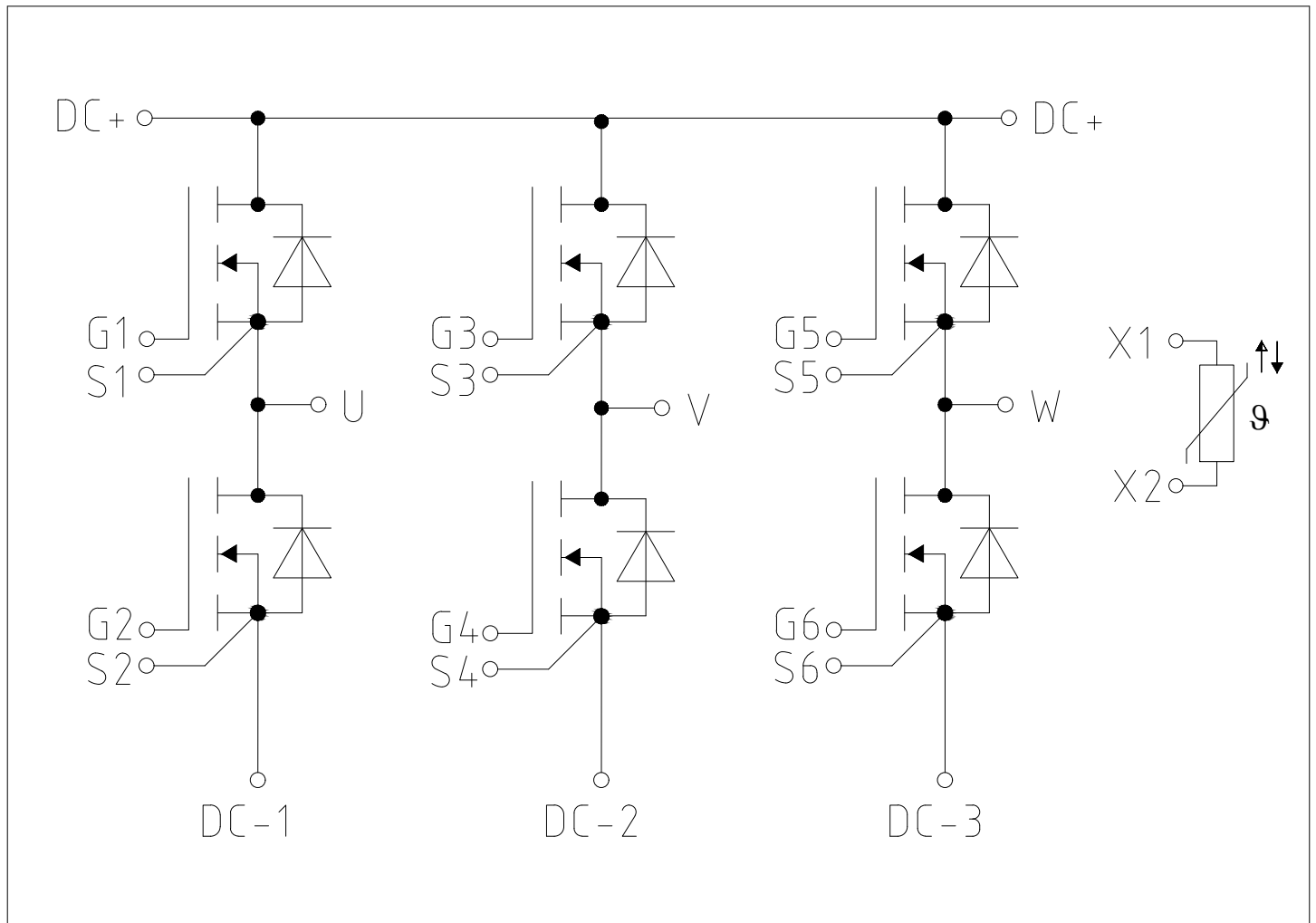

Figure 1

## 7 Package outlines

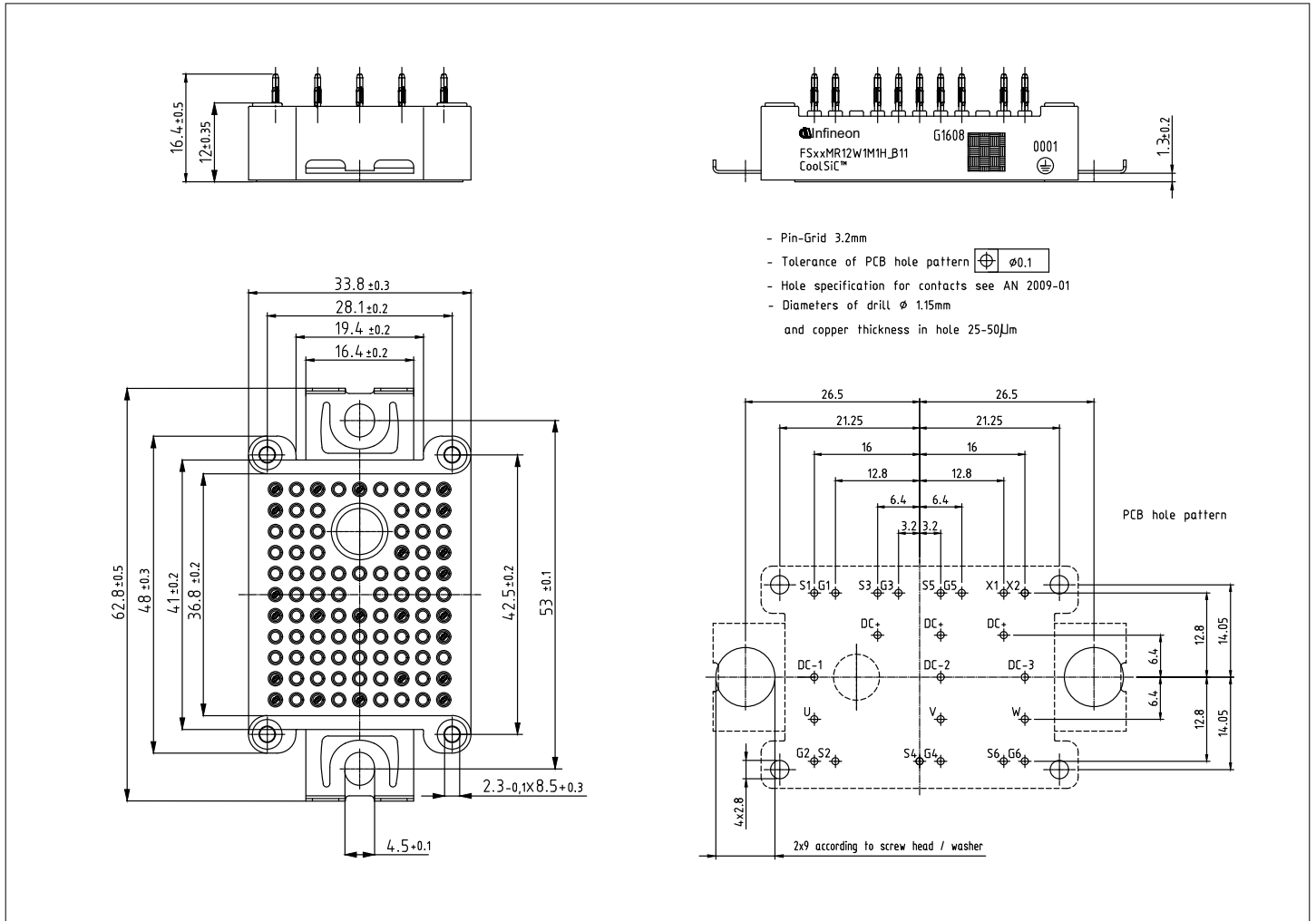

Figure 2

## 8 Module label code

Module label code			
Code format	Data Matrix	Barcode Code128	
Encoding	ASCII text	Code Set A	
Symbol size	16x16	23 digits	
Standard	IEC24720 and IEC16022	IEC8859-1	
Code content	<i>Content</i> Module serial number Module material number Production order number Date code (production year) Date code (production week)	<i>Digit</i> 1 - 5 6 - 11 12 - 19 20 - 21 22 - 23	<i>Example</i> 71549 142846 55054991 15 30
Example	<div style="display: flex; justify-content: space-around; align-items: center;"> <div style="text-align: center;">               71549142846550549911530         </div> <div style="text-align: center;">               71549142846550549911530         </div> </div>		

**Figure 3**

## Revision history

Document revision	Date of release	Description of changes
0.10	2021-05-10	Target datasheet
1.00	2022-03-03	Final datasheet
1.10	2022-04-13	Add of missing dv/dt and di/dt in table for dynamic parameters

## Trademarks

All referenced product or service names and trademarks are the property of their respective owners.

**Edition 2022-04-13**

**Published by**

**Infineon Technologies AG**

**81726 Munich, Germany**

**© 2022 Infineon Technologies AG**

**All Rights Reserved.**

**Do you have a question about any aspect of this document?**

**Email: [erratum@infineon.com](mailto:erratum@infineon.com)**

**Document reference**

**IFX-AAV072-003**

## IMPORTANT NOTICE

The information given in this document shall in no event be regarded as a guarantee of conditions or characteristics ("Beschaffenhheitsgarantie").

With respect to any examples, hints or any typical values stated herein and/or any information regarding the application of the product, Infineon Technologies hereby disclaims any and all warranties and liabilities of any kind, including without limitation warranties of non-infringement of intellectual property rights of any third party.

In addition, any information given in this document is subject to customer's compliance with its obligations stated in this document and any applicable legal requirements, norms and standards concerning customer's products and any use of the product of Infineon Technologies in customer's applications.

The data contained in this document is exclusively intended for technically trained staff. It is the responsibility of customer's technical departments to evaluate the suitability of the product for the intended application and the completeness of the product information given in this document with respect to such application.

## WARNINGS

Due to technical requirements products may contain dangerous substances. For information on the types in question please contact your nearest Infineon Technologies office.

Except as otherwise explicitly approved by Infineon Technologies in a written document signed by authorized representatives of Infineon Technologies, Infineon Technologies' products may not be used in any applications where a failure of the product or any consequences of the use thereof can reasonably be expected to result in personal injury.