

Pulse Rate-Torque Characteristics/Pulse Rate-Power Current Characteristics

PMM-UA-4304-1

● 103H8222-09 □□ : 100V

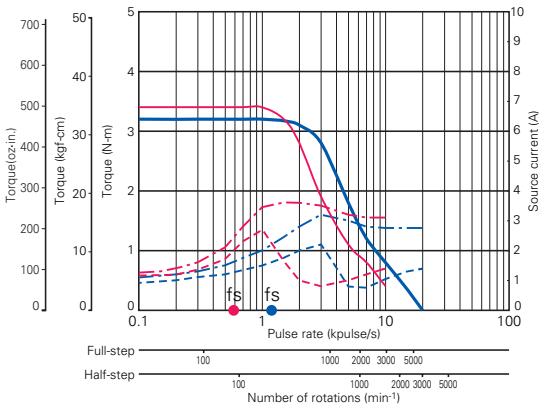

Source voltage : AC100V, Operating current : 4A/phase
 — Pull-Out torque [JL1=15.3x10⁻⁴kg-m² (83.65 oz-in²) Use the rubber coupling]
 - - - Source current (TL=MAX), - - - Source current (TL=0)

● 103H8223-09 □□ : 100V

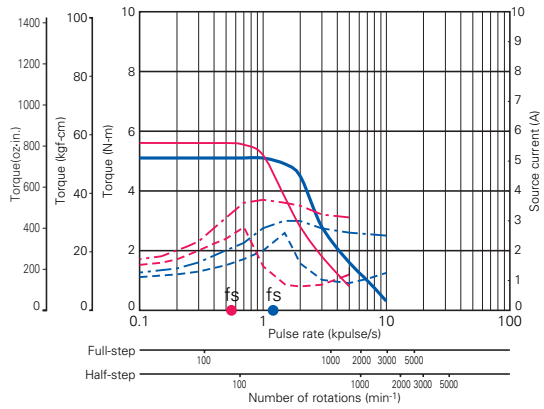

Source voltage : AC100V, Operating current : 4A/phase
 — Pull-Out torque [JL1=15.3x10⁻⁴kg-m² (83.65 oz-in²) Use the rubber coupling]
 - - - Source current (TL=MAX), - - - Source current (TL=0)

● 103H89222-09 □□ : 100V

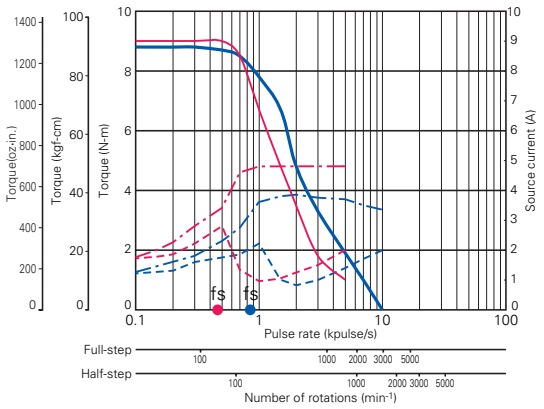

Source voltage : AC100V, Operating current : 4A/phase
 — Pull-Out torque [JL1=43x10⁻⁴kg-m² (235.10 oz-in²) Use the rubber coupling]
 - - - Source current (TL=MAX), - - - Source current (TL=0)

● 103H89223-09 □□ : 100V

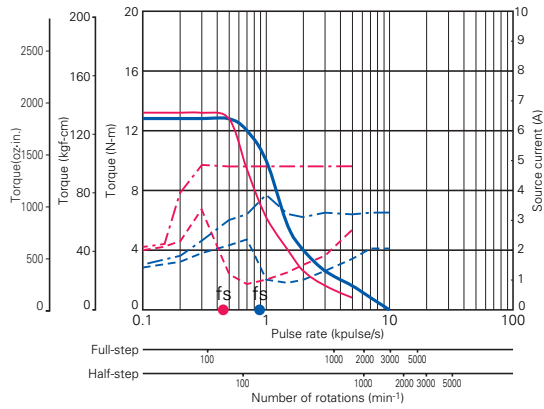

Source voltage : AC100V, Operating current : 4A/phase
 — Pull-Out torque [JL1=43x10⁻⁴kg-m² (235.10 oz-in²) Use the rubber coupling]
 - - - Source current (TL=MAX), - - - Source current (TL=0)

Options

● Terminal board cover

PMM-UA-4303-1

Model No.	PM-AP-018
-----------	-----------

PMM-UA-4304-1

Model No.	PM-AP-019
-----------	-----------

PMM-BA-4803
PMM-BA-4804

PMM-UA-4303
PMM-UA-4304

PMM-UD-2310-10/2321-10
PMM-UD-2320-21/2321-21
PMM-UD-2320-10/2321-10

PMM-UD-2312D

2-phase Stepping Driver



DC24V/36V Unipolar type

(Applicable motor rated current 1.2A/phase, 2A/phase)

Micro-step (200 X 1~8 divisions)

(Smooth operation and low vibration even at low speeds.)

PMM-MD-23210-10 (Photo coupler input method)

PMM-MD-23211-10 (CMOS input method)

PMM-MD-23220-21 (Photo coupler input method)

PMM-MD-23221-21 (CMOS input method)

PMM-MD-23220-10 (Photo coupler input method)

PMM-MD-23221-10 (CMOS input method)

● Applicable motor



● Applicable motor



● Applicable motor



Standard combined stepping motors

PMM-MD-23210-10, PMM-MD-23211-10

Dimensions of stepping motor	Stepping motor model number		Rated current [A/phase]	Holding torque [N·m(oz·in)]	Rotor inertia [$\times 10^{-4}$ kg·m ² (oz·in ²)]	Mass(Weight) [kg(lbs)]	Page
	Single shaft	Double shaft					
□28mm(1.10inch)	103H3215-5240	103H3215-5210	1	0.062(8.78)	0.016(0.09)	0.22(0.49)	65 Page

PMM-MD-23220-21, PMM-MD-23221-21

Dimensions of stepping motor	Stepping motor model number		Rated current [A/phase]	Holding torque [N·m(oz·in)]	Rotor inertia [$\times 10^{-4}$ kg·m ² (oz·in ²)]	Mass(Weight) [kg(lbs)]	Page
	Single shaft	Double shaft					
□35mm	SH3533-12U40	SH3533-12U10	1.2	0.12(16.99)	0.02(1.09)	0.17(0.37)	61 Page
	SH3537-12U40	SH3537-12U10	1.2	0.15(21.24)	0.025(1.37)	0.2(0.44)	
	SH3552-12U40	SH3552-12U10	1.2	0.24(33.99)	0.043(2.35)	0.3(0.66)	
□42mm (1.65inch)	103H5205-0440	103H5205-0410	1.2	0.2(28.32)	0.036(0.20)	0.23(0.51)	64 Page
	103H5208-0440	103H5208-0410	1.2	0.3(42.48)	0.056(0.31)	0.29(0.64)	
	103H5209-0440	103H5209-0410	1.2	0.32(45.31)	0.062(0.34)	0.31(0.68)	
	103H5210-0440	103H5210-0410	1.2	0.37(52.39)	0.074(0.40)	0.37(0.82)	

PMM-MD-23220-10, PMM-MD-23221-10

Dimensions of stepping motor	Stepping motor model number		Rated current [A/phase]	Holding torque [N·m(oz·in)]	Rotor inertia [$\times 10^{-4}$ kg·m ² (oz·in ²)]	Mass(Weight) [kg(lbs)]	Page
	Single shaft	Double shaft					
□50mm (1.97inch)	103H6701-0440	103H6701-0410	2	0.28(39.6)	0.057(0.31)	0.35(0.77)	75 Page
	103H6703-0440	103H6703-0410	2	0.49(69.4)	0.118(0.65)	0.5(1.10)	
	103H6704-0440	103H6704-0410	2	0.52(73.6)	0.14(0.77)	0.5(1.10)	
□56mm (2.20inch)	103H7121-0440	103H7121-0410	2	0.39(55.2)	0.1(0.55)	0.47(1.04)	79 Page
	103H7123-0440	103H7123-0410	2	0.83(117.5)	0.21(1.15)	0.65(1.43)	
	103H7124-0440	103H7124-0410	2	0.98(138.8)	0.245(1.34)	0.8(1.76)	
	103H7126-0440	103H7126-0410	2	1.27(179.8)	0.36(1.97)	0.98(2.16)	
□60mm (2.36inch)	103H7821-0440	103H7821-0410	2	0.78(110.5)	0.275(1.50)	0.6(1.32)	87 Page
	103H7822-0440	103H7822-0410	2	1.17(165.7)	0.4(2.19)	0.77(1.70)	
	103H7823-0440	103H7823-0410	2	2.1(297.4)	0.84(4.59)	1.34(2.95)	
ø86mm (3.39inch)	103H8221-0441	103H8221-0411	2	2.15(304.5)	1.45(7.93)	1.5(3.31)	91 Page
	103H8222-0441	103H8222-0411	2	4.13(584.8)	2.9(15.86)	2.5(5.51)	
	103H8223-0441	103H8223-0411	2	6.27(887.9)	4.4(24.06)	3.5(7.72)	

• For information about the general specifications and dimensions of each stepping motor, refer to its page.

Specifications of PM Driver

Item		Photo coupler input method			CMOS input method			
		PMM-MD-23210-10	PMM-MD-23220-21	PMM-MD-23220-10	PMM-MD-23211-10	PMM-MD-23221-21	PMM-MD-23221-10	
Basic specifications	Input source	Main power	DC24V/36V±10%					
		Control power	—			DC5V±5%		
	Getaway torque	Main power	2A	2A	3A	2A	2A	3A
		Control power	—					
	Rated current	1A/phase	1.2A/phase	2A/phase	1A/phase	1.2A/phase	2A/phase	
	Operating ambient temperature	0~+50°C						
	Conservation temperature	-20~+70°C						
	Operating ambient humidity	35~85% RH (no condensation)						
	Conservation humidity	10~90% RH (no condensation)						
	Vibration resistance	4.9m/s ² Frequency range 10~55Hz, Direction: along X,Y and Z axes, for 2 hours each.						
Impact resistance	Considering the NDS-C-0110 standard section 3.2.2 division "C", not influenced.							
Withstand voltage	Not influenced when AC500V is applied between power input terminal and cabinet for one minute.							
Insulation resistance	10MΩ MIN. when measured with DC500V megohmmeter between input terminal and cabinet.							
Mass(Weight)	0.18kg(0.4lbs)							
Function	Selection, setting function Pulse input mode selection— DIP switches enables selection of Pulse and direction and 2-input mode. Resolution setting— DIP switches enables 4 divisions ranging from 1~8 resolution. Power down — External signal input enables to turn off the current that flows through the stepping motor. Automatic current down selection— Automatic current down function can be selected. Resolution selection— External signal input enables to select 1 division (Full-step) and 2 divisions (Half-step) (Resolution selection function is only for photo coupler input method type)							
I/O signals	Signal Name (Brevity code)	Pin No. (CN1)						
		Photo coupler input method	CMOS input method					
	CW pulse Input signal (CW)	1	7	In the 2-input mode, inputs driving pulses to rotate in CW direction. In the Pulse and direction mode, inputs driving pulse train to rotate the step motor rotation. Photo coupler input method, input resistance 330Ω CMOS input method Input signal voltage: H = 4.0 to 5.5V, L = 0 to 0.5V Input signal voltage: H = 4.0 to 5.5V, L = 0 to 0.5V Maximum input frequency:20kpulse/s Maximum input frequency:20kpulse/s.				
		2						
	(CK)							
	CCW pulse Input signal (CCW)	3	8	In the 2-input mode, inputs driving pulses to rotate in CCW direction. In the Pulse and direction mode, inputs rotation direction signals to the stepping motor. Internal photo coupler ON (CMOS type: "H" level): — CW direction Internal photo coupler OFF (CMOS type: "L" level)— CCW direction. Photo coupler input method, input resistance 330Ω CMOS input method Input signal voltage: H = 4.0 to 5.5V, L = 0 to 0.5V Input signal voltage: H = 4.0 to 5.5V, L = 0 to 0.5V Maximum input frequency:20kpulse/s Maximum input frequency:20kpulse/s.				
		4						
	(U/D)							
Power down input signal (PD)	5	9	Inputs PD signal to turn off the current that flows through the stepping motor. Internal photo coupler ON (CMOS type: "L" level input) — Power down function is enabled. Photo coupler input method, input resistance 330Ω CMOS input method Input signal voltage: H = 4.0 to 5.5V, L = 0 to 0.5V Input signal voltage: H = 4.0 to 5.5V, L = 0 to 0.5V					
	6							
Step angle selection input (S. SEL)	—	10	By the input S or SEL signal, the step angle of full-step or half-step is selected. "H" level: — Half-step "L" level — Full-step CMOS input method Input signal voltage: H = 4.0 to 5.5V, L = 0 to 0.5V					
Phase origin monitor output signal (MON)	7	11	Indicates ON when the exciting phase is at the origin position. In the full-step, outputs once for every 4 pulses. In the half-step, outputs once for every 8 pulse From the photo coupler by the open collector output (ON at the phase origin). From the transistor by the open collector output (ON at the phase origin). Output specification: Vceo=30V MAX. Ic=5mA MAX. Output specification: Vceo=30V MAX. Ic=5mA MAX.					
	8							

- Stepping motor rotation in the CW direction means clockwise rotation when facing the output shaft (the flange side) of the stepping motor. CCW direction means counterclockwise rotation when facing the same side.
- Set the DIP switch as follows when using the step angle selection function by signal input.

EX1	EX2	EX3
OFF	ON	ON

- When the half-step is selected by the step angle selection signal, its torque ought to be 70% of that for the full-step.

Operation, Connection, and Function

PMM-MD-23210-10(Photo coupler input method)
PMM-MD-23220-21(Photo coupler input method)
PMM-MD-23220-10(Photo coupler input method)

● Input circuit configuration (CW, CCW)

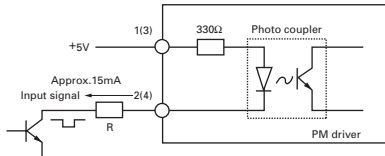

- Pulse duty 50% MAX.
- When the crest value of the input signal is 5V, the external limit resistance R must be 0Ω.
When the crest value of the input signal exceeds 5V, use the external limit resistance R to limit the input current to approximately 15mA.

Input signal specifications

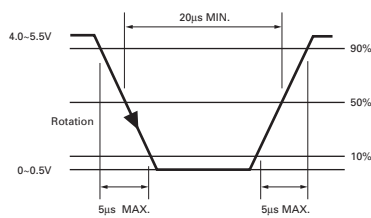

Timing of command pulse

- 2-input mode (CW, CCW)

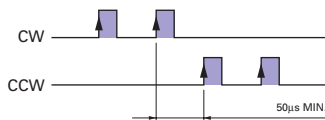

- The internal photo coupler turns ON within the and, at its rising edge to ON, the internal circuit (stepping motor) is activated.
- When applying the pulse to CW, turn OFF the CCW side internal photo coupler.
- When applying the pulse to CCW, turn OFF the CW side internal photo coupler.

- Pulse and direction mode (CK,U/D)

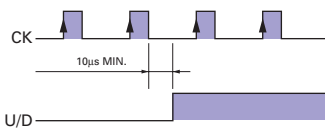

- The internal photo coupler turns ON within the and, at the rising edge to ON of the CK photo coupler, the internal circuit (stepping motor) is activated.
- Switching the input signal U/D shall be performed while the internal photo coupler on the CK side is OFF.

PMM-MD-23211-10(CMOS input method)
PMM-MD-23221-21(CMOS input method)
PMM-MD-23221-10(CMOS input method)

● Input circuit configuration (CW, CCW)

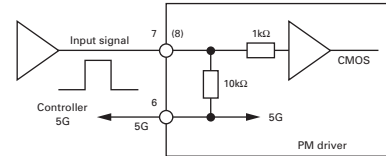

- Pulse duty 50% MAX.

Input signal specifications

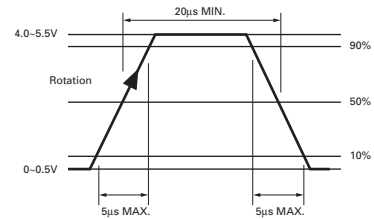

Timing of command pulse

- 2-input mode (CW, CCW)

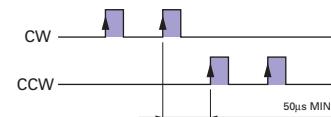

- The "H" level is input at and, at its rising edge to "H" level, the internal circuit (stepping motor) is activated.
- When applying the pulse to CW, turn OFF the CCW side internal photo coupler.
- When applying the pulse to CCW, turn OFF the CW side internal photo coupler.

- Pulse and direction mode (CK,U/D)

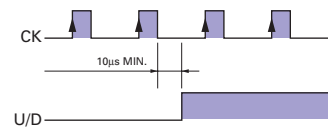

- The "H" level is input for and, at its rising edge to "H" level, the internal circuit (stepping motor) is activated.
- Switching the input signal U/D should be performed while the input level on the CK side is "L".

Operation, Connection, and Function

PMM-MD-23210-10(Photo coupler input method)
PMM-MD-23220-21(Photo coupler input method)
PMM-MD-23220-10(Photo coupler input method)

● Input circuit configuration (PD)

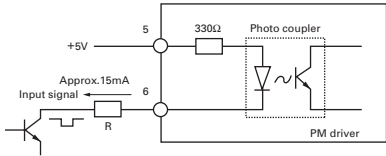

- When the crest value of the input signal is 5V, the external limit resistance R must be 0Ω. When the crest value of the input signal exceeds 5V, use the external limit resistance R to limit the input current to approximately 15mA.

● Output circuit configuration (MON)

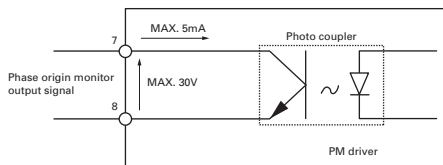

- Phase origin monitor output signal
 Contact mode: Open collector output of the photo coupler
 Contact capacity: DC30V 5mA MAX.

Timing of MON output (in 1-division setting)

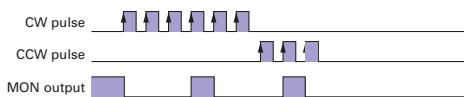

- The internal photo coupler or transistor turns ON at ■.

PMM-MD-23211-10(CMOS input method)
PMM-MD-23221-21(CMOS input method)
PMM-MD-23221-10(CMOS input method)

● Input circuit configuration (PD, S, SEL)

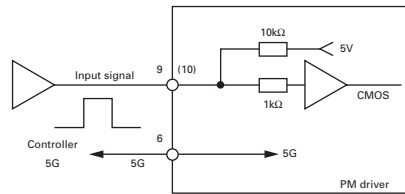

- When the crest value of the input signal is 5V, the external limit resistance R must be 0Ω. When the crest value of the input signal exceeds 5V, use the external limit resistance R to limit the input current to approximately 15mA.

● Output circuit configuration (MON)

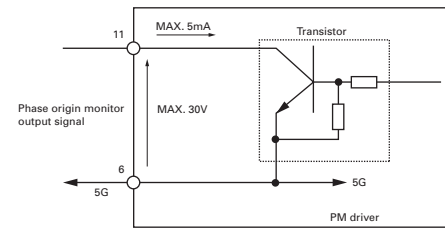

- Phase origin monitor output signal
 Contact mode: Open collector output by the transistor
 Contact capacity: DC30V 5mA MAX.

Timing of MON output (in 1-division setting)

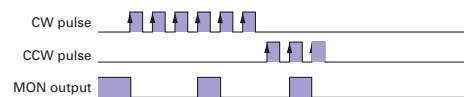

- The internal photo coupler or transistor turns ON at ■.

PMM-BA-4803
PMM-BA-4804

PMM-UA-4303
PMM-UA-4304

PMM-MD-23210-10/23211-10
PMM-MD-23220-21/23221-21
PMM-MD-23220-10/23221-10

PMM-MD-23120

Operation, Connection, and Function

● PM driver component names

PMM-MD-23210-10(Photo coupler input method)
PMM-MD-23220-21(Photo coupler input method)
PMM-MD-23220-10(Photo coupler input method)

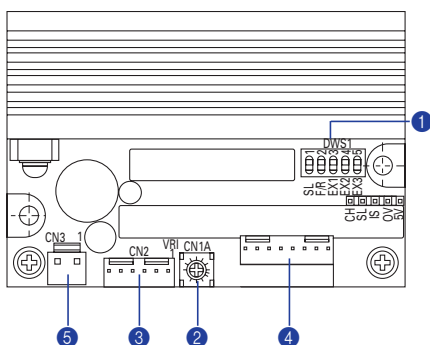

PMM-MD-23211-10(CMOS input method)
PMM-MD-23221-21(CMOS input method)
PMM-MD-23221-10(CMOS input method)

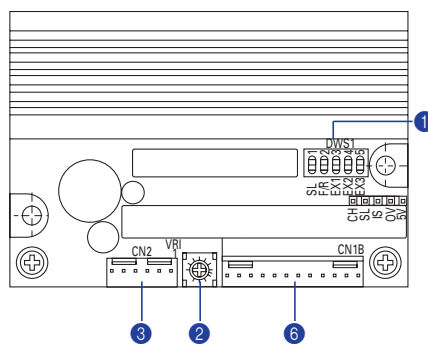

① Function selection DIP switch pack --- All models in common

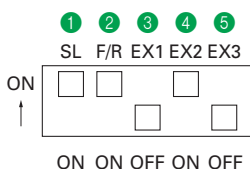

- The factory setting is shown in the figure above.
- Turn off the power supply to the PM driver before changing DIP switch setting.

① SL (Auto current down selection)
 Select Auto current down function selection.

SL	Auto current down
ON	Approx 50% of current rating when stopped
OFF	100% of current rating when stopped

- The temperature increase in the motor driver can be controlled by setting SL to On(approx.50% of the rated current).
- The output torque when SL is On(approx. 50% of the rated current) is approx.50% of the that when SL is Off (100% of the rated current).

② F/R (Pulse-input method selection)
 Select the pulse-input method.

F/R	Pulse-input mode
ON	2-input mode (CW, CCW)
OFF	Pulse and direction mode (CK, U/D)

③ ④ ⑤ EX1, EX2, EX3 (Step angle setting selection)
 Enables selection of division numbers of basic step angles when micro step is driven.

EX1	EX2	EX3	Number of divisions
ON	ON	ON	1 (Full step)
OFF	ON	OFF	2 (Half step)
ON	OFF	OFF	4
OFF	OFF	OFF	8

② Operating-current adjustment controller (VR1) --- All models in common

The controller is to adjust operating-current of the stepping motor.

The factory setting is at the rated current of standard combined stepping motor.

③ Connector (CN2) --- All models in common

Connects motor power line

④ Connector (CN1A) --- Photo coupler input method

Connects I/O line

⑤ Connector (CN3) --- Photo coupler input method

Connects DC power line

⑥ Connector (CN1B) --- CMOS input method

Connect I/O line and DC power line

Operation, Connection, and Function

● External wiring diagram

PMM-MD-23210-10(Photo coupler input method)
PMM-MD-23220-21(Photo coupler input method)
PMM-MD-23220-10(Photo coupler input method)

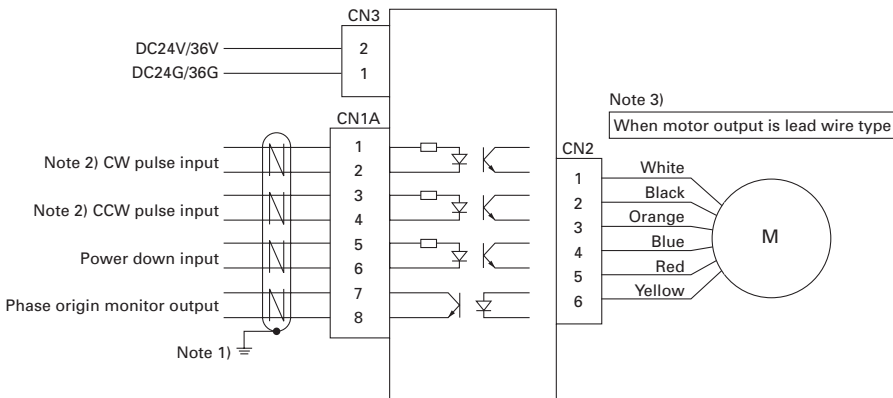

Note 3)
When motor output is connector type

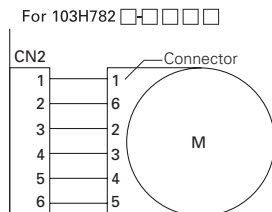
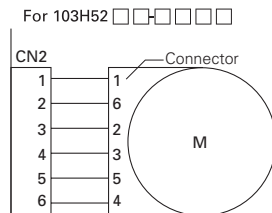
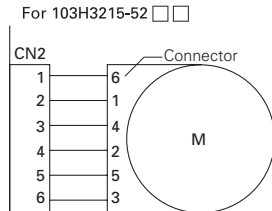

● Connectors used

PM Diver side		Corresponding connector model number	Maker
Use	Model number		
For I/O signal (CN1A)	5045-08AG	Corresponding housing: 5051-08 Corresponding contact: 2759PBG	Molex
For stepping motor (CN2)	5045-06A	Corresponding housing: 5051-06 Corresponding contact: 5159PBT	Molex
For DC power source (CN3)	5273-02A	Corresponding housing: 5195-02 Corresponding contact: 5194PBT	Molex

• For the applicable connector, the client is requested to procure or place orders with us from the optional connector sets or the connector cables we offer. (Refer to the page 41.)

PMM-MD-23211-10(CMOS input method)
PMM-MD-23221-21(CMOS input method)
PMM-MD-23221-10(CMOS input method)

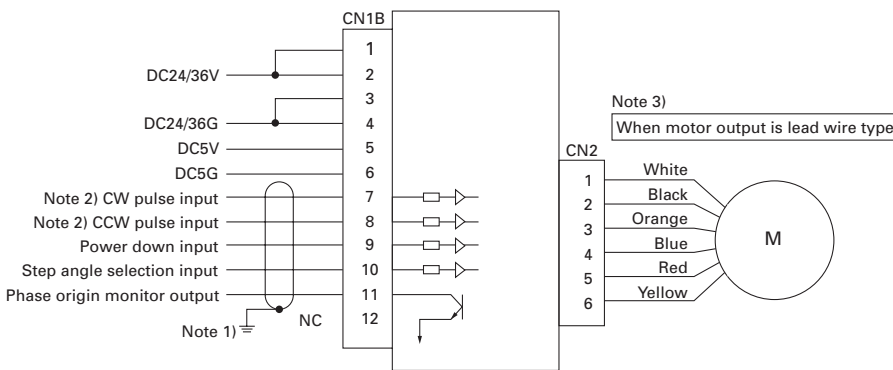

Note 3)
When motor output is connector type

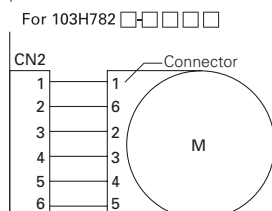
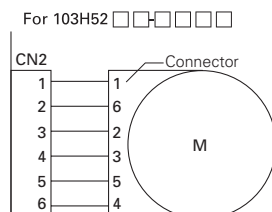
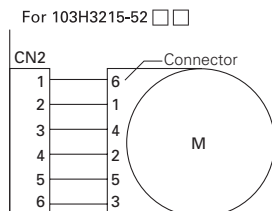

● Connectors used

PM Diver side		Corresponding connector model number	Maker
Use	Model number		
For DC power source and I/O signals (CN1B)	5045-12AG	Corresponding housing: 5051-12 Corresponding contact: 2759PBG	Molex
For stepping motor (CN2)	5045-06A	Corresponding housing: 5051-06 Corresponding contact: 5159PBT	Molex

• For the applicable connector, the client is requested to procure or place orders with us from the optional connector sets or the connector cables we offer. (Refer to the page 41.)

Note 1) Use twist pair shielded cables.

Note 2) Selection is possible between "2-input mode (CW, CCW)" and "Pulse and direction mode (CK, U/D)" by the function selection switch F/R.

Note 3) Motor output of stepping motor models 103H3215, 103H52 □□, 103H782 □ are connector type.

Motor side pin number and driver side connector(CN2) pin number is not match. So please be careful when connecting.

PMM-BA-4803
PMM-BA-4804
PMM-UA-4303
PMM-UA-4304
PMM-MD-23210-10/23211-10
PMM-MD-23220-21/23221-21
PMM-MD-23220-10/23221-10
PMM-MD-23120

Dimensions [Unit:mm(inch)]

PMM-MD-23210(Photo coupler input method)

PMM-MD-23220-21(Photo coupler input method)

PMM-MD-23220-10(Photo coupler input method)

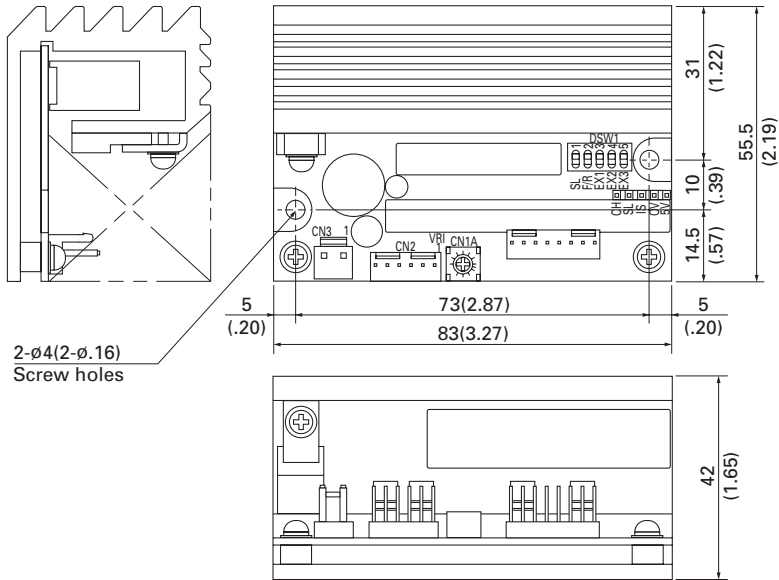

PMM-MD-23211-10(CMOS input method)

PMM-MD-23221-21(CMOS input method)

PMM-MD-23221-10(CMOS input method)

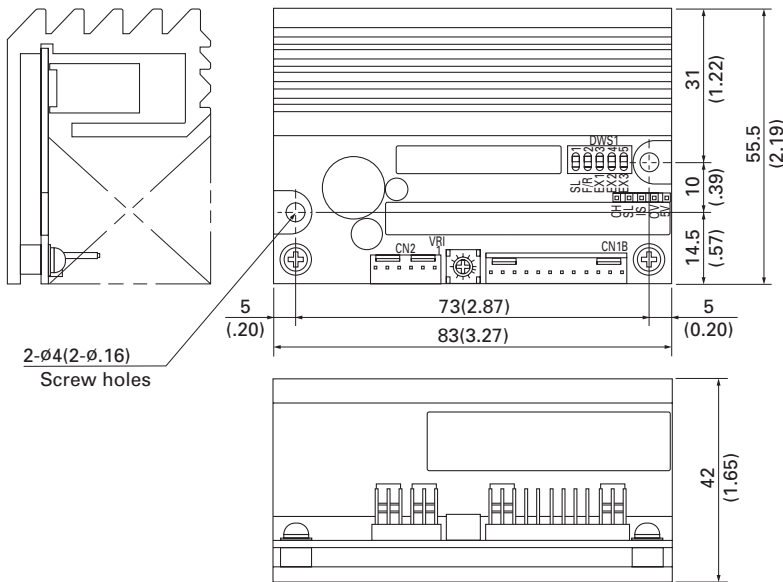

Mounting direction and mounting position

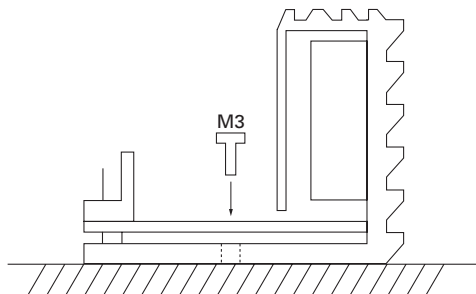

- Install the PM driver vertically.
- As shown in the figure, fix the PM driver by using the M3 screws through two fitting holes (2-φ.4) on the bottom surface of PM driver (no fitting metals are necessary).

Pulse Rate-Torque Characteristics/Pulse Rate-Power Current Characteristics

fs: No load maximum starting pulse rate. ■ 1-division is specified ■ 2-division is specified

PMM-MD-23220-21 PMM-MD-23221-21

● 103H5209-04 □□ : 24V

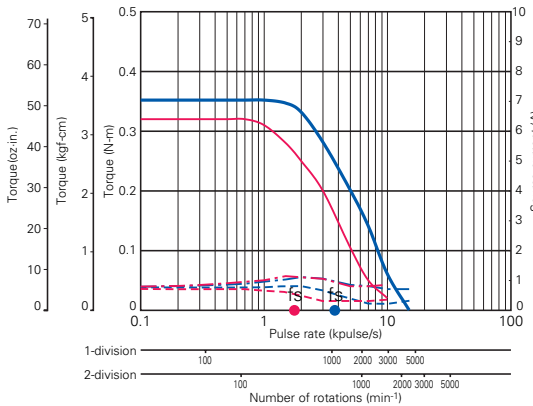

Source voltage: DC24V, Operating current : 1.2A/phase
 — Pull-Out torque ($J_{L1}=0.94 \times 10^{-4} \text{kg}\cdot\text{m}^2$ (5.14 oz-in²) Use the rubber coupling)
 - - - Source current (TL=MAX), - - - Source current (TL=0)

● 103H5209-04 □□ : 36V

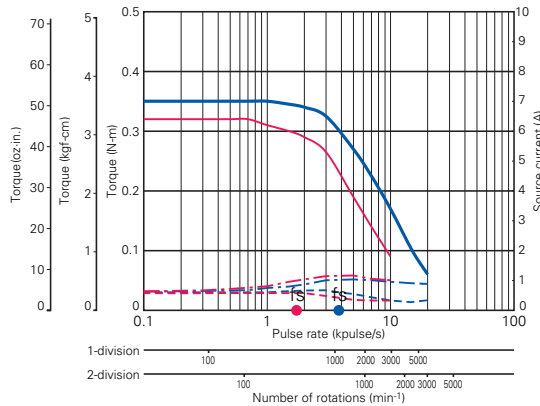

Source voltage: DC36V, Operating current : 1.2A/phase
 — Pull-Out torque ($J_{L1}=0.94 \times 10^{-4} \text{kg}\cdot\text{m}^2$ (5.14 oz-in²) Use the rubber coupling)
 - - - Source current (TL=MAX), - - - Source current (TL=0)

● 103H5210-04 □□ : 24V

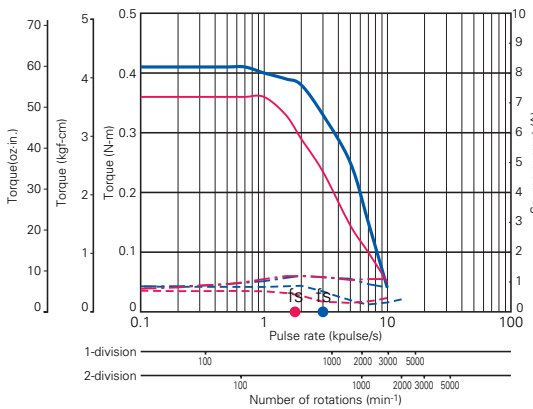

Source voltage: DC24V, Operating current : 1.2A/phase
 — Pull-Out torque ($J_{L1}=0.94 \times 10^{-4} \text{kg}\cdot\text{m}^2$ (5.14 oz-in²) Use the rubber coupling)
 - - - Source current (TL=MAX), - - - Source current (TL=0)

● 103H5210-04 □□ : 36V

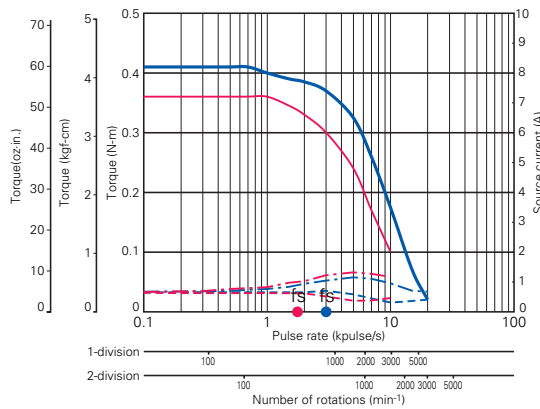

Source voltage: DC36V, Operating current : 1.2A/phase
 — Pull-Out torque ($J_{L1}=0.94 \times 10^{-4} \text{kg}\cdot\text{m}^2$ (5.14 oz-in²) Use the rubber coupling)
 - - - Source current (TL=MAX), - - - Source current (TL=0)

PMM-MD-23220-10 PMM-MD-23221-10

● 103H6701-04 □□ : 24V

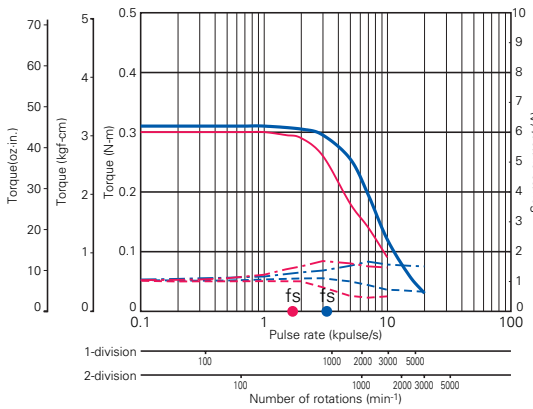

Source voltage: DC24V, Operating current : 1.2A/phase
 — Pull-Out torque ($J_{L1}=0.94 \times 10^{-4} \text{kg}\cdot\text{m}^2$ (5.14 oz-in²) Use the rubber coupling)
 - - - Source current (TL=MAX), - - - Source current (TL=0)

● 103H6701-04 □□ : 36V

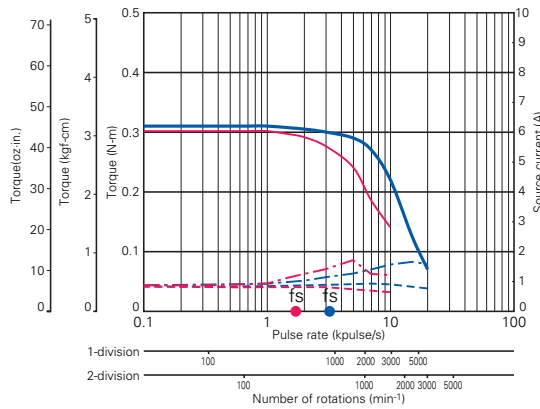

Source voltage: DC36V, Operating current : 1.2A/phase
 — Pull-Out torque ($J_{L1}=0.94 \times 10^{-4} \text{kg}\cdot\text{m}^2$ (5.14 oz-in²) Use the rubber coupling)
 - - - Source current (TL=MAX), - - - Source current (TL=0)

PMM-BA-4803
 PMM-BA-4804
 PMM-UA-4303
 PMM-UA-4304
 PMM-MD-2320-10/2321-10
 PMM-MD-2320-21/2321-21
 PMM-MD-2320-10/2321-10
 PMM-MD-23120

Pulse Rate-Torque Characteristics/Pulse Rate-Power Current Characteristics

fs: No load maximum starting pulse rate. ■ 1-division is specified ■ 2-division is specified

PMM-MD-23220-10 PMM-MD-23221-10

● 103H6703-04 □ □ : 24V

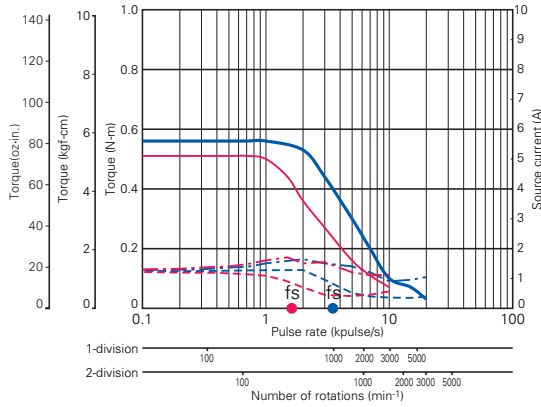

Source voltage: DC24V, Operating current : 2A/phase
 — Pull-Out torque [$JL_1=0.94 \times 10^{-4} \text{kg}\cdot\text{m}^2$ (5.14 oz-in²) Use the rubber coupling]
 - - - Source current (TL=MAX), - - - Source current (TL=0)

● 103H6703-04 □ □ : 36V

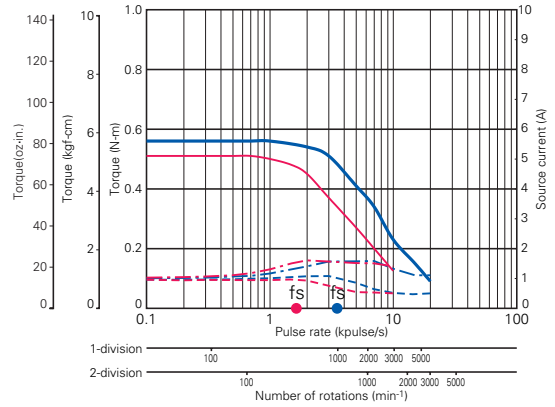

Source voltage: DC36V, Operating current : 2A/phase
 — Pull-Out torque [$JL_1=0.94 \times 10^{-4} \text{kg}\cdot\text{m}^2$ (5.14 oz-in²) Use the rubber coupling]
 - - - Source current (TL=MAX), - - - Source current (TL=0)

● 103H6704-04 □ □ : 24V

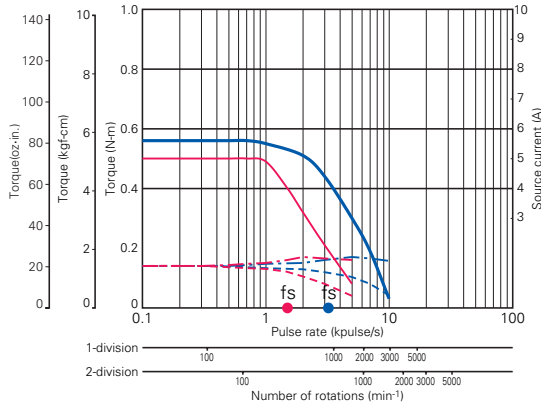

Source voltage: DC24V, Operating current : 2A/phase
 — Pull-Out torque [$JL_1=0.94 \times 10^{-4} \text{kg}\cdot\text{m}^2$ (5.14 oz-in²) Use the rubber coupling]
 - - - Source current (TL=MAX), - - - Source current (TL=0)

● 103H6704-04 □ □ : 36V

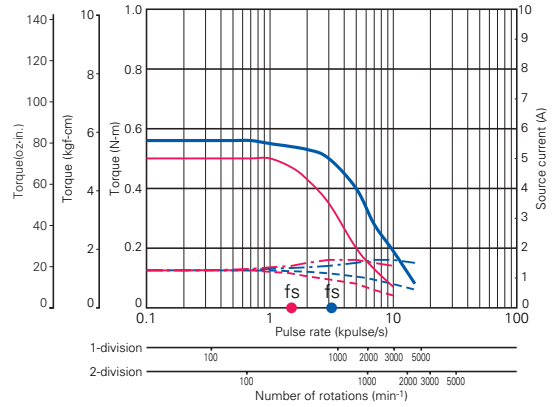

Source voltage: DC36V, Operating current : 2A/phase
 — Pull-Out torque [$JL_1=0.94 \times 10^{-4} \text{kg}\cdot\text{m}^2$ (5.14 oz-in²) Use the rubber coupling]
 - - - Source current (TL=MAX), - - - Source current (TL=0)

● 103H7121-04 □ □ : 24V

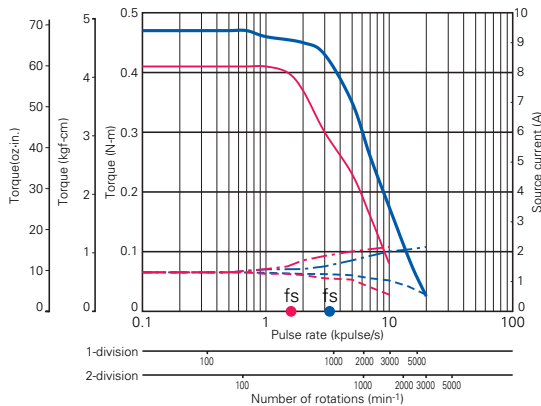

Source voltage: DC24V, Operating current : 2A/phase
 — Pull-Out torque [$JL_1=0.94 \times 10^{-4} \text{kg}\cdot\text{m}^2$ (5.14 oz-in²) Use the rubber coupling]
 - - - Source current (TL=MAX), - - - Source current (TL=0)

● 103H7121-04 □ □ : 36V

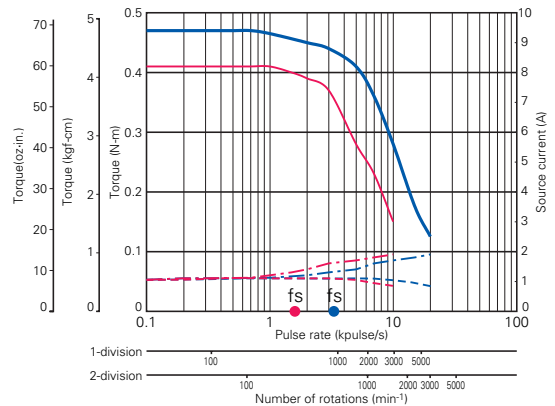

Source voltage: DC36V, Operating current : 2A/phase
 — Pull-Out torque [$JL_1=0.94 \times 10^{-4} \text{kg}\cdot\text{m}^2$ (5.14 oz-in²) Use the rubber coupling]
 - - - Source current (TL=MAX), - - - Source current (TL=0)

Pulse Rate-Torque Characteristics/Pulse Rate-Power Current Characteristics

PMM-MD-23220-10 PMM-MD-23221-10

fs: No load maximum starting pulse rate. ■ 1-division is specified ■ 2-division is specified

● 103H7123-04 □□ : 24V

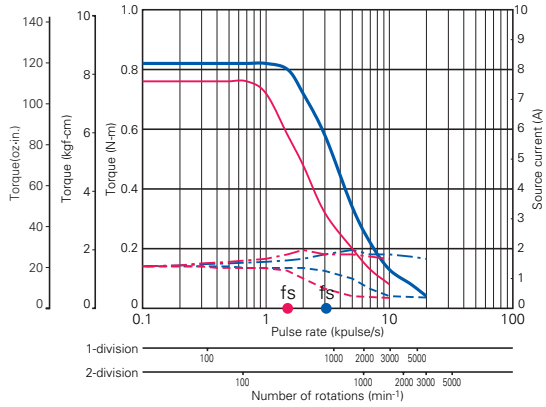

Source voltage: DC24V, Operating current : 2A/phase
 — Pull-Out torque [$J_{L1}=2.6 \times 10^{-4} \text{kg}\cdot\text{m}^2$ (14.22 oz-in²) Use the rubber coupling]
 - - - Source current (TL=MAX), - - - Source current (TL=0)

● 103H7123-04 □□ : 36V

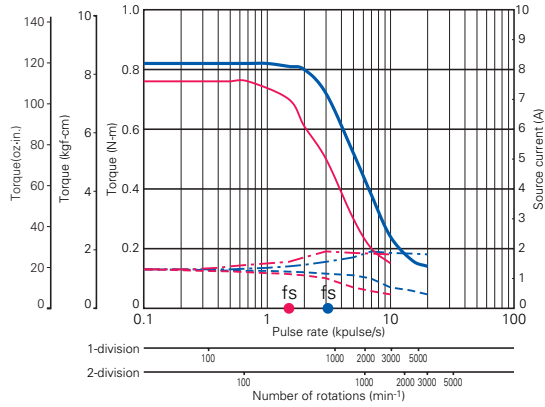

Source voltage: DC24V, Operating current : 2A/phase
 — Pull-Out torque [$J_{L1}=2.6 \times 10^{-4} \text{kg}\cdot\text{m}^2$ (14.22 oz-in²) Use the rubber coupling]
 - - - Source current (TL=MAX), - - - Source current (TL=0)

● 103H7124-04 □□ : 24V

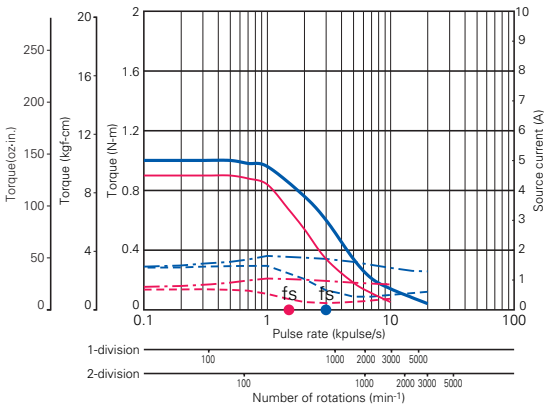

Source voltage: DC24V, Operating current : 2A/phase
 — Pull-Out torque [$J_{L1}=2.6 \times 10^{-4} \text{kg}\cdot\text{m}^2$ (14.22 oz-in²) Use the rubber coupling]
 - - - Source current (TL=MAX), - - - Source current (TL=0)

● 103H7124-04 □□ : 36V

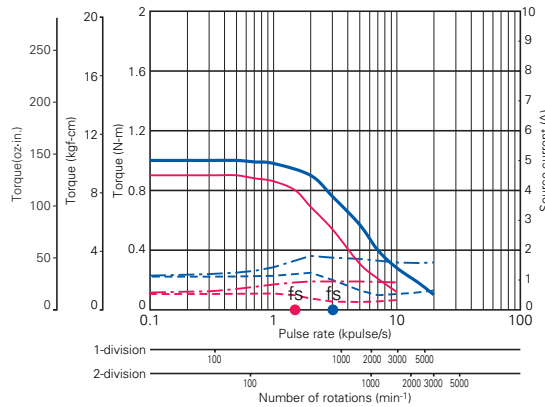

Source voltage: DC24V, Operating current : 2A/phase
 — Pull-Out torque [$J_{L1}=2.6 \times 10^{-4} \text{kg}\cdot\text{m}^2$ (14.22 oz-in²) Use the rubber coupling]
 - - - Source current (TL=MAX), - - - Source current (TL=0)

● 103H7126-04 □□ : 24V

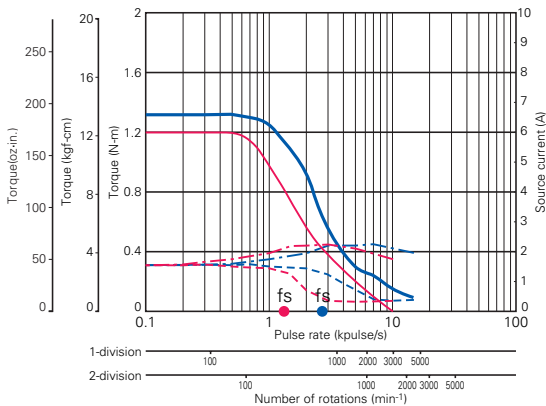

Source voltage: DC24V, Operating current : 2A/phase
 — Pull-Out torque [$J_{L1}=2.6 \times 10^{-4} \text{kg}\cdot\text{m}^2$ (14.22 oz-in²) Use the rubber coupling]
 - - - Source current (TL=MAX), - - - Source current (TL=0)

● 103H7126-04 □□ : 36V

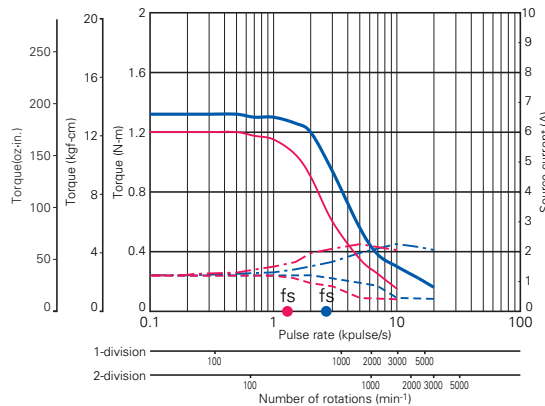

Source voltage: DC24V, Operating current : 2A/phase
 — Pull-Out torque [$J_{L1}=2.6 \times 10^{-4} \text{kg}\cdot\text{m}^2$ (14.22 oz-in²) Use the rubber coupling]
 - - - Source current (TL=MAX), - - - Source current (TL=0)

PMM-BA-4803
PMM-BA-4804
PMM-UA-4303
PMM-UA-4304
PMM-MD-23210-10
PMM-MD-23210-10
PMM-MD-23210-10
PMM-MD-23210-10
PMM-MD-23120

Pulse Rate-Torque Characteristics/Pulse Rate-Power Current Characteristics

fs: No load maximum starting pulse rate. ■ 1-division is specified ■ 2-division is specified

PMM-MD-23220-10 PMM-MD-23221-10

● 103H7821-04 □ □ : 24V

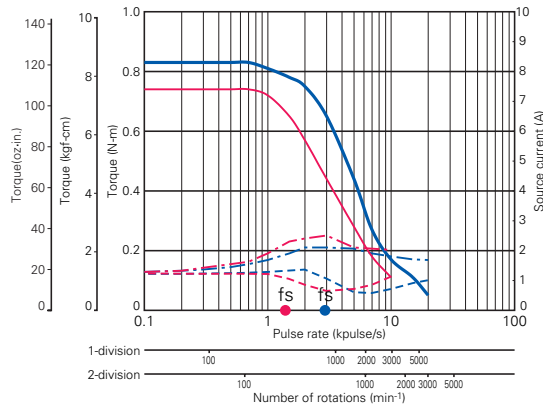

Source voltage: DC24V, Operating current 2A/phase
 — Pull-Out torque [$JL_1=2.6 \times 10^{-4} \text{kg}\cdot\text{m}^2$ (14.22 oz-in²) Use the rubber coupling]
 - - - Source current (TL=MAX), - - - Source current (TL=0)

● 103H7821-04 □ □ : 36V

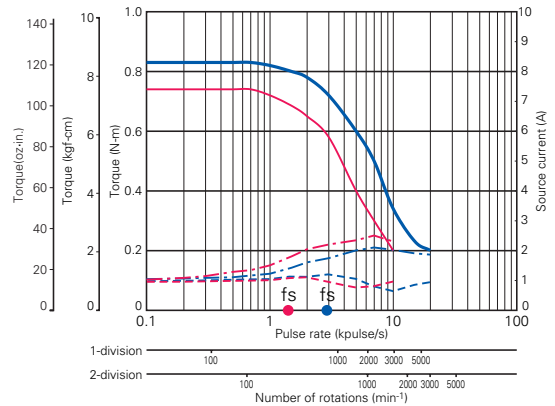

Source voltage: DC24V, Operating current 2A/phase
 — Pull-Out torque [$JL_1=2.6 \times 10^{-4} \text{kg}\cdot\text{m}^2$ (14.22 oz-in²) Use the rubber coupling]
 - - - Source current (TL=MAX), - - - Source current (TL=0)

● 103H7822-04 □ □ : 24V

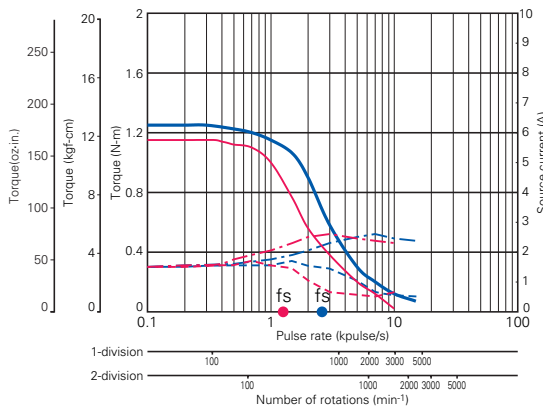

Source voltage: DC24V, Operating current 2A/phase
 — Pull-Out torque [$JL_1=2.6 \times 10^{-4} \text{kg}\cdot\text{m}^2$ (14.22 oz-in²) Use the rubber coupling]
 - - - Source current (TL=MAX), - - - Source current (TL=0)

● 103H7822-04 □ □ : 36V

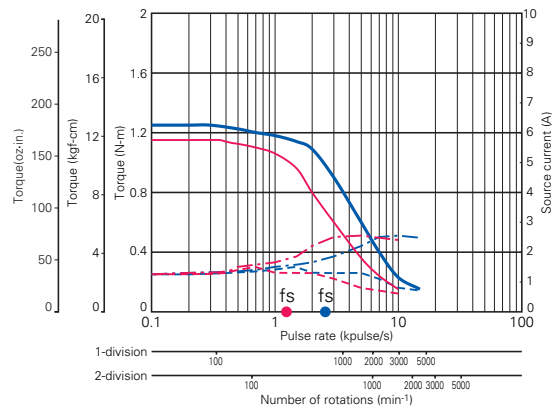

Source voltage: DC24V, Operating current 2A/phase
 — Pull-Out torque [$JL_1=2.6 \times 10^{-4} \text{kg}\cdot\text{m}^2$ (14.22 oz-in²) Use the rubber coupling]
 - - - Source current (TL=MAX), - - - Source current (TL=0)

● 103H7823-04 □ □ : 24V

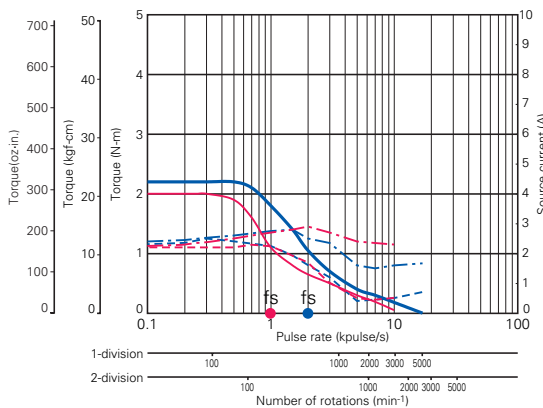

Source voltage: DC24V, Operating current 2A/phase
 — Pull-Out torque [$JL_1=7.4 \times 10^{-4} \text{kg}\cdot\text{m}^2$ (40.46 oz-in²) Use the rubber coupling]
 - - - Source current (TL=MAX), - - - Source current (TL=0)

● 103H7823-04 □ □ : 36V

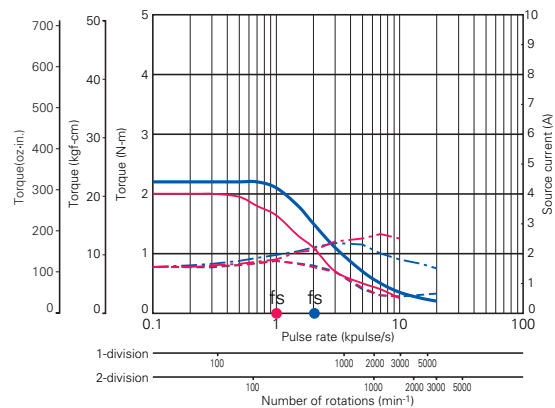

Source voltage: DC24V, Operating current 2A/phase
 — Pull-Out torque [$JL_1=7.4 \times 10^{-4} \text{kg}\cdot\text{m}^2$ (40.46 oz-in²) Use the rubber coupling]
 - - - Source current (TL=MAX), - - - Source current (TL=0)

Pulse Rate-Torque Characteristics/Pulse Rate-Power Current Characteristics

PMM-MD-23220-10 PMM-MD-23221-10

fs: No load maximum starting pulse rate. ■ 1-division is specified ■ 2-division is specified

● 103H8221-04 □ □ : 24V

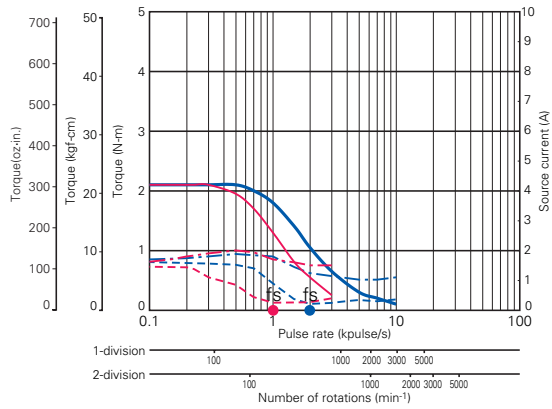

Source voltage: DC24V, Operating current : 2A/phase
 — Pull-Out torque [$JL1=7.4 \times 10^{-4} \text{kg}\cdot\text{m}^2$ (40.46 oz-in²) Use the rubber coupling]
 - - - Source current (TL=MAX), - - - Source current (TL=0)

● 103H8221-04 □ □ : 36V

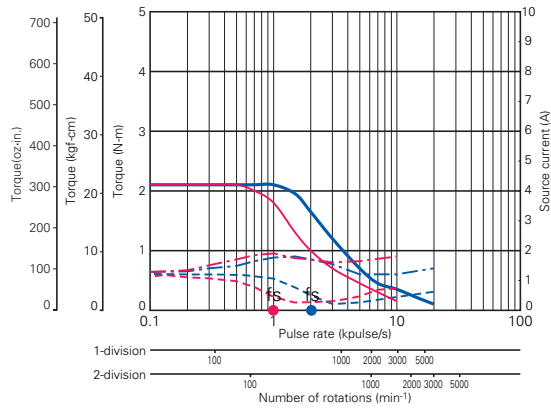

Source voltage: DC24V, Operating current : 2A/phase
 — Pull-Out torque [$JL1=7.4 \times 10^{-4} \text{kg}\cdot\text{m}^2$ (40.46 oz-in²) Use the rubber coupling]
 - - - Source current (TL=MAX), - - - Source current (TL=0)

● 103H8222-04 □ □ : 24V

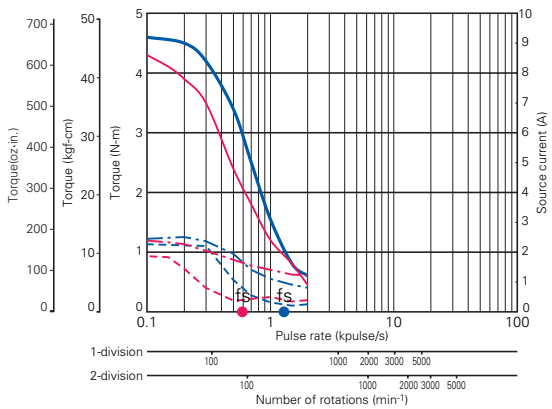

Source voltage: DC24V, Operating current : 2A/phase
 — Pull-Out torque [$JL1=15.3 \times 10^{-4} \text{kg}\cdot\text{m}^2$ (83.65 oz-in²) Use the rubber coupling]
 - - - Source current (TL=MAX), - - - Source current (TL=0)

● 103H8222-04 □ □ : 36V

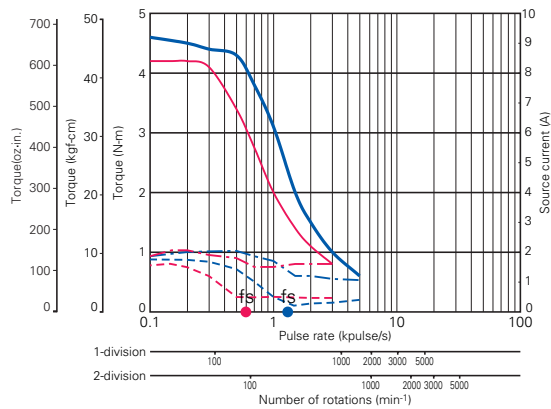

Source voltage: DC24V, Operating current : 2A/phase
 — Pull-Out torque [$JL1=15.3 \times 10^{-4} \text{kg}\cdot\text{m}^2$ (83.65 oz-in²) Use the rubber coupling]
 - - - Source current (TL=MAX), - - - Source current (TL=0)

● 103H8223-04 □ □ : 24V

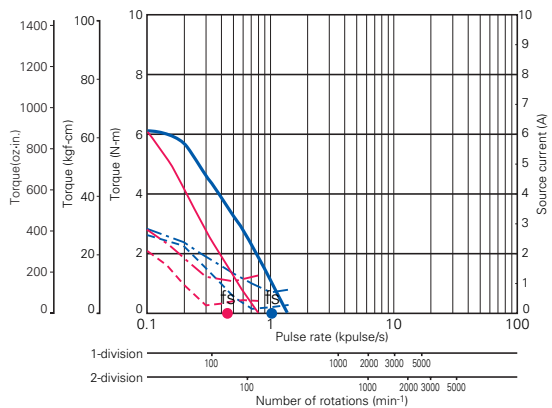

Source voltage: DC24V, Operating current : 2A/phase
 — Pull-Out torque [$JL1=15.3 \times 10^{-4} \text{kg}\cdot\text{m}^2$ (83.65 oz-in²) Use the rubber coupling]
 - - - Source current (TL=MAX), - - - Source current (TL=0)

● 103H8223-04 □ □ : 36V

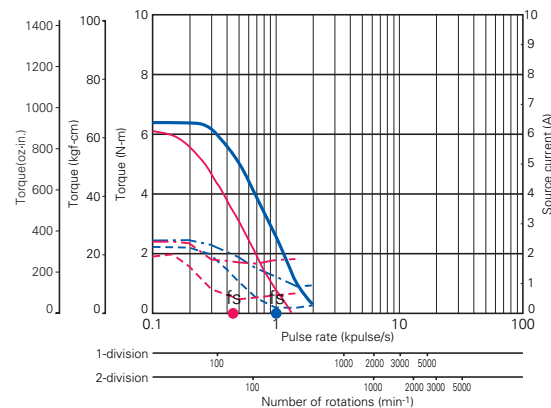

Source voltage: DC24V, Operating current : 2A/phase
 — Pull-Out torque [$JL1=15.3 \times 10^{-4} \text{kg}\cdot\text{m}^2$ (83.65 oz-in²) Use the rubber coupling]
 - - - Source current (TL=MAX), - - - Source current (TL=0)

PMM-BA-4803
 PMM-BA-4804
 PMM-UA-4303
 PMM-UA-4304
 PMM-MD-23210-10
 PMM-MD-23220-10
 PMM-MD-23221-10
 PMM-MD-23120

Option

● Connector set

PMM-MD-23210-10 (Photo coupler input method)

Model	Used for	Contents of set	Quantity	Manufacturer	Applicable wire size	Crimp tool number
PM-AP-009	I/O signal (CN1A)	Applicable housing:5051-08	1	Molex	AWG22~28	JHTR2262A JHTR2262J
		Applicable contact:2759PBGL	8			
PM-AP-053	Stepping motor (CN2)	Applicable housing:5051-06	1	Molex	AWG24~28	JHTR2262A JHTR2262J
		Applicable contact:5159PBTL	6			
		Applicable housing:PHR-6	1	J.S.T. MFG. CO., LTD.		YRS-240
		Applicable contact:SPH-002T-P0.5S	6			
PM-AP-013	DC power supply (CN3)	Applicable housing:5195-02	1	Molex	AWG18~24	JHTR5904
		Applicable contact:5194PBTL	2			

PMM-MD-23211-10 (CMOS input method)

Model	Used for	Contents of set	Quantity	Manufacturer	Applicable wire size	Crimp tool number
PM-AP-011	Power supply I/O signal (CN1B)	Applicable housing:5051-12	1	Molex	AWG22~28	JHTR2262A JHTR2262J
		Applicable contact:2759PBGL	12			
PM-AP-053	Stepping motor (CN2)	Applicable housing:5051-06	1	Molex	AWG24~28	JHTR2262A JHTR2262J
		Applicable contact:5159PBTL	6			
		Applicable housing:PHR-6	1	J.S.T. MFG. CO., LTD.		YRS-240
		Applicable contact:SPH-002T-P0.5S	6			

PMM-MD-23220-21 (Photo coupler input method)

Model	Used for	Contents of set	Quantity	Manufacturer	Applicable wire size	Crimp tool number
PM-AP-009	I/O signal (CN1A)	Applicable housing:5051-08	1	Molex	AWG22~28	JHTR2262A JHTR2262J
		Applicable contact:2759PBGL	8			
PM-AP-054	Stepping motor (CN2)	Applicable housing:5051-06	1	Molex	AWG22~28	JHTR2262A JHTR2262J
		Applicable contact:5159PBTL	6			
		Applicable housing:EHR-6	1	J.S.T. MFG. CO., LTD.		YRS-260
		Applicable contact:SEH-001T-P0.6	6			
PM-AP-013	DC Power supply (CN3)	Applicable housing:5195-02	1	Molex	AWG18~24	JHTR5904
		Applicable contact:5194PBTL	2			

PMM-MD-23221-21 (CMOS input method)

Model	Used for	Contents of set	Quantity	Manufacturer	Applicable wire size	Crimp tool number
PM-AP-011	Power supply I/O signal (CN1B)	Applicable housing:5051-12	1	Molex	AWG22~28	JHTR2262A JHTR2262J
		Applicable contact:2759PBGL	12			
PM-AP-054	Stepping motor (CN2)	Applicable housing:5051-06	1	Molex	AWG22~28	JHTR2262A JHTR2262J
		Applicable contact:5159PBTL	6			
		Applicable housing:EHR-6	1	J.S.T. MFG. CO., LTD.		YRS-260
		Applicable contact:SEH-001T-P0.6	6			

PMM-MD-23220-10 (Photo coupler input method)

Model	Used for	Contents of set	Quantity	Manufacturer	Applicable wire size	Crimp tool number
PM-AP-009	I/O signal (CN1A)	Applicable housing:5051-08	1	Molex	AWG22~28	JHTR2262A JHTR2262J
		Applicable contact:2759PBGL	8			
PM-AP-047 H782 □ type	Stepping motor (CN2)	Applicable housing:5051-06	1	Molex	AWG22	JHTR2262A
		Applicable contact:5159PBTL	6			
		Applicable housing:VHR-6N	1	J.S.T. MFG. CO., LTD.		YC-160R
		Applicable contact:SVH-21T-P1.1	6			
PM-AP-008 Other types		Applicable housing:5051-06	1	Molex	AWG22	JHTR2262A
		Applicable contact:5159PBTL	6			
PM-AP-013	DC Power supply (CN3)	Applicable housing:5195-02	1	Molex	AWG18~24	JHTR5904
		Applicable contact:5194PBTL	2			

PMM-MD-23221-10 (CMOS input method)

Model	Used for	Contents of set	Quantity	Manufacturer	Applicable wire size	Crimp tool number
PM-AP-011	Power supply I/O signal (CN1B)	Applicable housing:5051-12	1	Molex	AWG22~28	JHTR2262A JHTR2262J
		Applicable contact:2759PBGL	12			
PM-AP-047 H782 □ type	Stepping motor (CN2)	Applicable housing:5051-06	1	Molex	AWG22	JHTR2262A
		Applicable contact:5159PBTL	6			
		Applicable housing:VHR-6N	1	J.S.T. MFG. CO., LTD.		YC-160R
		Applicable contact:SVH-21T-P1.1	6			
PM-AP-008 Other types		Applicable housing:5051-06	1	Molex	AWG22	JHTR2262A
		Applicable contact:5159PBTL	6			

Option

● Connector cable

PMM-MD-23210-10 (Photo coupler input method)

PMM-MD-23220-21 (Photo coupler input method)

PMM-MD-23220-10 (Photo coupler input method)

Model	Used for
PM-C08S0100-01	I/O signal (CN1A) connector cable
PM-C02P0100-02	DC power supply (CN3) connector cable
PM-C06M0100-□□	Stepping motor (CN2) connector cable

PMM-MD-23211-10 (CMOS input method)

PMM-MD-23221-21 (CMOS input method)

PMM-MD-23221-10 (CMOS input method)

Model	Used for
PM-C12T0100-01	DC power supply, I/O signal(CN1B) connector cable
PM-C06M0100-□□	Stepping motor (CN2) connector cable

□□... is 01, 03, 05 or 06. (Refer to separate table 1.)

- The connector cables consist of each interface connector with a 1m cable assembled.

Model No. of stepping motor cable (Separate Table 1)

Serial No.	Stepping motor model No.
01	103H6701-04□□
	103H6703-04□□
	103H6704-53□□
	103H7121-04□□
	103H7123-04□□
	103H7124-04□□
	103H7126-04□□
	103H8221-04□□
	103H8222-04□□
	103H8223-04□□

Serial No.	Stepping motor model No.
03	103H7821-04□□
	103H7822-04□□
	103H7823-04□□
05	103H3215-52□□
	103H5205-04□□
06	103H5208-04□□
	103H5209-04□□
	103H5210-04□□

● Cable 1 (Power source cable)

Driver side	
Pin No.	Color
1	Black
2	White

Model of cable	Length
PM-C02P0100-02	1m(39.37inch)

● Cable 2(Power source, signal cable)

Driver side	
Pin No.	Color
1	White
2	
3	Black
4	
5	White
6	Black
7	Blue
8	
9	
10	
11	
12	

Model of cable	Length
PM-C12T0100-01	1m(39.37inch)