

Rubber Endstop Buffers · cylindrical

25150.0376



Product Description

To be used as an elastic end-stop, bearing foot etc.
The hardness is $55 \pm 5^\circ$ shore A. Further shore hardnesses ($40 \pm 5^\circ$ shore A and $70 \pm 5^\circ$ shore A) on request.

Material

Support washer

- Steel, zinc-plated, blue chromated

Threaded bushing

- Steel, zinc-plated, blue chromated

Body

- Rubber natural caoutchouc (NR), black

More information

Further products

- Support Legs, Impact cushioning

Drawing



picture 1

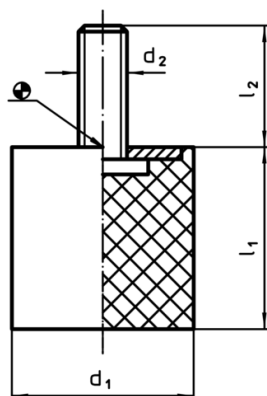

picture 2

Order information

Dimensions					Spring rate R ~ [N/mm]	Load capacity max. [N]	Spring range ~ [mm]	Temperature range		Weight [g]	Art. No.
d ₁	l ₁	d ₂	s	t				min.	max.		
[mm]								[°C]			
with female thread – picture 1, steel											
75	30	M12	3	9	600	4500	7.5	-30	80	210	25150.0376

Application example

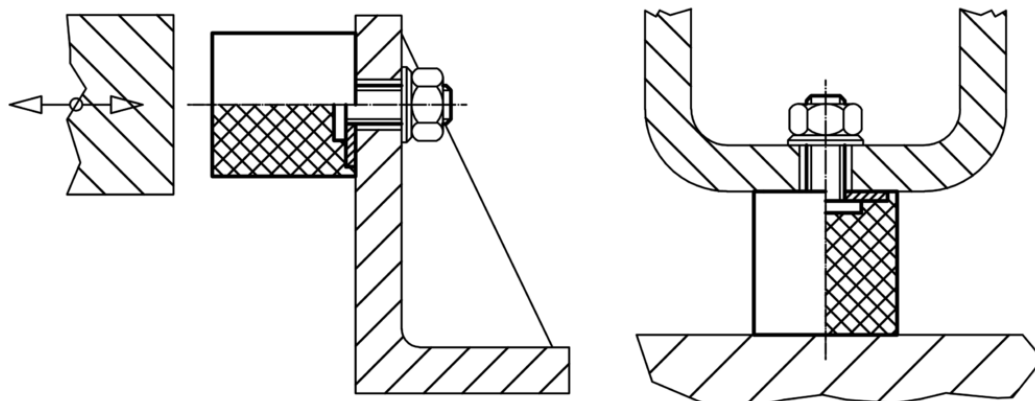

Compliance

RoHS compliant

Contains lead - compliant according to exceptions 6a / 6b / 6c

Contains SVHC substances >0,1% w/w

Contains lead - SVHC list [REACH] as of 10.06.2022

Contains Proposition 65 substances



Lead can cause cancer and reproductive harm from exposure
<https://www.P65Warnings.ca.gov/>

Free from Conflict Minerals

This product does not contain any substances designated as "conflict minerals" such as tantalum, tin, gold or tungsten from the Democratic Republic of Congo or adjacent countries.