

## Shims for thread-turning tool holder

For inserting into thread-turning tool holder no. 17745-17747

**ATORN**<sup>®</sup>

### Application

For inserting into thread-turning tool holder no. 17745-17747. Sets the thread-turning insert at the correct angle.

### Version

- Shims for thread-turning tool holder

### Advantage

- Precision-ground for a high degree of dimensional accuracy

### Delivery

Shim

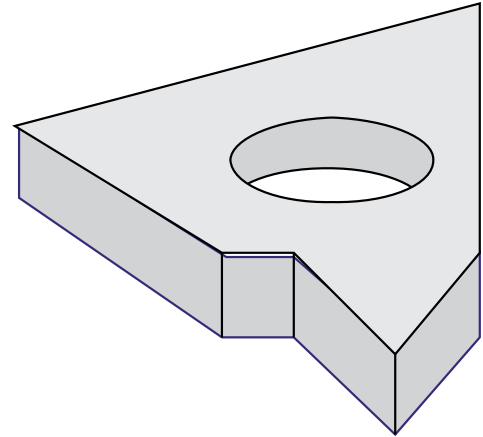

<b>Art. no.</b>	<b>17749 710</b>
<b>Base plate code</b>	AE 16 +3.5
<b>Resulting pitch angle</b>	+3.5°
<b>Suitable for indexable insert size</b>	16
<b>Suitable for holder</b>	ER/IL

### EAN-Code

4050293204322