

40x40x10 mm

5.4 CFM



■ Specifications

	Bearing	Rating Voltage	Power Current	Power Consumption	Speed	Air Flow	Static Pressure	Noise	Weight	Curve
	● VAPO	(VDC)	(mA)	(WATTS)	(RPM)	(CFM)	(inch-H ₂ O)	(dB(A))	(g)	
HA40101V4-1000U-A99	●	12	31	0.38	5000	5.4	0.09	15.7	15.4	1

■ Air Flow-Static Pressure Characteristics

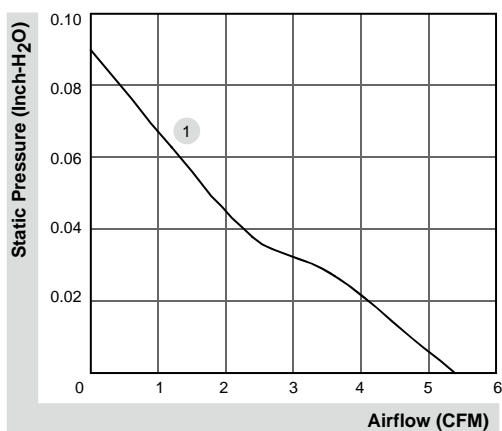

■ External dimensions(mm)

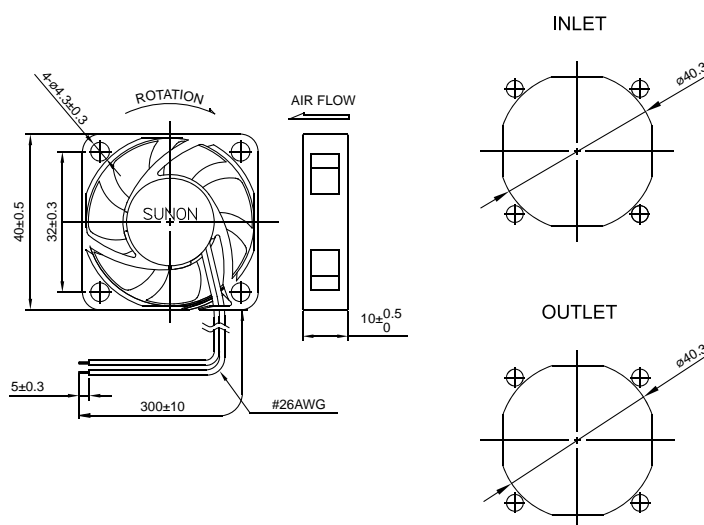

*All model could be customized. Please contact with Sunon Sales.

*Specifications are subject to change without notice. Please Visit SUNON website at www.sunon.com for update information.