

NEWSTAR

AV & IT MOUNTS



NS-CLMP40WHITE



Desk clamp set

Warning: Do not overtighten the clamp, because it can damage the screen.



Klemmsatz für Schreibtisch

Warnung: Ziehen Sie die Klemme nicht zu fest an, da dies den Bildschirm beschädigen kann.



Kit di morsetti da scrivania

Avvertimento: Non stringere eccessivamente il morsetto, poiché può danneggiare lo schermo.



Bureauklem set

Waarschuwing: Draai de klem niet te strak aan, dit zou het scherm kunnen beschadigen.



Ensemble de pinces de bureau

Attention: Ne serrez pas trop les pinces, car cela peut endommager l'écran.



Juego de abrazaderas de escritorio

¡Advertencia: No apriete demasiado la abrazadera, ya que puede dañar la pantalla.

NS-CLMP40WHITE

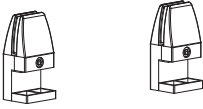

Parts



A (x2)



B (x4)



M6x16 (x6)
C



M6x30 (x2)
D



E (x4)



F (x1)

Step 1

1

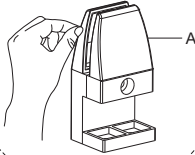

2

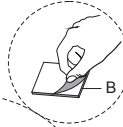
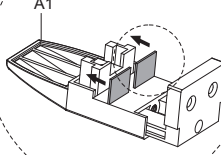

3

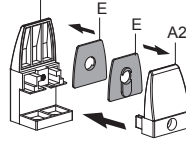

Step 2

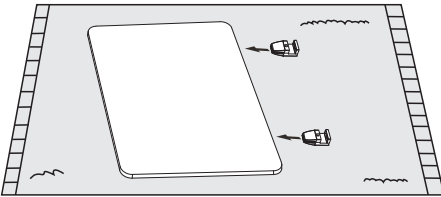

F

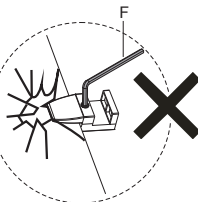
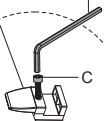

Do not overtighten the clamp, because it can damage the screen.

Step 3

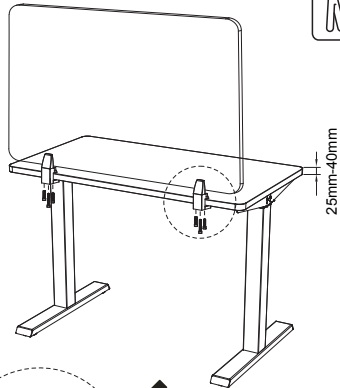

1

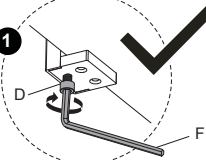

2

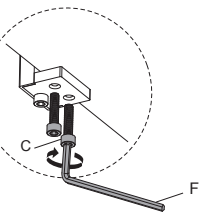

1

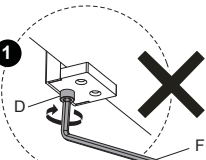

Do not overtighten screw D, because it can damage the clamp.