

Puck d=102mm

Accessories

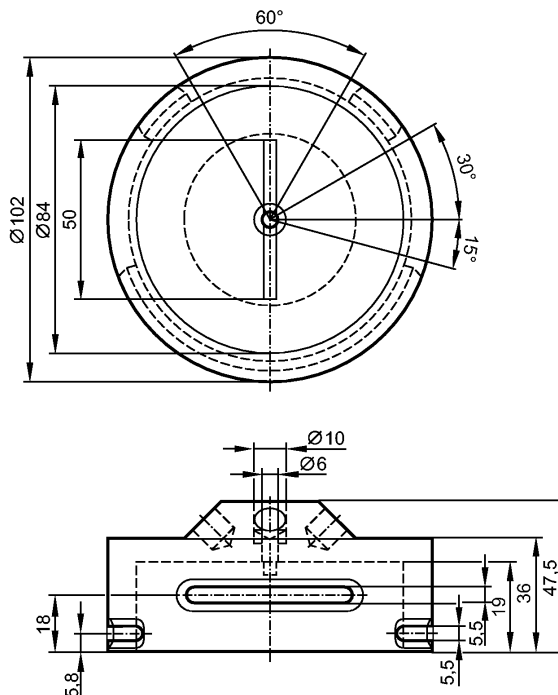

Product characteristics

Target puck

Ø 102 mm

adjustable target screws

Mechanical data

Design

for mechanical interfaces to ISO 5211 (DIN 3337) on
pneumatic actuators or manually-operated valves

Housing materials

Target puck: PVC; screws: stainless steel 316Ti / 1.4571

Weight [kg]

0.186

Remarks

Pack quantity [piece]

1

Other data

Shaft height [mm]

30

Hole spacing [mm]

130