



Model Number

V1-W-OR2M-POC

Female cordset, M12, 4-pin, TPE cable, welding-bead resistant

Features

- Resistant to welding bead formation
- Suitable for robotic applications / torsion resistant
- Does not give off silicone
- Ozone resistant
- Knurled nut suitable for tool assembly
- Immunity to vibration, with mechanical latching
- Gold-plated and machined contacts
- Protection degree IP67 / IP68 / IP69K

Dimensions

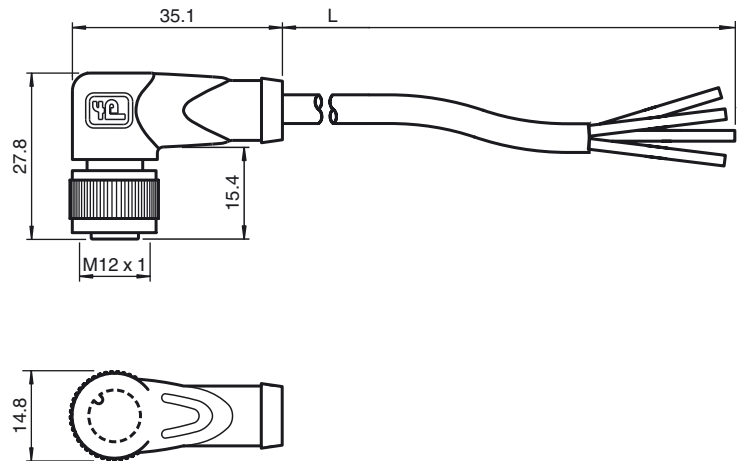

Technical data

General specifications

Number of pins	4
Connection 1	socket
Construction type 1	right angle
Threading 1	M12
Connection 2	cable end

Electrical specifications

Operating voltage	U_B	max. 250 V AC/DC
Test voltage		> 1500 V _{eff} AC
Operating current		max. 4 A
Volume resistance		< 5 mΩ

Ambient conditions

Ambient temperature	Body: -40 ... 90 °C (-40 ... 194 °F) Cable, flexing: -15 ... 120 °C (5 ... 248 °F) for 20000 h -15 ... 150 °C (5 ... 302 °F) for 3000 h cable, fixed: -40 ... 120 °C (-40 ... 248 °F) for 20000 h -40 ... 150 °C (-40 ... 302 °F) for 3000 h
Pollution Degree	3

Mechanical specifications

Contact elements	spring-loaded contact socket
Pin diameter	1 mm
Protection degree	IP67 / IP68 / IP69k
Material	
Contacts	CuSn / Au
Contact surface	Au
Body	TPU, green
Cable	TPE resistant to welding bead formation
Slotted nut	Diecast zinc
Core insulation	ETFE
Cable	fine-strand, flexible
Sheath diameter	Ø 4.8 mm
Bending radius	> 10 x cable diameter, moving
Color	orange
Cores	4 x 0.34 mm ²
Conductor construction	19 x 0.16 mm Ø
Length	L 2 m
Flammability	
Contact material	HB
Housing	V-2
Cable	flame-resistant

Compliance with standards and directives

Electrical connection

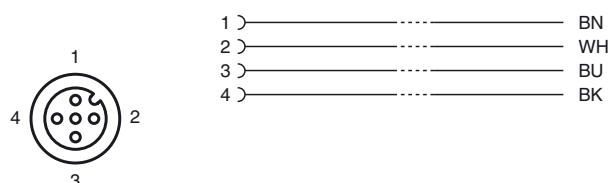



Standard conformity	
Protection degree	EN 60529:2000
Standards	IEC 61076-2-101:2008
Flammability	Body: UL 94 Line: UL 1581 Section 1061; IEC 60332-1-2:2004

Release date: 2013-08-14 13:19 Date of issue: 2013-08-14 233485_eng.xml