

# EVC107



## Connection cable

VDOAH032MSS0007H03STGH030MSS



Application		
Special feature		Free from silicone; Halogen-free; Gold-plated contacts; Drag chain suitability
Free from silicone		yes
Electrical data		
Operating voltage	[V]	10...36 DC
Protection class		II
Max. current load total	[A]	4
Outputs		
Electrical design		PNP
Operating conditions		
Ambient temperature	[°C]	-25...90
Note on ambient temperature		cULus: ...75
Ambient temperature (moving)	[°C]	-25...90
Note on ambient temperature (moving)		cULus: ...75
Protection		IP 65; IP 67; IP 68; IP 69K
Tests / approvals		
MTTF	[years]	20027

# EVC107



## Connection cable

VDOAH032MSS0007H03STGH030MSS

Mechanical data		
Weight [g]	238.2	
Dimensions [mm]	15.5 x 15.5 x 49.5	
Materials	connector housing: TPU orange; socket housing: TPU black transparent; Sealing: FKM	
Material nut	brass, nickel-plated / brass, nickel-plated	
Drag chain suitability	yes	
Drag chain suitability	bending radius for flexible use	min. 10 x cable diameter
	travel speed	max. 3.3 m/s for a horizontal travel length of 5 m and max. acceleration of 5 m/s <sup>2</sup>
	bending cycles	> 5 Mio.
	torsional strain	± 180 °/m

Displays / operating elements		
Display	switching status	1 x LED, yellow
	operation	1 x LED, green

Remarks	
Notes	Please see the technical note under "Downloads"
Pack quantity	1 pcs.

### Electrical connection - plug

Connector: 1 x M12, straight; Locking: brass, nickel-plated; Contacts: gold-plated; Tightening torque: 0.6...1.5 Nm



### Electrical connection

Cable: 7 m, PUR, Halogen-free, black, Ø 4.3 mm; 3 x 0.34 mm<sup>2</sup> (42 x Ø 0.1 mm)

### Connection

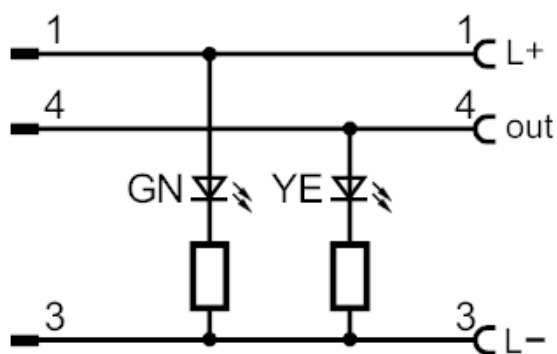

### Electrical connection - socket

Connector: 1 x M12, angled; Locking: brass, nickel-plated; Contacts: gold-plated; Tightening torque: 0.6...1.5 Nm

# EVC107



## Connection cable

VDOAH032MSS0007H03STGH030MSS

