

M12 male 0° / RJ45, 45° left, shielded, Ethernet

PUR 2x2xAWG22 shielded gn UL,CSA+dragchain 1,5m

Ethernet CAT 5, D-coded
 Male straight to male 45° left
 M12 - RJ45
 4-pole, shielded

Further cable lengths on request. Plastic housings with good resistance against chemicals and oils. The resistance to aggressive media should be individually tested for your application. Further details on request.

[Link to Product](#)

Illustration

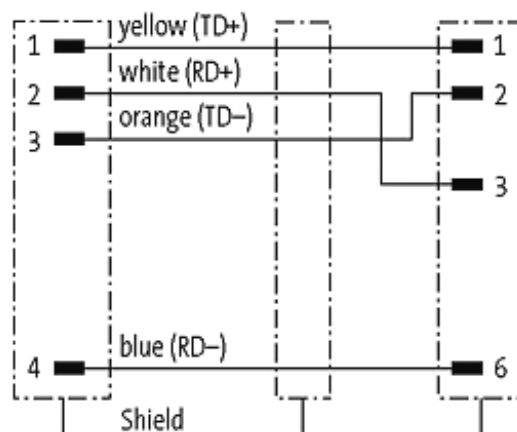
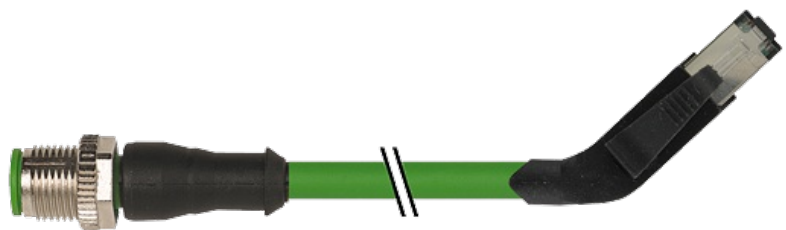

Male



Male

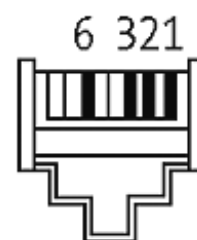

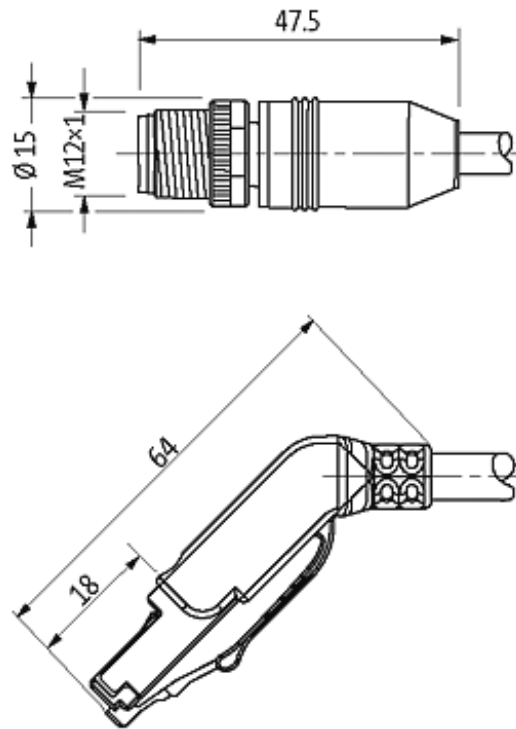

Product may differ from Image

Approvals



More Info



Form

44741

Technical Data

Operating voltage	60 V DC
Operating current per contact	max. 2 A
Transfer parameters	CAT5, class D (ISO/IEC 11801:2002), (EN 50173-1)
Transfer rate	10/100 Mbit/s full duplex
Protection	IP67 (M12) - IP20 (RJ45)
Locking of ports	Screw thread M12 × 1 mm (recommended torque 0.6 Nm) self-securing

Cables

Cable number	796
No./diameter of wires	2 × 2 × AWG22

Wire isolation	PE (wh, ye, bl, or)
C-track properties	2 Mio.
Jacket Color	green
Shore hardness outer jacket	90 ± 5A
Material (jacket)	PUR (UL/CSA)
Outer diameter	approx. 6.7 mm
Bend radius (fixed)	5 × outer Ø
Bend radius (moving)	15 × outer Ø
Temperature range (fixed)	-40...+80 °C
Temperature range (mobile)	-20...+60 °C
Shielded	yes

General data

Temperature range	-25...+70 °C
-------------------	--------------

Commercial data

country of origin	DE
customs tariff number	85444210
minimum order quantity	1