

TWTD Series — Full Size NEMA Pushbuttons

A4

Switches & Pilot Devices



TWTD Series: Heavy duty switches built to last

Key features include:

- Variety of button sizes up to 2 9/16" (65mm)
- Rugged construction includes chrome plated zinc locking ring die cast zinc mounting threads, screw mounted contact blocks
- LED or incandescent illumination
- Transformer or full voltage
- Transparent contact windows
- Slow make, double break self cleaning contacts
- Modular construction for maximum flexibility
- Double nickel plated terminal screws
- Available assembled or as sub-components
- NEMA 4x and IP65 watertight/oiltight panel
- Large M3.5 screw terminals with captive sems plate

The rugged series of TWTD switches offers both variety and durability in an attractive design.

With button sizes up to 2 9/16" (65mm), chrome plated zinc locking rings, die cast zinc mounting threads, steel anti-rotation rings, and self cleaning contacts, the TWTD's are here to stay.

The TWTD series also offers either LED or incandescent illumination in full voltage and transformer models.

Transparent contact windows allow the viewing of IDEC's self cleaning slow-make/slow-break contacts.

Regardless of your switching needs, the TWTD series provides the kind of long lasting, industrial strength quality you've come to expect from IDEC.



UL Listed
File No. E70646







SA® File No. LR48366



D Ref. No. 117617MC



Certificate No.
2005010305145658

Specifications	Conforming to Standards	EN60947-1, EN60947-5-1, VDE0660-200, UL508, CSA C22-2 No.14
	Approvals	  UL Listed File No. E70646 File No. LR48366   Ref. No. 117617MC
	Operating Temperature	Operation: -25 to +50°C (without freezing) Storage: -40 to +70°C (without freezing)
	Vibration Resistance	10 to 55Hz, 98m/sec ² (10g) conforming to IEC6068-2-6
	Shock Resistance	980m/sec ² (100g) conforming to IEC6068-2-7
	Electric Shock Protection	Class 0 conforming to IEC60536
	Degree of Protection	IP65 (from front of the panel) (conforming to IEC60529) IP54 (key switches) NEMA 1, 2, 3, 3R, 3S, 4, 4X, 5, 12, 13 (conforming to NEMA ICS6-110)
	Mechanical Life	Momentary pushbuttons: 5,000,000 (900 operations per hour) All other switches: 500,000
	Pollution Degree (conforming to IEC60947-1)	3 for switches not using a transformer 2 for switches using a transformer
	Mechanical-Electrical Specifications	Rated Operational Characteristics
Rated Insulation Voltage		600V
Rated Switching Over-Voltage		Less than 4kV, conforming to IEC60947-1
Rated Impulse Withstanding Voltage		4kV for contact circuit 2.5kV for lamp circuit
Rated Thermal Current		10 Amp
Minimum Switching Capacity		5 mA at 3V AC/DC
Contact Operation		Slow break NC or NO, self-cleaning
Operating Force		Flush and extended pushbuttons—with 1NO or 1NC contact: 6.2±2N (momentary), 7.0±2N (maintained) Additional contacts—1NO or 1NC: +3.2N (momentary), + 3.3N (maintained)
Terminal Referencing		Conforming to CENELEC EN50005
Recommended Terminal Torque		0.8 N m (7.1 in lb.)
External Short-Circuit Protection		10A 250V fuse conforming to IEC60269-1
Applicable Wire Size		Minimum 1 x 22 AWG, max. 2 x 14 AWG or 1 x 12 AWG
Contact Resistance		Initial contact resistance of 50mΩ or less
Contact Gap		4mm (NO and NC) 2mm (NO-EM and NC-LB)
Lamp Ratings		Incandescent: 1 W LEDs: 6, 12, 24V: 20mA / 120, 240V: 10mA
Maximum Inrush Current		40 A (40 msec)
Contact Material	Silver	

Contact Ratings	Contact Ratings by Utilization Category IEC 60947-5-1		AC-15 (A600) DC-13 (P600)						
	Contact Ratings by Utilization Category								
	Operational Voltage			24V	48V	50V	110V	220V	440V
	Operation Current	AC 50/60 Hz	AC-12 Control of resistive loads & solid state loads	10A	—	10A	10A	6A	2A
			AC-15 Control of electromagnetic loads (> 72VA)	10A	—	7A	5A	3A	1A
DC	DC	DC-12 Control of resistive loads & solid state loads	8A	5A	—	2.2A	1.1A	—	
		DC-13 Control of electromagnets	5A	2A	—	1.1A	0.6A	—	

Non-Illuminated Pushbuttons (Assembled)

A4

Switches & Pilot Devices



Assembled Pushbuttons

A B () D 1 10 N - B

<p>Function _____</p> <p>B: Momentary O: Maintained V: Pushlock Turn Reset Y: Push-Pull</p> <p>Bezel Shape _____</p> <p>Blank: Octagonal F: Full Shroud G: Mushroom Shroud P: Neoprene Boot</p> <p>Series Designation _____</p> <p>D: TWTD Series</p>	<p>Button Color</p> <p>B: Black G: Green R: Red S: Blue W: White Y: Yellow</p> <p>Contact Arrangement</p> <p>10: 1NO 01: 1NC 20: 2NO 02: 2NC 11: 1NO-1NC 22: 2NO-2NC</p> <p>Button Shape</p> <p>1: Flush 2: Extended 3: Mushroom Ø 40mm 4: Jumbo Mushroom Ø 65mm</p>
--	--



1. Use only when interpreting part numbers. Do not use for developing part numbers.
2. Custom contact configurations available, contact IDEC for details.

Non-Illuminated Pushbuttons (Assembled) con't

Part Numbers: Non-Illuminated Pushbuttons

Style	Contacts	Part Number	
		Momentary	Maintained
Flush	1NO 1NC 1NO-1NC 2NO 2NC	ABD110N-① ABD101N-① ABD111N-① ABD120N-① ABD102N-①	AOD110N-① AOD101N-① AOD111N-① AOD120N-① AOD102N-①
Extended	1NO 1NC 1NO-1NC 2NO 2NC	ABD210N-① ABD201N-① ABD211N-① ABD220N-① ABD202N-①	AOD210N-① AOD201N-① AOD211N-① AOD220N-① AOD202N-①
Extended with Neoprene Boot	1NO 1NC 1NO-1NC 2NO 2NC	ABPD210N-① ABPD201N-① ABPD211N-① ABPD220N-① ABPD202N-①	AOPD210N-① AOPD201N-① AOPD211N-① AOPD220N-① AOPD202N-①
Recessed	1NO 1NC 1NO-1NC 2NO 2NC	ABFD110N-① ABFD101N-① ABFD111N-① ABFD120N-① ABFD102N-①	AOFD110N-① AOFD101N-① AOFD111N-① AOFD120N-① AOFD102N-①
Extended with Full Shroud	1NO 1NC 1NO-1NC 2NO 2NC	ABFD210N-① ABFD201N-① ABFD211N-① ABFD220N-① ABFD202N-①	AOFD210N-① AOFD201N-① AOFD211N-① AOFD220N-① AOFD202N-①
Ø 40mm Mushroom Head	1NO 1NC 1NO-1NC 2NO 2NC	ABD310N-① ABD301N-① ABD311N-① ABD320N-① ABD302N-①	AOD310N-① AOD301N-① AOD311N-① AOD320N-① AOD302N-①
Ø 40mm Mushroom Head with Full Shroud	1NO 1NC 1NO-1NC 2NO 2NC	ABGD310N-① ABGD301N-① ABGD311N-① ABGD320N-① ABGD302N-①	AOGD310N-① AOGD301N-① AOGD311N-① AOGD320N-① AOGD302N-①
Ø 65mm Jumbo Mushroom Head	1NO 1NC 1NO-1NC 2NO 2NC	ABD410N-① ABD401N-① ABD411N-① ABD420N-① ABD402N-①	AOD410N-① AOD401N-① AOD411N-① AOD420N-① AOD402N-①
Ø 65mm Jumbo Mushroom Head with Shallow Shroud	1NO 1NC 1NO-1NC 2NO 2NC	ABGD410N-① ABGD401N-① ABGD411N-① ABGD420N-① ABGD402N-①	AOGD410N-① AOGD401N-① AOGD411N-① AOGD420N-① AOGD402N-①
Ø 65mm Jumbo Mushroom Head With Deep Shroud	1NO 1NC 1NO-1NC 2NO 2NC	ABFD410N-① ABFD401N-① ABFD411N-① ABFD420N-① ABFD402N-①	AOFD410N-① AOFD401N-① AOFD411N-① AOFD420N-① AOFD402N-①



1. In place of ①, specify the Button Color Code.
2. For sub-assembly part numbers, see next page.
3. For accessories, see page A4-188.
4. † Neoprene boot available only in Black (B), Green (G), Red (R) and Yellow (Y).

① Button Color Code

Color	Code
Black	B
Green	G
Red	R
Blue	S
White	W
Yellow	Y



1. 65mm Jumbo mushroom not available in white.
2. Neoprene boot is not available in blue or white.







Non-Illuminated Pushbuttons (Sub-Assembled)

A4





Switches & Pilot Devices



Part Numbers: Operators

Style	Part Number	
	Momentary	Maintained
Flush/Extended 	ABD-100	AOD-100
Extended with Full Shroud 	ABFD-200	AOFD-200
Ø 40mm Mushroom/ Ø 65mm Jumbo Mushroom 	ABD-300	AOD-300
Ø 40mm Mushroom with Full Shroud 	ABGD-300	AOGD-300
Ø 65mm Jumbo Mushroom with Shallow Shroud 	ABGD-400	AOGD-400
Ø 65mm Jumbo Mushroom with Deep Shroud 	ABFD-400	AOFD-400

Part Numbers: Buttons and Lenses

Style	Part Number
Flush 	ABD1BN-①
Extended 	ABD2BN-①
Ø 40mm Mushroom 	ABD3BN-①
Ø 65mm Jumbo Mushroom 	ABD4BN-①



In place of ①, specify the Button Color Code. (See table previous page)

Part Numbers: Contact Blocks

Description	Part Number	
	1NO	1NC
	BST-010 BST-010S (early make)	BST-001 BST-001S (late break)
Dummy Block	BST-D	



- Dummy blocks (no contacts) are used with an odd number of contact blocks.
- Combining BST-010S and BST-001S result in overlapping contacts.

E-Stops (Assembled)



A4

Switches & Pilot Devices

Assembled E-Stops

A V (L) D 3 (99) 11 (D) N - R - (24V)

Function

V: Pushlock Turn Reset
Y: Push-Pull

Illumination

Blank: None
L: Illuminated

Series Designation

D: TWTD Series

Button/Lens Size

3: 40mm Mushroom

Illuminated Circuit (illuminated unit only)

99: Full Voltage (lamp determines voltage)
126: 120V AC Step Down Transformer
246: 240V AC Step Down Transformer
486: 480V AC Step Down Transformer

Lamp Voltage

(full voltage illuminated units only)

6V: 6V AC/DC
12V: 12V AC/DC
24V: 24V AC/DC
120V: 120V AC/DC
240V: 240V AC/DC

Button/Lens Color

A: Amber R: Red W: White
G: Green S: Blue Y: Yellow

Lamp Type (illuminated units only)

Blank: Incandescent
D: LED

Contact Arrangement





10: 1NO 01: 1NC
20: 2NO 02: 2NC
11: 1NO/1NC 22: 2NO/2NC



1. Use only when interpreting part numbers. Do not use for developing part numbers.
2. Custom contact configurations available, contact IDEC for details.

E-Stops (Assembled)

Part Numbers: E-Stop Switches

Style	Contacts	Part Number
A4 Ø 40mm Pushlock Turn Reset 	1NO 1NC 1NO-1NC 2NO 2NC	AVD310N-R* AVD301N-R* AVD311N-R* AVD320N-R* AVD302N-R*
Ø 40mm Illuminated Pushlock Turn Reset 	1NO-1NC 2NO 2NC	AVLD39911⑤N-R-③* AVLD39920⑤N-R-③* AVLD39902⑤N-R-③*
Ø 40mm Push-Pull 	1NO 1NC 1NO-1NC 2NO 2NC	AYD310N-① AYD301N-① AYD311N-① AYD320N-① AYD302N-①
Ø 40mm Push-Pull 	1NO-1NC 2NO 2NC	AYLD39911⑤N-②-③** AYLD39920⑤N-②-③** AYLD39902⑤N-②-③**
Ø 40mm Momentary Push-Pull (3-position) 	1NO-1NC 1NC-1LB†	AYLD229911⑤N-②-③-TK962 AYLD229902S⑤N-②-③-TK962
	1NO-1NC 1NC-1LB†	AYLD22 ④ 11⑤N-②-TK962 AYLD22 ④ 02S⑤N-②-TK962

3 Position Push-Pull

Contact	Push	Center	Pull
NC (BST-001)	0	0	X
NC-LB (BST-001S)	0	X	X
NO (BST-010)	X	0	0
NO-EM (BST-010S)	X	X	0



- In place of ①, specify the button color code.
- In place of ②, specify the lens color code.
- In place of ③, specify the Full Voltage (lamp voltage) Code.
- In place of ④, specify the transformer voltage code.
- In place of ⑤, specify the Lamp Type code.
- *Available in red only.
- 3 position push-pull available in spring return to center only.
- † The most common configuration for motor starting applications.
- For accessories, see page A4-188.
- For dimensions, see page A4-192.

① Button Color Code

Color	Code
Black	B
Green	G
Red	R
Blue	S
Yellow	Y

② LED Color Codes

Color	Code
Amber	A
Green	G
Red	R
Blue	S
White	W

③ Full Voltage Code

Voltage	Code
6V AC/DC	6V
12V AC/DC	12V
24V AC/DC	24V
120V AC	120V
240V AC	240V (LED only)

④ Transformer Voltage Codes

Voltage	Code
120VAC	126
240VAC	246
480VAC	486



Transformers step down to 6V.

⑤ Lamp Type Code

Lamp	Code
Incandescent	Blank
LED	D

Part Numbers: Unibody E-Stops

Style	Contacts	Part Number
Ø 40mm Pushlock Turn Reset (available in Red only) 	1NO-1NC 2NC	HN1E-BV4F11-R* HN1E-BV4F02-R*
Illuminated Ø 40mm Pushlock Turn Reset (available in Red only) 	1NO-1NC 2NC	HN1E-LV4F11Q⑤-R-③ HN1E-LV4F02Q⑤-R-③



- * Available in Red only.
- **Not available in blue.
- In place of ③, specify Full Voltage Code.
- With single unit construction, the positive action contacts are integrated in the body of the switch. This provides an extra degree of safety and reliability for critical emergency stop functions.
- For nameplates and accessories, see page A3-96.
- For dimensions, see page A3-100.
- For sub-assembly part numbers, see next page.
- HN1E series E-stops comply with EN418, the IEC "E-Stop Addendum to the Low Voltage Directive," this includes "tamper proof" operation whereby a change of contact state is not possible by "teasing" or "floating" the operator.

E-Stops (Sub-Assembled)

Transformer* + Operator + Lamp + Button/Lens = Complete Part



*Not required for full voltage units (full voltage clips used instead).

Part Numbers: Operators

	Style	Part Number
Ø 40mm Pushlock Turn Reset		AVD-300
Illuminated Ø 40mm Pushlock Turn Reset		AVLD3-0600N
Ø 40mm Push-Pull		AYD-3100
Illuminated Ø 40mm Push-Pull		2 pos AYLD-0600
		3 pos AYLD22TK962-0B01

Part Numbers: Buttons and Lenses

	Style	Part No.
Button for Pushlock Turn Reset E-Stop (Ø 40mm, red only)		AVN3B-R
Lens for Illuminated Pushlock Turn Reset E-Stop (Ø 40mm, red only)		AVLN3LU-R
Button for Push-Pull E-Stop (Ø 40mm)		AYD3BN-①
Lens for Illuminated Push-Pull E-Stop (Ø 40mm)		2 pos* AYLD3L-②
		3 pos AYLD2L-②

- In place of ①, specify the Button Color Code. (See table below)
- In place of ②, specify the LED Color Code.
- *Not available in blue.

Part Numbers: Lamps

Type	Voltage	Part Number
LED	6V AC/DC	LSTD-6②
	12V AC/DC	LSTD-1②
	24V AC/DC	LSTD-2②
	120V AC	LSTD-H2②
	240V AC	LSTD-M4②
Incandescent	6V AC/DC	IS-6
	12V AC/DC	IS-12
	24V AC/DC	IS-24
	120VAC	L-120L



- In place of ②, specify the LED color code.
- The LED contains a current-limiting resistor and a protection diode.

① Button Color Code

Color	Code
Black	B
Green	G
Red	R
Blue	S
Yellow	Y

② LED Color Codes

Color	Code
Amber	A
Green	G
Red	R
Blue	S
White	W

Part Numbers: Contact Blocks

Description	Part Number	
All Control Units	1N0	1NC
	BST-010	BST-001
	BST-010S (early make)	BST-001S (late break)
Dummy Blocks	BST-D	



- Dummy blocks (no contacts) are used with an odd number of contact blocks.
- Combining BST-010S and BST-001S result in overlapping contacts (remain on, or closed, when switch is moved between two positions).

Part Numbers: Full Voltage Clips

Primary Voltage (50/60Hz)	Part Number
Full Voltage Clips (2 req'd for each unit)	APD-F

Part Numbers: Transformers

Description	Primary Voltage (50/60Hz)	Part Number
	120V AC	TWD-0126
	240V AC	TWD-0246
	480V AC	TWD-0486



6V secondary voltage (uses 6V lamp).

A4

Switches & Pilot Devices

Pilot Lights (Assembled)

A4

Switches & Pilot Devices



Assembled Pilot Lights

A P D 1 126 D N - R - ()

<p>Function P: Pilot Light</p> <p>Series Designation D: TWTD Series</p> <p>Lens Shape 1: Dome</p> <p>Rated Operational Voltage (Primary) Transformer Type Full Voltage Type 126:120V AC 99:Full Voltage 246:240V AC 486:480V AC</p>	<p>Lamp Voltage (Full Voltage Only) 6V: 6V AC/DC 12V:12V AC/DC 24V:24V AC/DC 120V:120V AC 240V: 240V AC (LED only)</p> <p>Lens Color Code A: Amber G: Green R: Red S: Blue W: White Y: Yellow</p> <p>Lamp Type Blank: Incandescent Lamp D: LED Lamp</p>
---	--

Use only when interpreting part numbers. Do not use for developing part numbers.

Part Numbers: LED and Incandescent Pilot Lights

Style	Operating Voltage	Part Number	
		LED	Incandescent
 Transformer Dome	120V AC 240V AC 480V AC	APD1126DN-② APD1246DN-② APD1486DN-②	APD1126N-② APD1246N-② APD1486N-②
 Full Voltage Dome	—	APD199DN-②-③	APD199N-②-③

② Lens Color Code

Color	Code
Amber	A
Green	G
Red	R
Blue	S
White	W
Yellow	Y

③ Full Voltage Code

Voltage	Code
6V AC/DC	6V
12V AC/DC	12V
24V AC/DC	24V
120V AC	120V
240V AC (LED only)	240V

1. In place of ②, specify the Lens/LED Color Code.
2. In place of ③, specify the Full Voltage Code (lamp voltage).



Pilot Lights (Sub-Assembled)

Transformer* + Operator + Lamp + Lens = Complete Part



Note: Not required for full voltage units (full voltage clips used instead).

Part Numbers: Operators

Style	Part Number
Full Voltage 	APD-199
AC Adaptor/Transformer 	APD-006



 The lens, lamp, and transformer/adaptor or the full voltage clips must be ordered separately.

Part Numbers: Lenses

Style	Part Number
Dome Lens 	APN106L-②

 1. In place of ②, specify the Lens Color Code.
2. LED and incandescent lenses differ in shade only. Some colors have only one shade.

Part Numbers: Lamps

Type	Voltage	Part Number
LED 	6V AC/DC	LSTD-6②
	12V AC/DC	LSTD-1②
	24V AC/DC	LSTD-2②
	120V AC	LSTD-H2②
	240V AC	LSTD-M4②
Incandescent 	6.3V AC/DC	IS-6
	12V AC/DC	IS-12
	24V AC/DC	IS-24
	120VAC, 1-8W	L-120L

 1. In place of ②, specify the LED color code.
2. The LED contains a current-limiting resistor and a protection diode.

Part Numbers: Full Voltage Clips

Primary Voltage (50/60Hz)	Part Number
	APD-F

 Required for all full voltage models. Two pieces each.

Part Numbers: Transformers

Description	Primary Voltage (50/60Hz)	Part Number
Transformers 	120V AC	TWD-0126
	240V AC	TWD-0246
	480V AC	TWD-0486

 6V secondary voltage (use 6V lamp).

② Lens/LED Color Code

Color	Code
Amber	A
Green	G
Red	R
Blue	S
White	W
Yellow	Y

A4

Switches & Pilot Devices

Illuminated Pushbuttons (Assembled)



A4

Switches & Pilot Devices

Assembled Illuminated Pushbuttons

A L () D 2 126 11 (D) N - R - ()



<p>Function _____</p> <p>L: Momentary Action OL: Alternate Action</p> <p>Bezel Shape _____</p> <p>Blank: Octagonal F: Full Shroud</p> <p>Series Designation _____</p> <p>D: TWTD Series</p> <p>Lens Shape _____</p> <p>2: Extended 3: Mushroom Ø 40mm</p> <p>Rated Operational Voltage (Primary) _____</p> <p>Transformer 126:120V AC 246:240V AC 486:480V AC</p>	<p>Full Voltage Type 99:Full Voltage</p>	<p>Lamp Voltage (Full Voltage Only)</p> <p>6V: 6V AC/DC 12V: 12V AC/DC 24V: 24V AC/DC 120V:120V AC 240V: 240V AC (LED only)</p> <p>Lens Color Code</p> <p>A: Amber G: Green R: Red S: Blue W: White Y: Yellow</p> <p>Lamp Type</p> <p>Blank: Incandescent Lamp D: LED</p> <p>Contact Arrangement</p> <p>20: 2NO 02: 2NC 11: 1NO-1NC</p>
--	--	---



1. Use only when interpreting part numbers. Do not use for developing part numbers.
2. All transformers and AC Adaptors step down to 6V.

Illuminated Pushbuttons (Assembled) con't

Part numbers: Illuminated Pushbuttons

Style		Contacts	Part Number	
			Momentary	Maintained
Extended Lens 	Full Voltage	1NO-1NC 2NO 2NC	ALD29911⑤N-②-③ ALD29920⑤N-②-③ ALD29902⑤N-②-③	AOLD29911⑤N-②-③ AOLD29920⑤N-②-③ AOLD29902⑤N-②-③
	Transformer	1NO-1NC 2NO 2NC	ALD2 ④ 11⑤N-② ALD2 ④ 20⑤N-② ALD2 ④ 02⑤N-②	AOLD2 ④ 11⑤N-② AOLD2 ④ 20⑤N-② AOLD2 ④ 02⑤N-②
Extended Lens with Full Shroud 	Full Voltage	1NO-1NC 2NO 2NC	ALFD29911⑤N-②-③ ALFD29920⑤N-②-③ ALFD29902⑤N-②-③	AOLFD29911⑤N-②-③ AOLFD29920⑤N-②-③ AOLFD29902⑤N-②-③
	Transformer	1NO-1NC 2NO 2NC	ALFD2 ④ 11⑤N-② ALFD2 ④ 20⑤N-② ALFD2 ④ 02⑤N-②	AOLFD2 ④ 11⑤N-② AOLFD2 ④ 20⑤N-② AOLFD2 ④ 02⑤N-②
Ø 40mm Mushroom Lens 	Full Voltage	1NO-1NC 2NO 2NC	ALD39911⑤N-②-③ ALD39920⑤N-②-③ ALD39902⑤N-②-③	AOLD39911⑤N-②-③ AOLD39920⑤N-②-③ AOLD39902⑤N-②-③
	Transformer	1NO-1NC 2NO 2NC	ALD3 ④ 11⑤N-② ALD3 ④ 20⑤N-② ALD3 ④ 02⑤N-②	AOLD3 ④ 11⑤N-② AOLD3 ④ 20⑤N-② AOLD3 ④ 02⑤N-②



1. In place of ②, specify the Lens Color Code.
2. In place of ③, specify the Full Voltage Code (lamp voltage).
3. In place of ④, specify the Transformer Voltage Code.
4. In place of ⑤, specify the Lamp Type Code.

② Lens Color Codes

Color	Code
Amber	A
Green	G
Red	R
Blue	S
White	W
Yellow	Y

③ Full Voltage Codes

Voltage	Code
6V AC/DC	6V
12V AC/DC	12V
24V AC/DC	24V
120V AC	120V
240V AC (LED only)	240V

④ Transformer Voltage Codes

Voltage	Code
120VAC	126
240VAC	246
480VAC	486



6V secondary voltage
(uses 6V lamp).

⑤ Lamp Type Code

Lamp	Code
Incandescent	Blank
LED	D

Illuminated Pushbuttons (Sub-Assembled)

Transformer* + Contact Block + Operator + Lamp + Lens = Complete Part

A4

Switches & Pilot Devices



* Not required for full voltage types (full voltage types use APD-F full voltage clips).

Part Numbers: Operators

Style	Part Number	
	Momentary	Maintained
Extended 	ALD-0600	AOLD-0600
Extended with Full Shroud 	ALFD-0600	AOLFD-0600
40mm Mushroom 	ALD-0600	AOLD-0600

Part Numbers: Lamps

Type	Voltage	Part Number
LED 	6V AC/DC	LSTD-6 ^②
	12V AC/DC	LSTD-1 ^②
	24V AC/DC	LSTD-2 ^②
	120V AC	LSTD-H2 ^②
	240V AC	LSTD-M4 ^②
Incandescent 	6V AC/DC	IS-6
	12V AC/DC	IS-12
	24V AC/DC	IS-24
	120VAC	L-120L

② Lens/LED Color Codes

Color	Code
Amber	A
Green	G
Red	R
Blue	S
White	W
Yellow	Y

Mushroom lens not available in yellow.

1. In place of ②, specify the LED Color code.
2. The LED contains a current-limiting resistor and a protection diode.

Part Numbers: Lenses

Style	Part No.
Extended 	ALN06LU- ^②
Ø 40mm Mushroom 	ALN3LU- ^②

1. In place of ②, specify the Lens Color Code.
2. LED and incandescent lenses differ in shade only. Some colors have only one shade.

Part Numbers: Contact Blocks

Description	Part Number	
	1N0	1NC
All Control Units 	BST-010 BST-010S (early make)	BST-001 BST-001S (late break)
Dummy Blocks	BST-D	

1. Dummy blocks (no contacts) are used with an odd number of contact blocks.
2. Combining BST-010S and BST-001S result in overlapping contacts (remain on, or closed, when switch is moved between two positions).

Part Numbers: Full Voltage Clips

Primary Voltage (50/60Hz)	Part Number
Full Voltage Clips (2 req'd for each unit) 	APD-F

Required for all full voltage models.

Part Numbers: Transformers

Description	Primary Voltage (50/60Hz)	Part Number
Transformers 	120V AC	TWD-0126
	240V AC	TWD-0246
	480V AC	TWD-0486

6V secondary voltage (uses 6V lamp).

Non-Illuminated Selector Switches (Assembled)



**Knob Selector
(Non-illuminated)**



**Key Selector
(Non-illuminated)**



**Lever Selector
(Non-illuminated)**

A4

Switches & Pilot Devices

Assembled Selector Switches
A S D 2 () () 11 N - ()

<p>Function _____</p> <p>S: Selector Switch</p> <p>Series Designation _____</p> <p>D: TWTD Series</p> <p>Number of Positions _____</p> <p>2: 2-Position 3: 3-Position</p> <p>Spring Return Action _____</p> <p>Blank: Maintained 1: Spring return from Right 2: Spring return from Left 3: 2-Way spring return from Left and Right</p>	<p>Circuit Number _____</p> <p>(See Circuit # column of Selector Switch Contact Arrangement Chart on beginning on A4-185.)</p> <p>Contact Arrangement Code</p> <p>10: 1NO 01: 1NC 20: 2NO 02: 2NC 40: 4NO 04: 4NC 11: 1NO-1NC 22: 2NO-2NC</p> <p>Operator Style Code</p> <p>Blank: Knob Operator L: Lever Operator K: Key Operator</p>
--	---

Use only when interpreting part numbers. Do not use for developing part numbers.

Non-Illuminated Selector Switches (Assembled) con't

Part numbers: Non-Illuminated 2-Position Selector Switches

Style	Contact	Mounting	Operator Position			Part Number	Part Number	Part Number
			L	R		Maintained	Spring Return from Right	Spring Return from Left
1NO 2	1 2	0 0	X 0	Knob Lever Key	ASD210N ASD2L10N ASD2K10N	ASD2110N ASD21L10N ASD21K10N	ASD2210N ASD22L10N ASD22K10N	
1NC 2	1 2	X 0	0 0	Knob Lever Key	ASD201N-116 ASD2L01N-116 ASD2K01N-116	ASD2101N-116 ASD21L01N-116 ASD21K01N-116	ASD2201N-116 ASD22L01N-116 ASD22K01N-116	
1NO 1NC	1 2	0 X	X 0	Knob Lever Key	ASD211N ASD2L11N ASD2K11N	ASD2111N ASD21L11N ASD21K11N	ASD2211N ASD22L11N ASD22K11N	
2NO 2NC	1 2	0 0	X X	Knob Lever Key	ASD220N ASD2L20N ASD2K20N	ASD2120N ASD21L20N ASD21K20N	ASD2220N ASD22L20N ASD22K20N	
2NC 2NC	1 2	X X	0 0	Knob Lever Key	ASD202N-104 ASD2L02N-104 ASD2K02N-104	ASD2102N-104 ASD21L02N-104 ASD21K02N-104	ASD2202N-104 ASD22L02N-104 ASD22K02N-104	
2NO 2NC	1 2 3 4	0 X 0 X	X 0 X 0	Knob Lever Key	ASD222N ASD2L22N ASD2K22N	ASD2122N ASD21L22N ASD21K22N	ASD2222N ASD22L22N ASD22K22N	
2NO 2NC	1 2 3 4	0 0 X X	X X 0 0	Knob Lever Key	ASD222N-111 ASD2L22N-111 ASD2K22N-111	ASD2122N-111 ASD21L22N-111 ASD21K22N-111	ASD2222N-111 ASD22L22N-111 ASD22K22N-111	

Part Numbers: Non-Illuminated 3-Position Selector Switches

Style	Contact	Mounting	Operator Position				Part Number	Part Number	Part Number	Part Number
			L	C	R		Maintained	Spring Return from Right	Spring Return From Left	Spring Return Two-Way
2NO 2NC	1 2	X 0	0 0	0 X	Knob Lever Key	ASD320N ASD3L20N ASD3K20N	ASD3120N ASD31L20N ASD31K20N	ASD3220N ASD32L20N ASD32K20N	ASD3320N ASD33L20N ASD33K20N	
2NC 2NC	1 2	0 X	X X	X 0	Knob Lever Key	ASD302N ASD3L02N ASD3K02N	ASD3102N ASD31L02N ASD31K02N	ASD3202N ASD32L02N ASD32K02N	ASD3302N ASD33L02N ASD33K02N	
2NO 2NC	1 2 3 4	X 0 0 X	0 0 X X	0 X X 0	Knob Lever Key	ASD322N ASD3L22N ASD3K22N	ASD3122N ASD31L22N ASD31K22N	ASD3222N ASD32L22N ASD32K22N	ASD3322N ASD33L22N ASD33K22N	
2NO 2NC	1 2 3 4	X X 0 0	0 X X 0	X 0 0 X	Knob Lever Key	ASD322N-309 ASD3L22N-309 ASD3K22N-309	ASD3122N-309 ASD31L22N-309 ASD31K22N-309	ASD3222N-309 ASD32L22N-309 ASD32K22N-309	ASD3322N-309 ASD33L22N-309 ASD33K22N-309	
2NO 2NC	1 2 3 4	0 0 0 0	X X X 0	0 X 0 X	Knob Lever Key	ASD322N-310 ASD3L22N-310 ASD3K22N-310	ASD3122N-310 ASD31L22N-310 ASD31K22N-310	ASD3222N-310 ASD32L22N-310 ASD32K22N-310	ASD3322N-310 ASD33L22N-310 ASD33K22N-310	
4NO 4NC	1 2 3 4	X 0 X 0	0 0 0 0	0 X 0 X	Knob Lever Key	ASD340N ASD3L40N ASD3K40N	ASD3140N ASD31L40N ASD31K40N	ASD3240N ASD32L40N ASD32K40N	ASD3340N ASD33L40N ASD33K40N	
4NC 4NC	1 2 3 4	0 X 0 X	X X X X	0 0 X 0	Knob Lever Key	ASD304N ASD3L04N ASD3K04N	ASD3104N ASD31L04N ASD31K04N	ASD3204N ASD32L04N ASD32K04N	ASD3304N ASD33L04N ASD33K04N	



1. The truth table indicates the operating position of contact block when the operator is switched to that position.

X = On (closed contacts) O = Off (open contacts)

X-X = Overlapping Contacts: Remain on (closed contacts) when switch is moved between these two positions.

2. All knob and lever selector switches come in black. Other colors are available by ordering the knob or lever separately.

3. Custom contact arrangements available, see page A4-185 or call IDEC for details.

Switches & Pilot Devices

A4



Non-Illuminated Selector Switches (Sub-Assembled)

Contact Blocks + Operator + Knob or Lever* + Color Insert* = Complete Part †



- 1. * Not needed with key type switches.
- 2. † Knob type shown.

Part Numbers: Operators

Appearance/ Position	Description	Part Number
	2 Maintained	ASD200
	2 Spring-Ret. from Right	ASD2100
	2 Spring-Ret. from Left	ASD2200
	3 Maintained, Cam 1 Maintained, Cam 2	ASD300-1 ASD300-2
	3 Spring-Ret. from Right, Cam1 Spring-Ret. from Right, Cam 2	ASD3100-1 ASD3100-2
	3 Spring-Ret. from Left, Cam 1 Spring-Ret. from Left, Cam 2	ASD3200-1 ASD3200-2
	2 Maintained	ASD2K00-RA
	2 Spring-Ret. from Right	ASD21K00-RL
	2 Spring-Ret. from Left	ASD22K00
	3 Maintained, Cam 1 Maintained, Cam 2	ASD3K00-1-RA ASD3K00-2-RA
	3 Spring-Ret. from Right, Cam1 Spring-Ret. from Right, Cam 2	ASD31K00-1-RLC ASD31K00-2-RLC
	3 Spring-Ret. from Left, Cam 1 Spring-Ret. from Left, Cam 2	ASD32K00-1-RLC ASD32K00-2-RLC
	Spring-Ret. from L/R, Cam 1 Spring-Ret. from L/R, Cam 2	ASD33K00-1-RC ASD33K00-2-RC

- 1. Order knobs, levers, color inserts separately (see below).
- 2. For key switches, keys are removable in all maintained positions. Other options available, contact IDEC for details.
- 3. See page A4-187 "Operator Truth Tables" for details of difference between cams.

① Color Codes

Knob/Lever Color	Code
Black	B
Blue	S
Green	G
Red	R
Yellow	Y
White	W

- 1. Knob/Lever not available in white.
- 2. Color inserts not available in Black.

Part Numbers: Handles and Inserts

Style	Part Number
Knob 	ASDHHY - ①
Lever 	ASDHHL - ①
Color Insert 	TW-HC1 - ①

 In place of ①, specify the Color Code.

Part Numbers: Contact Blocks

Style	Part Number	
	1N0	1NC
	BST-010 BST-010S (early make)	BST-001 BST-001S (late break)
Dummy Blocks	BST-D	

- 1. Dummy blocks (no contacts) are used with an odd number of contact blocks.
- 2. Combining BST-010S and BST-001S result in overlapping contacts (remain on, or closed, when switch is moved between two positions).

A4

Switches & Pilot Devices

Illuminated Selector Switches (Assembled)

A4

Switches & Pilot Devices



Assembled Illuminated Selector Switches

A SL D 2 (2) 126 11 D N - 111 - R - 24

Function

SL: Illuminated Selector Switch

Series Designation

D: TWTD Series

Number of Positions

2: 2-Position
3: 3-Position

Spring Return Action

Blank: Maintained
1: Spring return from Right
2: Spring return from Left
3: 2-Way spring return from Left and Right

Rated Operational Voltage (Primary)

Transformer	Full Voltage Type
126:120V AC	99: Full Voltage
246:240V AC	
486:480V AC	

Contact Arrangement

20: 2NO	02: 2NC
40: 4NO	04: 4NC
11: 1NO-1NC	22: 2NO-2NC

Lamp Voltage (Full Voltage Only)

6V: 6V AC/DC
12V: 12V AC/DC
24V: 24V AC/DC
120V: 120V AC
240V: 240V AC (LED only)

Lens Color Code

A: Amber
G: Green
R: Red
S: Blue
W: White
Y: Yellow

Circuit Code Number

See Circuit # column of Selector Switch Contact Arrangement Charts on page A4-185.

Lamp Type

Blank: Incandescent
D: LED



Use only when interpreting part numbers. Do not use for developing part numbers.

Illuminated Selector Switches (Assembled) con't

Part Numbers: Illuminated 2-Position Selector Switches

Contact	Style				Operator Position	Maintained 	Spring Return From Right 	Spring Return From Left
	Mounting	Operator Position		Transformer Full Voltage				
		L	R					
1NO 1NC	1	0	X	transformer full voltage	ASLD2 ④11⑤N-② ASLD29911⑤N-②-③	ASLD21 ④11⑤N-② ASLD219911⑤N-②-③	ASLD22 ④11⑤N-② ASLD229911⑤N-②-③	
	2	X	0					
2NO	1	0	X	transformer full voltage	ASLD2 ④20⑤N-② ASLD29920⑤N-②-③	ASLD21 ④20⑤N-② ASLD219920⑤N-②-③	ASLD22 ④20⑤N-② ASLD229920⑤N-②-③	
	2	0	X					
2NC	1	X	0	transformer full voltage	ASLD2 ④02⑤N-104-② ASLD29902⑤N-104-②-③	ASLD21 ④02⑤N-104-② ASLD219902⑤N-104-②-③	ASLD22 ④02⑤N-104-② ASLD229902⑤N-104-②-③	
	2	X	0					
2NO 2NC	1	0	X	transformer full voltage	ASLD2 ④22⑤N-② ASLD29922⑤N-②-③	ASLD21 ④22⑤N-② ASLD219922⑤N-②-③	ASLD22 ④22⑤N-② ASLD229922⑤N-②-③	
	2	X	0					
	3	0	X					
	4	X	0					
2NO 2NC	1	0	X	transformer full voltage	ASLD2 ④22⑤N-11-② ASLD29922⑤N-111-②-③	ASLD21 ④22⑤N-111-② ASLD219922⑤N-111-②-③	ASLD22 ④22⑤N-111-② ASLD229922⑤N-111-②-③	
	2	0	X					
	3	X	0					
	4	X	0					

② Lens/LED Color Codes

Color	Code
Amber	A
Green	G
Red	R
Blue	S
White	W
Yellow	Y

③ Full Voltage Codes

Voltage	Code
6V AC/DC	6V
12V AC/DC	12V
24V AC/DC	24V
120V AC	120V
240V AC (LED only)	240V

④ Transformer Voltage Codes

Voltage	Code
120VAC	126
240VAC	246
480VAC	486

⑤ Lamp Type Code

Lamp	Code
Incandescent	Blank
LED	D



6V secondary voltage (uses 6V lamps).

A4

Switches & Pilot Devices

Part Numbers: Illuminated 3-Position Selector Switches

Contact	Style				Operator Position	Maintained 	Spring Return From Right 	Spring Return From Left 	Spring Return Two-Way
	Mounting	Operator Position							
		L	C	R					
2NO	1	X	0	0	transformer full voltage	ASLD3 ④ 20⑤N-② ASLD39920⑤N-②-③	ASLD31 ④ 20⑤N-② ASLD319920⑤N-②-③	ASLD32 ④ 20D⑤N-② ASLD329920D⑤N-②-③	ASLD33 ④ 20D⑤N-② ASLD339920D⑤N-②-③
	2	0	0	X					
2NC	1	0	X	X	transformer full voltage	ASLD3 ④ 02⑤N-② ASLD39902⑤N-②-③	ASLD31 ④ 02⑤N-② ASLD319902⑤N-②-③	ASLD32 ④ 02D⑤N-② ASLD329902D⑤N-②-③	ASLD33 ④ 02D⑤N-② ASLD339902D⑤N-②-③
	2	X	X	0					
2NO 2NC	1	X	0	0	transformer full voltage	ASLD3 ④ 22⑤N-② ASLD39922⑤N-②-③	ASLD31 ④ 22⑤N-② ASLD319922⑤N-②-③	ASLD32 ④ 22D⑤N-② ASLD329922D⑤N-②-③	ASLD33 ④ 22D⑤N-② ASLD339922D⑤N-②-③
	2	0	0	X					
	3	0	X	X					
	4	X	X	0					
2NO 2NC	1	X	0	X	transformer full voltage	ASLD3 ④ 22⑤N-309-② ASLD39922⑤N-309-②-③	ASLD31 ④ 22⑤N-309-② ASLD319922⑤N-309-②-③	ASLD32 ④ 22D⑤N-309-② ASLD329922D⑤N-309-②-③	ASLD33 ④ 22D⑤N-309-② ASLD339922D⑤N-309-②-③
	2	X	X	0					
	3	0	X	0					
	4	0	0	X					
2NO 2NC	1	0	0	X	transformer full voltage	ASLD3 ④ 22⑤N-310-② ASLD39922⑤N-310-②-③	ASLD31 ④ 22⑤N-310-② ASLD319922⑤N-310-②-③	ASLD32 ④ 22D⑤N-310-② ASLD329922D⑤N-310-②-③	ASLD33 ④ 22D⑤N-310-② ASLD339922D⑤N-310-②-③
	2	0	0	X					
	3	0	X	0					
	4	0	0	X					
4NO	1	X	0	0	transformer full voltage	ASLD3 ④ 40⑤N-② ASLD39940⑤N-②-③	ASLD31 ④ 40⑤N-② ASLD319940⑤N-②-③	ASLD32 ④ 40⑤N-② ASLD329940⑤N-②-③	ASLD33 ④ 40⑤N-② ASLD339940⑤N-②-③
	2	0	0	X					
	3	X	0	0					
	4	0	0	X					
4NC	1	0	X	X	transformer full voltage	ASLD3 ④ 04⑤N-② ASLD39904⑤N-②-③	ASLD31 ④ 04⑤N-② ASLD319904⑤N-②-③	ASLD32 ④ 04⑤N-② ASLD329904⑤N-②-③	ASLD33 ④ 04⑤N-② ASLD339904⑤N-②-③
	2	X	X	0					
	3	0	X	X					
	4	X	X	0					



1. In place of ②, specify the Lens/LED Color Code, in place of ③, specify the Full Voltage (lamp voltage) Code, in place of ④, specify the Transformer Voltage Code and in place of ⑤ specify the Lamp Type Code.

2. The truth table indicates the operating position of contact block when the operator is switched to that position.

X = On (Closed Contacts) O = Off (Open Contacts)

—X—X = Overlapping Contacts: Remain on (closed contacts) when switch is moved between these positions

Illuminated Selector Switches (Sub-Assembled)

Transformer* + Contact Block + Operator + Lamp + Lense = Complete Part



A4

Switches & Pilot Devices

*Not required for full voltage units (use APD-F full voltage clips instead).



Part Numbers: Operators

Appearance/ Positions	Description	Part Number
	2 Maintained	ASLD200
	3 Maintained, Cam 1	ASLD300-1
	3 Maintained, Cam 2	ASLD300-2
	2 Spring-Ret. from Right	ASLD2100
	2 Spring-Ret. from Left	ASLD2200
	3 Spring-Ret. from Right, Cam 1	ASLD3100-1
	3 Spring-Ret. from Right, Cam 2	ASLD3100-2
	3 Spring-Ret. from Left, Cam 1	ASLD3200-1
	3 Spring-Ret. from Left, Cam 2	ASLD3200-2
	3 Spring-Ret. from L/R, Cam 1	ASLD3300-1
3 Spring-Ret. from L/R, Cam 2	ASLD3300-2	

Part Numbers: Lenses

Style	Part Number
Knob 	ASLNHU - ①

Part Numbers: Lamps

Type	Voltage	Part Number
	6V AC/DC	LSTD-6②
	12V AC/DC	LSTD-1②
	24V AC/DC	LSTD-2②
	120V AC	LSTD-H2②
	240V AC	LSTD-M4②
	6.3V AC/DC	IS-6
	12V AC/DC	IS-12
	24V AC/DC	IS-24
	120VAC	L-120L

1. In place of ②, specify the LED color code.
 2. The LED contains a current-limiting resistor and a protection diode.

Contact Blocks

Description	Part Number	
	1NO	1NC
	BST-010	BST-001
	BST-010S (early make)	BST-001S (late break)
	Dummy Blocks	BST-D

1. Dummy blocks (no contacts) are used with an odd number of contact blocks.
 2. Combining BST-010S and BST-001S result in overlapping contacts (make before break).

Part Numbers: Full Voltage Clips

Primary Voltage (50/60Hz)	Part Number
Full Voltage Clips (2 req'd for each unit)	APD-F

Part Numbers: Transformers

Description	Primary Voltage (50/60Hz)	Part Number
	120V AC	TWD-0126
	240V AC	TWD-0246
	480V AC	TWD-0486

6V secondary voltage

② Lens/LED Color Codes

Color	Code
Amber	A
Green	G
Red	R
Blue	S
White	W
Yellow	Y

Contact Arrangement Charts

How to Read Contact Arrangement Charts

To determine contact block mounting position, first make sure the selector switch is oriented as shown on the right

Contact Arrangement

Type and quantity of switch contacts

Circuit Number

* N/D = No designation

Contact Block Mounting

Position or mounting contact blocks on operator

Operator Position

Truth table indicates the operating position of contact block when operator is switched to that position.

X = On (Closed Contacts)
O = Off (Open Contacts)
X-X = Overlapping Contacts: Remain on (closed) when switch is moved between these two positions

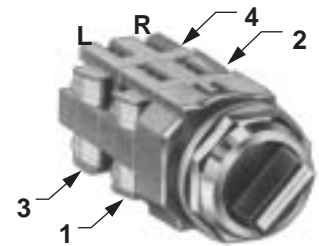

Contact Block Part Number

Part number to use when ordering sub-assembly contact blocks, as required for use with corresponding mounting position

Contact Arrangement Chart: 2-position Selector Switches

Style		Mounting Position	Operator Position		Contact Block Part Number	Description	Operator Part Number			
Contact	Circuit Number		L	R			Maintained	Spring Ret. from Rt.	Spring Ret. from Lt.	
			L ↙	R ↗			L ↙ R ↗	L ↙ R ↗	L ↙ R ↗	
1NO	N/D	1	O	X	BST-010	Knob/Lever Key	ASD200	ASD2100	ASD2200	
		2	O	O	BST-D	Illuminated Knob	ASD2K00	ASD21K00	ASD22K00	
1NC	116	1	X	O	BST-001	Knob/Lever Key	ASD200	ASD2100	ASD2200	
		2	O	O	BST-D	Illuminated Knob	ASD2K00	ASD21K00	ASD22K00	
1NO 1NC	N/D	1	O	X	BST-010	Knob/Lever Key	ASD200	ASD2100	ASD2200	
		2	X	O	BST-001	Illuminated Knob	ASD2K00	ASD21K00	ASD22K00	
1NO 1NC	103	1	X	O	BST-001	Knob/Lever Key	ASD200	ASD2100	ASD2200	
		2	O	X	BST-010	Illuminated Knob	ASD2K00	ASD21K00	ASD22K00	
1NO-EM 1NC-LB	600	1	O	X	BST-010S	Knob/Lever Key	ASD200	ASD2100	ASD2200	
		2	X	O	BST-001S	Illuminated Knob	ASD2K00	ASD21K00	ASD22K00	
1NO-EM 1NC-LB	601	1	X	O	BST-001S	Knob/Lever Key	ASD200	ASD2100	ASD2200	
		2	O	X	BST-010S	Illuminated Knob	ASD2K00	ASD21K00	ASD22K00	
2NO	N/D	1	O	X	BST-010	Knob/Lever Key	ASD200	ASD2100	ASD2200	
		2	O	X	BST-010	Illuminated Knob	ASD2K00	ASD21K00	ASD22K00	
2NC	104	1	X	O	BST-001	Knob/Lever Key	ASD200	ASD2100	ASD2200	
		2	X	O	BST-001	Illuminated Knob	ASD2K00	ASD21K00	ASD22K00	
2NO 2NC	N/D	1	O	X	BST-010	Knob/Lever Key Illuminated Knob	ASD200 ASD2K00 ASLD200	ASD2100 ASD21K00 ASLD2100	ASD2200 ASD22K00 ASLD2200	
		2	X	O	BST-001					
		3	O	X	BST-010					
		4	X	O	BST-001					
	110	110	1	X	O	BST-001	Knob/Lever Key Illuminated Knob	ASD200 ASD2K00 ASLD200	ASD2100 ASD21K00 ASLD2100	ASD2200 ASD22K00 ASLD2200
			2	O	X	BST-010				
			3	X	O	BST-001				
			4	O	X	BST-010				
	111	111	1	O	X	BST-010	Knob/Lever Key Illuminated Knob	ASD200 ASD2K00 ASLD200	ASD2100 ASD21K00 ASLD2100	ASD2200 ASD22K00 ASLD2200
			2	O	X	BST-010				
			3	X	O	BST-001				
			4	X	O	BST-001				
4NO	N/D	1	O	X	BST-010	Knob/Lever Key Illuminated Knob	ASD200 ASD2K00 ASLD200	ASD2100 ASD21K00 ASLD2100	ASD2200 ASD22K00 ASLD2200	
		2	O	X	BST-010					
		3	O	X	BST-010					
		4	O	X	BST-010					

A4

Switches & Pilot Devices

Contact Arrangement Chart: 3-Position Selector Switches

Style		Mounting Position	Operator Position			Contact Block Part Number	Description	Operator Part Number				
Contact	Circuit Number		L	C	R			Maintained	Spring Ret. from Rt.	Spring Ret. from Lt.	Two-Way	
A4 Switches & Pilot Devices	1NO 1NC	202	1	X	0	0	BST-010	Knob/Lever Key Illuminated Knob	ASD300-1 ASD3K00-1 ASLD300-1	ASD3100-1 ASD31K00-1 ASLD3100-1	ASD3200-1 ASD32K00-1 ASLD3200-1	ASD3300-1 ASD33K00-1 ASLD3300-1
			2	X	X	0	BST-001		ASD300-1 ASD3K00-1 ASLD300-1	ASD3100-1 ASD31K00-1 ASLD3100-1	ASD3200-1 ASD32K00-1 ASLD3200-1	ASD3300-1 ASD33K00-1 ASLD3300-1
		203	1	0	X	X	BST-001	Knob/Lever Key Illuminated Knob	ASD300-1 ASD3K00-1 ASLD300-1	ASD3100-1 ASD31K00-1 ASLD3100-1	ASD3200-1 ASD32K00-1 ASLD3200-1	ASD3300-1 ASD33K00-1 ASLD3300-1
			2	0	0	X	BST-010		ASD300-2 ASD3K00-2 ASLD300-2	ASD3100-2 ASD31K00-2 ASLD3100-2	ASD3200-2 ASD32K00-2 ASLD3200-2	ASD3300-2 ASD33K00-2 ASLD3300-2
		302	1	X	0	X	BST-010	Knob/Lever Key Illuminated Knob	ASD300-2 ASD3K00-2 ASLD300-2	ASD3100-2 ASD31K00-2 ASLD3100-2	ASD3200-2 ASD32K00-2 ASLD3200-2	ASD3300-2 ASD33K00-2 ASLD3300-2
			2	X	X	0	BST-001		ASD300-2 ASD3K00-2 ASLD300-2	ASD3100-2 ASD31K00-2 ASLD3100-2	ASD3200-2 ASD32K00-2 ASLD3200-2	ASD3300-2 ASD33K00-2 ASLD3300-2
	303	1	0	X	0	BST-001	Knob/Lever Key Illuminated Knob	ASD300-2 ASD3K00-2 ASLD300-2	ASD3100-2 ASD31K00-2 ASLD3100-2	ASD3200-2 ASD32K00-2 ASLD3200-2	ASD3300-2 ASD33K00-2 ASLD3300-2	
		2	0	0	X	BST-010		ASD300-1 ASD3K00-1 ASLD300-1	ASD3100-1 ASD31K00-1 ASLD3100-1	ASD3200-1 ASD32K00-1 ASLD3200-1	ASD3300-1 ASD33K00-1 ASLD3300-1	
	2NO	N/D	1	X	0	0	BST-010	Knob/Lever Key Illuminated Knob	ASD300-1 ASD3K00-1 ASLD300-1	ASD3100-1 ASD31K00-1 ASLD3100-1	ASD3200-1 ASD32K00-1 ASLD3200-1	ASD3300-1 ASD33K00-1 ASLD3300-1
			2	0	0	X	BST-010		ASD300-2 ASD3K00-2 ASLD300-2	ASD3100-2 ASD31K00-2 ASLD3100-2	ASD3200-2 ASD32K00-2 ASLD3200-2	ASD3300-2 ASD33K00-2 ASLD3300-2
	301	1	X	0	X	BST-010	Knob/Lever Key Illuminated Knob	ASD300-2 ASD3K00-2 ASLD300-2	ASD3100-2 ASD31K00-2 ASLD3100-2	ASD3200-2 ASD32K00-2 ASLD3200-2	ASD3300-2 ASD33K00-2 ASLD3300-2	
		2	0	0	X	BST-010		ASD300-1 ASD3K00-1 ASLD300-1	ASD3100-1 ASD31K00-1 ASLD3100-1	ASD3200-1 ASD32K00-1 ASLD3200-1	ASD3300-1 ASD33K00-1 ASLD3300-1	
2NC	304	1	0	X	0	BST-001	Knob/Lever Key Illuminated Knob	ASD300-2 ASD3K00-2 ASLD300-2	ASD3100-2 ASD31K00-2 ASLD3100-2	ASD3200-2 ASD32K00-2 ASLD3200-2	ASD3300-2 ASD33K00-2 ASLD3300-2	
		2	X	X	0	BST-001		ASD300-1 ASD3K00-1 ASLD300-1	ASD3100-1 ASD31K00-1 ASLD3100-1	ASD3200-1 ASD32K00-1 ASLD3200-1	ASD3300-1 ASD33K00-1 ASLD3300-1	
N/D	1	0	X	X	BST-001	Knob/Lever Key Illuminated Knob	ASD300-1 ASD3K00-1 ASLD300-1	ASD3100-1 ASD31K00-1 ASLD3100-1	ASD3200-1 ASD32K00-1 ASLD3200-1	ASD3300-1 ASD33K00-1 ASLD3300-1		
	2	X	X	0	BST-001		ASD300-1 ASD3K00-1 ASLD300-1	ASD3100-1 ASD31K00-1 ASLD3100-1	ASD3200-1 ASD32K00-1 ASLD3200-1	ASD3300-1 ASD33K00-1 ASLD3300-1		
2NO 2NC	N/D	1	X	0	0	BST-010	Knob/Lever Key Illuminated Knob	ASD300-1 ASD3K00-1 ASLD300-1	ASD3100-1 ASD31K00-1 ASLD3100-1	ASD3200-1 ASD32K00-1 ASLD3200-1	ASD3300-1 ASD33K00-1 ASLD3300-1	
		2	0	0	X	BST-010		ASD300-1 ASD3K00-1 ASLD300-1	ASD3100-1 ASD31K00-1 ASLD3100-1	ASD3200-1 ASD32K00-1 ASLD3200-1	ASD3300-1 ASD33K00-1 ASLD3300-1	
		3	0	X	X	BST-001		ASD300-1 ASD3K00-1 ASLD300-1	ASD3100-1 ASD31K00-1 ASLD3100-1	ASD3200-1 ASD32K00-1 ASLD3200-1	ASD3300-1 ASD33K00-1 ASLD3300-1	
		4	X	X	0	BST-001		ASD300-1 ASD3K00-1 ASLD300-1	ASD3100-1 ASD31K00-1 ASLD3100-1	ASD3200-1 ASD32K00-1 ASLD3200-1	ASD3300-1 ASD33K00-1 ASLD3300-1	
	210	1	0	X	X	BST-001	Knob/Lever Key Illuminated Knob	ASD300-1 ASD3K00-1 ASLD300-1	ASD3100-1 ASD31K00-1 ASLD3100-1	ASD3200-1 ASD32K00-1 ASLD3200-1	ASD3300-1 ASD33K00-1 ASLD3300-1	
		2	0	0	X	BST-010		ASD300-1 ASD3K00-1 ASLD300-1	ASD3100-1 ASD31K00-1 ASLD3100-1	ASD3200-1 ASD32K00-1 ASLD3200-1	ASD3300-1 ASD33K00-1 ASLD3300-1	
		3	0	X	X	BST-001		ASD300-2 ASD3K00-2 ASLD300-2	ASD3100-2 ASD31K00-2 ASLD3100-2	ASD3200-2 ASD32K00-2 ASLD3200-2	ASD3300-2 ASD33K00-2 ASLD3300-2	
		4	0	0	X	BST-010		ASD300-2 ASD3K00-2 ASLD300-2	ASD3100-2 ASD31K00-2 ASLD3100-2	ASD3200-2 ASD32K00-2 ASLD3200-2	ASD3300-2 ASD33K00-2 ASLD3300-2	
	308	1	X	0	X	BST-010	Knob/Lever Key Illuminated Knob	ASD300-2 ASD3K00-2 ASLD300-2	ASD3100-2 ASD31K00-2 ASLD3100-2	ASD3200-2 ASD32K00-2 ASLD3200-2	ASD3300-2 ASD33K00-2 ASLD3300-2	
		2	X	X	0	BST-001		ASD300-2 ASD3K00-2 ASLD300-2	ASD3100-2 ASD31K00-2 ASLD3100-2	ASD3200-2 ASD32K00-2 ASLD3200-2	ASD3300-2 ASD33K00-2 ASLD3300-2	
		3	X	0	X	BST-010		ASD300-2 ASD3K00-2 ASLD300-2	ASD3100-2 ASD31K00-2 ASLD3100-2	ASD3200-2 ASD32K00-2 ASLD3200-2	ASD3300-2 ASD33K00-2 ASLD3300-2	
		4	X	X	0	BST-001		ASD300-2 ASD3K00-2 ASLD300-2	ASD3100-2 ASD31K00-2 ASLD3100-2	ASD3200-2 ASD32K00-2 ASLD3200-2	ASD3300-2 ASD33K00-2 ASLD3300-2	
309	1	X	0	X	BST-010	Knob/Lever Key Illuminated Knob	ASD300-2 ASD3K00-2 ASLD300-2	ASD3100-2 ASD31K00-2 ASLD3100-2	ASD3200-2 ASD32K00-2 ASLD3200-2	ASD3300-2 ASD33K00-2 ASLD3300-2		
	2	X	X	0	BST-001		ASD300-2 ASD3K00-2 ASLD300-2	ASD3100-2 ASD31K00-2 ASLD3100-2	ASD3200-2 ASD32K00-2 ASLD3200-2	ASD3300-2 ASD33K00-2 ASLD3300-2		
	3	0	X	0	BST-001		ASD300-2 ASD3K00-2 ASLD300-2	ASD3100-2 ASD31K00-2 ASLD3100-2	ASD3200-2 ASD32K00-2 ASLD3200-2	ASD3300-2 ASD33K00-2 ASLD3300-2		
	4	0	0	X	BST-010		ASD300-2 ASD3K00-2 ASLD300-2	ASD3100-2 ASD31K00-2 ASLD3100-2	ASD3200-2 ASD32K00-2 ASLD3200-2	ASD3300-2 ASD33K00-2 ASLD3300-2		
310	1	0	X	0	BST-001	Knob/Lever Key Illuminated Knob	ASD300-2 ASD3K00-2 ASLD300-2	ASD3100-2 ASD31K00-2 ASLD3100-2	ASD3200-2 ASD32K00-2 ASLD3200-2	ASD3300-2 ASD33K00-2 ASLD3300-2		
	2	0	0	X	BST-010		ASD300-2 ASD3K00-2 ASLD300-2	ASD3100-2 ASD31K00-2 ASLD3100-2	ASD3200-2 ASD32K00-2 ASLD3200-2	ASD3300-2 ASD33K00-2 ASLD3300-2		
	3	0	X	0	BST-001		ASD300-2 ASD3K00-2 ASLD300-2	ASD3100-2 ASD31K00-2 ASLD3100-2	ASD3200-2 ASD32K00-2 ASLD3200-2	ASD3300-2 ASD33K00-2 ASLD3300-2		
	4	0	0	X	BST-010		ASD300-2 ASD3K00-2 ASLD300-2	ASD3100-2 ASD31K00-2 ASLD3100-2	ASD3200-2 ASD32K00-2 ASLD3200-2	ASD3300-2 ASD33K00-2 ASLD3300-2		
4NO	N/D	1	X	0	0	BST-010	Knob/Lever Key Illuminated Knob	ASD300-1 ASD3K00-1 ASLD300-1	ASD3100-1 ASD31K00-1 ASLD3100-1	ASD3200-1 ASD32K00-1 ASLD3200-1	ASD3300-1 ASD33K00-1 ASLD3300-1	
		2	0	0	X	BST-010		ASD300-1 ASD3K00-1 ASLD300-1	ASD3100-1 ASD31K00-1 ASLD3100-1	ASD3200-1 ASD32K00-1 ASLD3200-1	ASD3300-1 ASD33K00-1 ASLD3300-1	
		3	X	0	0	BST-010		ASD300-2 ASD3K00-2 ASLD300-2	ASD3100-2 ASD31K00-2 ASLD3100-2	ASD3200-2 ASD32K00-2 ASLD3200-2	ASD3300-2 ASD33K00-2 ASLD3300-2	
		4	0	0	X	BST-010		ASD300-2 ASD3K00-2 ASLD300-2	ASD3100-2 ASD31K00-2 ASLD3100-2	ASD3200-2 ASD32K00-2 ASLD3200-2	ASD3300-2 ASD33K00-2 ASLD3300-2	
305	1	X	0	X	BST-010	Knob/Lever Key Illuminated Knob	ASD300-2 ASD3K00-2 ASLD300-2	ASD3100-2 ASD31K00-2 ASLD3100-2	ASD3200-2 ASD32K00-2 ASLD3200-2	ASD3300-2 ASD33K00-2 ASLD3300-2		
	2	0	0	X	BST-010		ASD300-2 ASD3K00-2 ASLD300-2	ASD3100-2 ASD31K00-2 ASLD3100-2	ASD3200-2 ASD32K00-2 ASLD3200-2	ASD3300-2 ASD33K00-2 ASLD3300-2		
	3	X	0	X	BST-010		ASD300-2 ASD3K00-2 ASLD300-2	ASD3100-2 ASD31K00-2 ASLD3100-2	ASD3200-2 ASD32K00-2 ASLD3200-2	ASD3300-2 ASD33K00-2 ASLD3300-2		
	4	0	0	X	BST-010		ASD300-2 ASD3K00-2 ASLD300-2	ASD3100-2 ASD31K00-2 ASLD3100-2	ASD3200-2 ASD32K00-2 ASLD3200-2	ASD3300-2 ASD33K00-2 ASLD3300-2		
4NC	N/D	1	0	X	X	BST-001	Knob/Lever Key Illuminated Knob	ASD300-1 ASD3K00-1 ASLD300-1	ASD3100-1 ASD31K00-1 ASLD3100-1	ASD3200-1 ASD32K00-1 ASLD3200-1	ASD3300-1 ASD33K00-1 ASLD3300-1	
		2	X	X	0	BST-001		ASD300-1 ASD3K00-1 ASLD300-1	ASD3100-1 ASD31K00-1 ASLD3100-1	ASD3200-1 ASD32K00-1 ASLD3200-1	ASD3300-1 ASD33K00-1 ASLD3300-1	
		3	0	X	X	BST-001		ASD300-1 ASD3K00-1 ASLD300-1	ASD3100-1 ASD31K00-1 ASLD3100-1	ASD3200-1 ASD32K00-1 ASLD3200-1	ASD3300-1 ASD33K00-1 ASLD3300-1	
		4	X	X	0	BST-001		ASD300-1 ASD3K00-1 ASLD300-1	ASD3100-1 ASD31K00-1 ASLD3100-1	ASD3200-1 ASD32K00-1 ASLD3200-1	ASD3300-1 ASD33K00-1 ASLD3300-1	
314	1	0	X	0	BST-001	Knob/Lever Key Illuminated Knob	ASD300-2 ASD3K00-2 ASLD300-2	ASD3100-2 ASD31K00-2 ASLD3100-2	ASD3200-2 ASD32K00-2 ASLD3200-2	ASD3300-2 ASD33K00-2 ASLD3300-2		
	2	X	X	0	BST-001		ASD300-2 ASD3K00-2 ASLD300-2	ASD3100-2 ASD31K00-2 ASLD3100-2	ASD3200-2 ASD32K00-2 ASLD3200-2	ASD3300-2 ASD33K00-2 ASLD3300-2		
	3	0	X	0	BST-001		ASD300-2 ASD3K00-2 ASLD300-2	ASD3100-2 ASD31K00-2 ASLD3100-2	ASD3200-2 ASD32K00-2 ASLD3200-2	ASD3300-2 ASD33K00-2 ASLD3300-2		
	4	X	X	0	BST-001		ASD300-2 ASD3K00-2 ASLD300-2	ASD3100-2 ASD31K00-2 ASLD3100-2	ASD3200-2 ASD32K00-2 ASLD3200-2	ASD3300-2 ASD33K00-2 ASLD3300-2		

- Each operator sub-assembly is available as a "-1" and a "-2" for 3-position selector switches. The internal cam of a "-1" is different from that of a "-2". This results in designated combinations of open and closed contacts in the various operator positions.
- N/D = No circuit number designation required in assembled part number.
- X = On (closed contacts) O = Off (open contacts). X-X Overlapping contacts remain on (closed) when switch is moved between these two positions.

Operator Truth Tables

Use the following tables to build custom selector switches.

2 Position Selector Switches

	Contact	Mounting Position	Operator Position	
			Left	Right
ASD200	BST-010 (NO)	L	0	X
		R	0	X
	BST-001 (NC)	L	X	0
		R	X	0
	BST-010S (NO-EM)	L	0	X
		R	0	X
	BST-001S (NC-LB)	L	X	0
		R	X	0

3 Position Selector Switches

	Contact	Mounting Position	Operator Position		
			Left	Center	Right
ASD300-1 ASLD300-1 ASD3K00-1	BST-010 (NO)	L	X	0	0
		R	0	0	X
	BST-001 (NC)	L	0	X	X
		R	X	X	0
	BST-010S (NO-EM)	L	X	0	0
		R	0	0	X
	BST-001S (NC-LB)	L	0	X	X
		R	X	X	0

	Contact	Mounting Position	Operator Position		
			Left	Center	Right
ASD300-2 ASLD300-2 ASD3K00-2	BST-010 (NO)	L	X	0	X
		R	0	0	X
	BST-001 (NC)	L	0	X	0
		R	X	X	0
	BST-010S (NO-EM)	L	X	0	X
		R	0	0	X
	BST-001S (NC-LB)	L	0	X	0
		R	X	X	0











1. For Operator Truth Tables, see next page.
2. For examples of how to assemble selector switches, see A3-82.

3 Position Push/Pull Switches

	Contact	Operator Position		
		Pull	Normal	Push
AYLD22	BST-010 (NO)	0	0	X
	BST-001 (NC)	X	0	0
	BST-010S (NO-EM)	0	X	X
	BST-001S (NC-LB)	X	X	0

Accessories — TWTD Series

Lamp Removal Tool		Tool used to install LED's and incandescent lamps.	OR-55
Metal Bezel		Replacement locking ring/bezel	Standard octagonal units (chrome-pl.). OG-81
			Extended, non-illuminated (chrome-pl.). OG-82
			Extended, illuminated (chrome-pl.). OG-83L
			Jumbo Mushroom Shallow Shroud ABN4G
			Jumbo Mushroom Deep Shroud ABN4F
Plastic Bezel		Black plastic locking ring/bezel	OGP11B
Boot/Cover		Used to cover and protect push-buttons.	In place of ①, specify neoprene Rubber Boot color: B (black), G (green), R (red), Y (yellow) OC-11 ①
			Flush units (clear plastic -40° to +60°C). OC-121
			Extended units (clear plastic -40° to +60°C). OC-122
Anti-Rotation Ring		Plastic washer For nameplates or panels that should not be scratched.	OGL-D1T
		Thrust washer/Anti-rotation ring for use with notched panel cutout.	OGL-D1S
Mounting Hole Plug		Plugs used to fill unused 30mm panel cutouts.	Plastic with locking nut attached. OBP-11
			Metal with locking nut attached OB-11
			Grey rubber (-5° to +60°C) OB-13
Terminal Tab Adaptor		Tab #250 17/64" x 3/64" (6.35mm x 0.8mm): Single tab	TW-FA1
Full Voltage Adaptor		Used on all full voltage illuminated units. Two required per unit. (M3.5 screw and saddle)	APD-F
Lock Out Adaptor		Used to provide lockout protection for TWTD pushbuttons and knob selectors. Ø 1-13/64" (30mm)	OL-KL1
Replacement Keys		Pair of Keys (#0)	TW-SK

Accessories con't

Part Numbers: Fingersafe Covers for TWTD Series

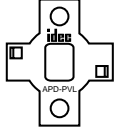
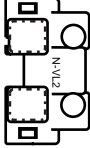
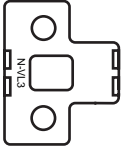
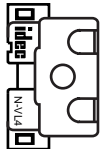
Appearance	Description	Used with	Part Number
	Fingersafe terminal cover, for full voltage pilot lights, adds 3mm to overall depth	APD199... full voltage pilot lights	APD-PVL
	Fingersafe terminal cover, for contact blocks, adds 3mm to overall depth	Non-Illuminated pushbuttons ABD..., and AOD...	N-VL2
	Fingersafe terminal cover, adds 1.5mm to overall depth	Transformer pilot lights and illuminated units	N-VL3
	Fingersafe terminal cover, adds 4 mm to depth	Full voltage illuminated pushbuttons	N-VL4

A4

Switches & Pilot Devices



Dimensions on page A4-192.

Nameplates — TWTD Series

Part Numbers: Nameplates

		NALD	NAKD	NAQD	HNAV
Dimensions					
Description		Part Number	Part Number	Part Number	Part Number
Nameplate (blank)	Black	NALD-B	NAKD-B	NAQD-B	HNAV-0
	Red	NALD-R	NAKD-R	NAQD-R	
Nameplate (engraved)		NALD-①	NAKD-①	NAQD-①	HNAV-27 "Emergency Stop"

1. Nameplates are made of 0.031" aluminum. Lettering is white letters engraved on black background.
2. In place of ①, insert either the standard legend code from table below or custom engraving delimited by " ".
3. HNAV available in yellow only.

* Standard Legend Codes

Pushbuttons				Pushbuttons/Selector Switches				Selector Switches	
Legend	Code	Legend	Code	Legend	Code	Legend	Code	Legend	Code
AUTO	101	OPEN	116	AUTO-MAN	201			AUTO-MAN-OFF	301
CLOSE	102	OUT	117	CLOSE-OPEN	202			AUTO-OFF-MAN	302
DOWN	103	RAISE	118	DOWN-UP	203			CLOSE-OFF-OPEN	303
*EMERG.STOP	104	RESET	119	FAST-SLOW	204			DOWN-OFF-SLOW	304
FAST	105	REVERSE	120	FOR-REV	205	REV-FOR	216	FAST-OFF-SLOW	305
FORWARD	106	RUN	121	HAND-AUTO	206	RUN-JOG	217	FOR-OFF-REV	306
HAND	107	SLOW	122	HIGH-LOW	207	RUN-SAFE	218	LEFT-OFF-RIGHT	307
HIGH	108	START	123	JOG-RUN	208	SAFE-RUN	219	LOWER-OFF-RAISE	308
IN	109	*STOP	124	LEFT-RIGHT	209	SLOW-FAST	220	OFF-MAN-AUTO	309
INCH	110	STOP	125	LOWER-RAISE	210	START-STOP	221	OFF-SLOW-FAST	310
JOG	111	TEST	126	MAN-AUTO	211	STOP-START	222	OFF-1-2	311
LOW	112	UP	127	OFF-ON	212	UP-DOWN	223	OPEN-OFF-CLOSE	312
LOWER	113	I (Int'l On)	150	ON-OFF	213			SLOW-OFF-FAST	313
OFF	114	O (Int'l Off)	151	OPEN-CLOSE	214			SUMMER-OFF-WINTER	314
ON	115	EMO	152	RAISE-LOWER	215			UP-OFF-DOWN	315
								1-OFF-2	316
								HAND-OFF-AUTO	317

1. *Available in Red as standard legend code 104 and 124. To order engraved nameplate and codes, add legend code to nameplate part number. Character height based on the number of characters, space and size of nameplate. Standard character size is 3/16".
2. Nameplates with standard legends are the same list price as blank nameplates. Special engravings, additional cost.

To specify engraving instructions, use the Nameplate order form on next page.

Nameplates Order Form — TWTD Series

Copy this order form and use it to specify Letter Height, Custom Engravings, Location of Engraving on Nameplate, and Quantity Desired. To insure engraving accuracy, fax it to your IDEC representative or Distributor.

Your Company:	_____	IDEC Rep/Distributor Contact:	_____
Name:	_____	PO number (if known):	_____
Telephone:	_____	IDEC Rep/Distributor Phone:	_____
Fax & Email	_____	IDEC Rep/Distributor Fax & Email	_____

A4

NALD Nameplate

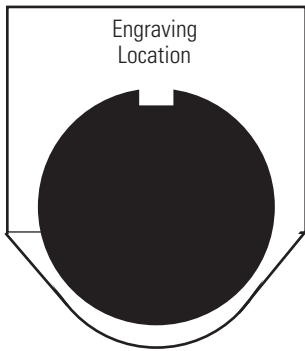

Step 1. Choose Letter Size - 7/64" or 1/8".
Check the box for the letter size you want. Then write your lettering in box below checkboxes. Note: 1/8" size letters cannot exceed 13 characters.

Sample Letter Sizes

7/64" Letters:

A B C D

1/8" Letters:

A B C D

7/64"
Letter
Size

16 characters max
(for 7/64" size letters)

1/8"
Letter
Size

13 characters max
(for 1/8" size letters)

Step 2. Specify Quantity.
Enter the number of nameplates desired in the box on the right.

Qty

1 2 3 4 5 6 7 8 9 10 11 12 13 14 15 16

Switches & Pilot Devices

NAKD Nameplate

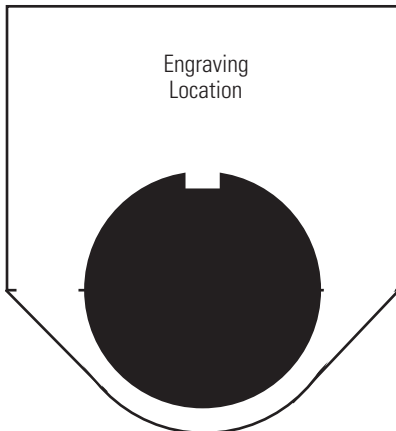

Step 1. 1/8" Letter Size Only Specify Lettering
Write your lettering in box to the right. Maximum 17 characters per line, maximum 4 lines.

1 2 3 4 5 6 7 8 9 10 11 12 13 14 15 16 17

Step 2. Specify Quantity.
Enter the number of nameplates desired in the box on the right.

Qty

Sample Letter Size
1/8" Letters: A B C D

NAQD Nameplate

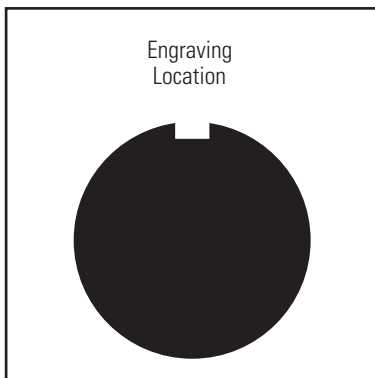

Step 1. Choose Letter Size - 7/64" or 1/8".
Check the box for the letter size you want. Then write your lettering in box below checkboxes. Note: 1/8" size letters cannot exceed 16 characters.

7/64"
Letter
Size

20 characters max
(for 7/64" size letters)

1/8"
Letter
Size

16 characters max
(for 1/8" size letters)

Step 2. Specify Quantity.
Enter the number of nameplates desired in the box on the right.

Qty

1 2 3 4 5 6 7 8 9 10 11 12 13 14 15 16 17 18 19 20

Sample Letter Sizes
7/64" Letters: A B C D
1/8" Letters: A B C D

A4

Switches & Pilot Devices

Dimensions — TWTD Series

Pushbutton

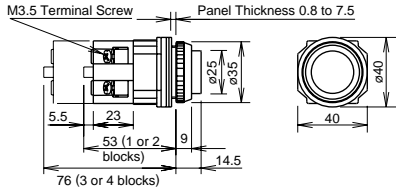

Mushroom Pushbutton w/Full Shroud

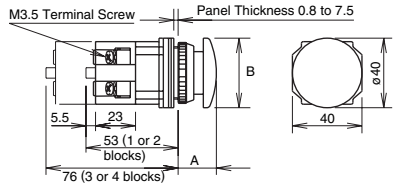

Pushbuttons	Dimension A	Dimension B
Flush	0.351" (9mm)	Ø 0.975" (25mm)
Extended	0.566" (14.5mm)	Ø 0.975" (25mm)
Extended w/Full Shroud	0.663" (17mm)	Ø 1.11" (28.5mm)
Mushroom	0.858" (22mm)	Ø 1.56" (40mm)
Mushroom w/Full Shroud	0.936" (24mm)	Ø 1.87" (48mm)
Jumbo Mushroom	1.13" (29mm)	Ø 2.54" (65mm)
Mushroom, Pushlock Turn Reset and Push-Pull	*0.975" (25mm) **0.975" (25mm)	Ø 1.56" (40mm) Ø 1.56" (40mm)

Note: *Dimension when operator is in reset position.
**Dimension when operator is in pull position.

Illuminated Pushbuttons

w/AC Adapter w/Transformer

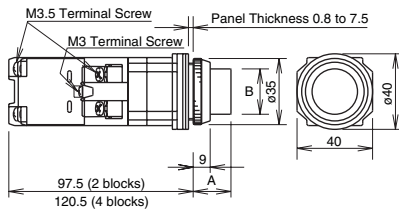

Full Voltage

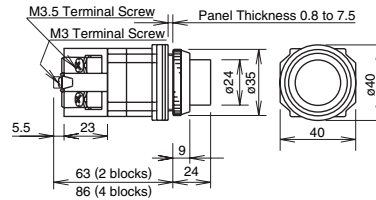

Illuminated Pushbuttons	Dimension A	Dimension B
Flush w/Full Shroud	0.975" (25mm) 0.995" (25.5mm)	Ø 0.936" (24mm) Ø 0.936" (24mm)
Extended w/Full Shroud	0.741" (19mm) 0.761" (19.5mm)	Ø 0.936" (24mm) Ø 0.936" (24mm)
Ø 1.56" (40mm) Mushroom Pushlock Turn Reset, Push-Pull	*0.975" (25mm) **0.975" (25mm)	Ø 1.56" (40mm) Ø 1.56" (40mm)

Note: *Dimension when operator is in reset position.
**Dimension when operator is in pull position.

Pilot Lights

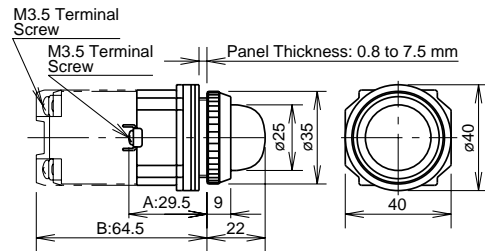

Selector Switches Knob

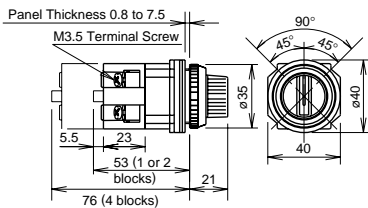

Lever

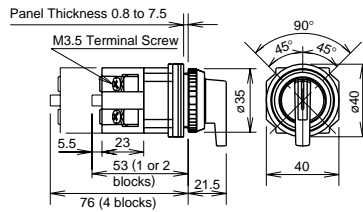

Key

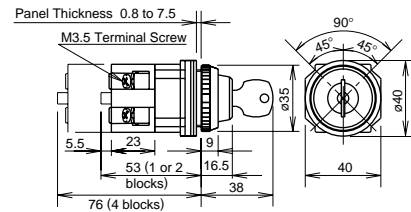

Illuminated Knob

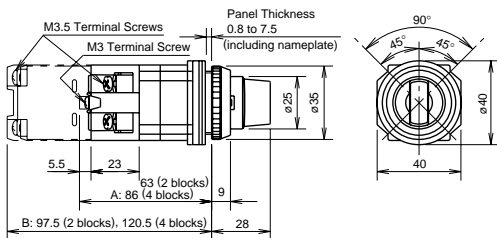

All measurements in mm.

Dimensions — TWTD Series con't

Selector Switches Panel Cut-Out

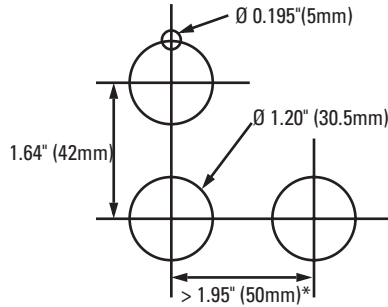

1. *Jumbo Mushroom < 2.61" (66mm)
2. Minimum mounting centers are applicable to switches with one stack of contact blocks. When mounting two stacks of contact blocks, minimum centers should allow for access to wiring.
3. The Ø 0.195" (Ø 5mm) recess is necessary when either the nameplate or anti-rotation ring is used.

Accessory Dimensions

OL-KL1 Lock-Out Adaptor

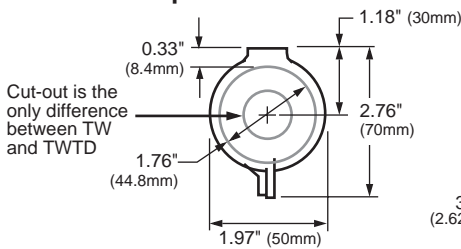

Cut-out is the only difference between TW and TWTD

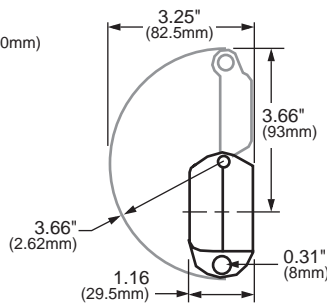

OC-31 Pushbutton Clear Boot

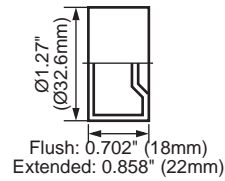

OGL-31 Anti-Rotation Ring

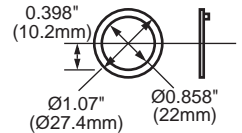

OB-31 Mounting Hole Rubber Plug

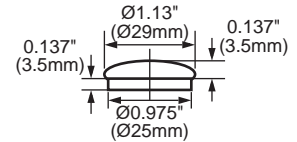

Finger-Safe Cover

N-VL2

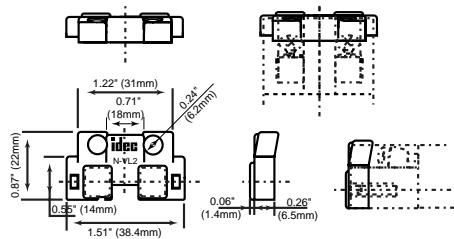

N-VL3

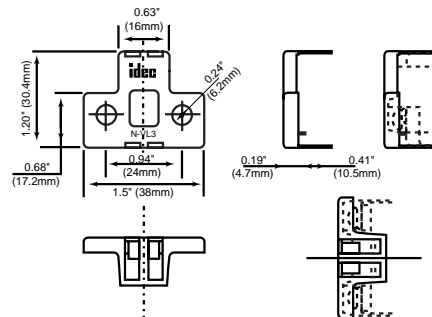

N-VL4

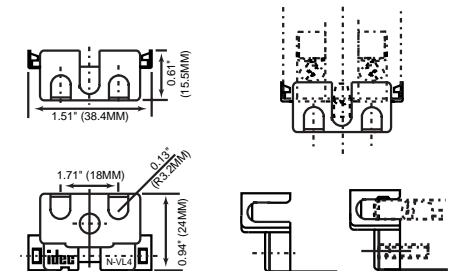

APD-PVL

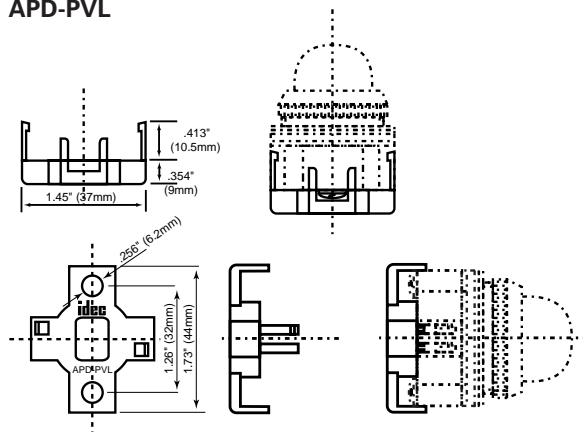

Instructions — TWTD Series

A4

Switches & Pilot Devices

Adjustment for Panel Thickness

Each unit is shipped with several waterproof gaskets which are 0.06" (1.5mm) and 0.12" (3mm) thick. Combine the gaskets for a dimension approximately equal to panel thickness and install between the bezel and the body of the unit.

A trim washer must be used with a thrust washer or a nameplate to prevent the control unit from rotating in the mounting hole. When using anti-rotation rings (trim washer with thrust washer or nameplate), install as shown below.

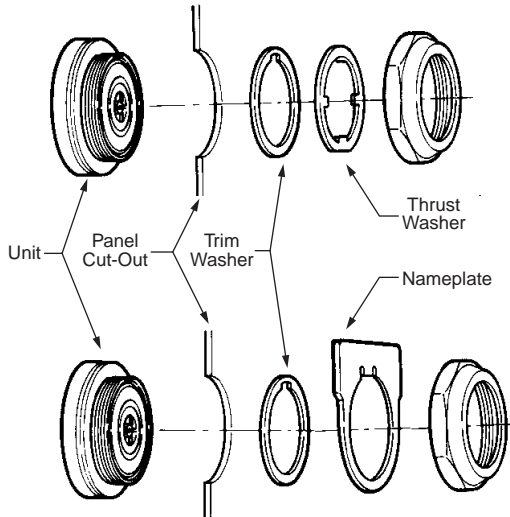

Selector Switches

The operator shaft of each unit has a recess to identify in which direction to install the handle. Align the handle with the recess. Press color insert (TW-HC1) into the Standard Operating Positions.

Standard operation positions

2-Position, 90°



3-Position, 45°

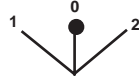

Non-Illuminated 3-Position Operators



Installation of TWTD Series Units

TWTD Pilot Lights

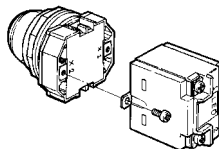

TWTD Illuminated Pushbuttons, TWTD Selector Switches (Transformer or Full Voltage)

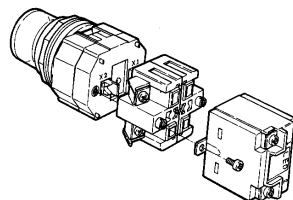

Terminal X1 = Positive
Terminal X2 = Negative

Installation of LED Illuminated Units—Transformer units are recommended for use in areas subjected to inductive noise. When using full voltage types, install a protection diode as shown below. Use diode with AC power supply to protect against reverse polarity. Use with DC power supply to protect against surges and noise.



Make sure that LED illuminated units are installed with correct polarity, as indicated at the terminals.

Application Example For Push-To-Test Pilot Light

A typical application of illuminated pushbuttons is a push-to-test pilot light which can be used to check the lamp/LED circuit.

Transformer/AC-Adapter Circuit

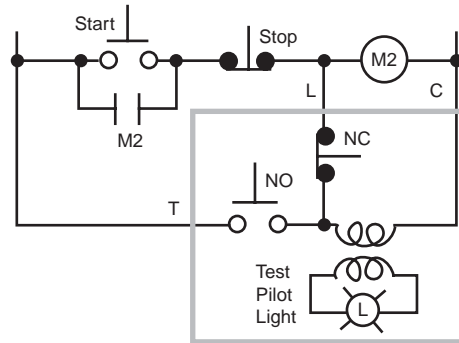

Full Voltage Circuit

