

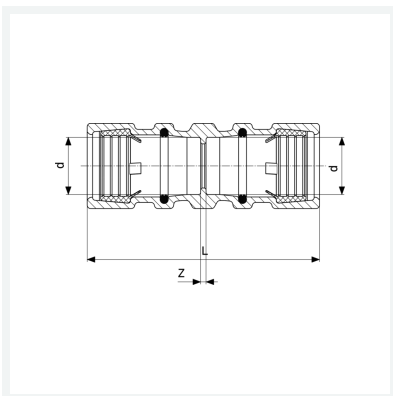

**Geopress-Muffe
mit SC-Contur**
- Pressanschlüsse
Ausstattung
Dichtelemente EPDM
Modell 9615TW

Artikel 767 075



Eigenschaften

Rohraußendurchmesser	d	25
Z-Maß	Z	8 mm
Länge	L	98 mm
Gewicht	326 g	
Volumen	310,8 cm ³	
Werkstoff	Rotguss	