

## Precision stepped jaw

Accessories for art. no.: 28848 and 28862



### Application:

For screwing on to the fixed and moving jaw.

### Execution:

- Hardened and ground.

### Delivery:

1x precision stepped jaw

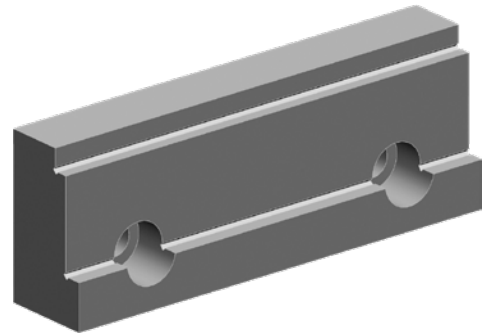

<b>Art. no.</b>	<b>28848 212</b>
<b>Brand</b>	ROEMHELD
<b>Manufacturer Part Number</b>	520820003
<b>Type</b>	Stepped jaw
<b>Jaw design</b>	With steps
<b>Jaws width</b>	160 mm
<b>Jaws thickness</b>	25 mm
<b>Jaws height</b>	54 mm
<b>Section, width</b>	5 mm
<b>Section, height</b>	45 mm
<b>Gross Weight</b>	1.320 kg
<b>Product Group</b>	283