

## Datasheet

### Banana Silicone Lead

No. 1612671 // MSB-501 red 5 m

No. 1612688 // MSB-501 black 5 m

No. 1612694 // MSB-501 blue 5 m

No. 1612695 // MSB-501 white 5 m

No. 1612707 // MSB-501 yellow 5 m

No. 1612709 // MSB-501 green 5 m

The VOLTCRAFT safety test lead MSB-501 is optimized for electrical connections and for measurements in the laboratory and craft. The rated current is 10 A and the rated voltage is 1000 V / AC (AC voltage) and 1000 V / DC (DC voltage). According to CAT IV, the nominal voltage is 600 V / AC and 1000 V / DC.

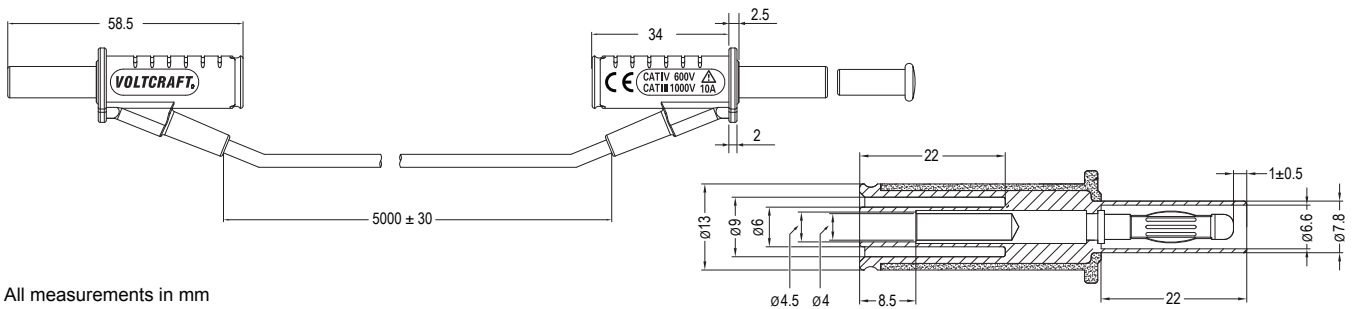

All measurements in mm

### Technical data

Cable length	5.0 m
Conductor size	18 AWG
Pin dimensions	4 mm
Type of contact	Spring-loaded pin
Cable type	Silicone
Cable specifications	Ø 3.6 mm, 0.85 mm <sup>2</sup>
Wire stranding	62 x 7 PLY
Rated voltage	CAT III 1000V, CAT IV 600V
Measurement category acc. to IEC61010	CAT III / CAT IV
Rated current	10 A
Contact resistance	0.03 Ω

### Material

Contact material	Contact pin: brass // Contact spring: copper-beryllium
Contact surface material	Nickel, alternative gold
Housing material	PP & TPE
Cable material	Silicone
Cable conductor material	Copper
Wire conductor	Copper (tin-coated) +200D bulletproof wire
Cable insulation layer	Silica gel
Cable coating	Silica gel
Available colours	Black // Red // Blue // Green // Yellow // White

### Environmental conditions

Temperature range	-15 to +70 °C
-------------------	---------------

### Inflammable class

Housing	UL 94 V-0
---------	-----------

This is a publication by Conrad Electronic SE, Klaus-Conrad-Str. 1, D-92240 Hirschau (www.conrad.com). All rights including translation reserved. Reproduction by any method, e.g. photocopy, microfilming, or the capture in electronic data processing systems require the prior written approval by the editor. Reprinting, also in part, is prohibited. This publication represent the technical status at the time of printing.

© Copyright 2022 by Conrad Electronic SE. 1612671.1612688.1612694.1612695.1612707.1612709\_V3\_1221\_01\_PIX\_ds