

TECHNISCHES DATENBLATT

SPGN12-55

Eigenschaften:

- ✓ AGM-Batterien
- ✓ Long Life nach Eurobat
- ✓ Hohe Energieeffizienz
- ✓ Hohe Gasrekombination
- ✓ Niedrige Selbstentladung
- ✓ Einfache Handhabung und Installation

Anwendungen:

- ✓ USV-Anlagen
- ✓ Rechenzentren
- ✓ Telekommunikation
- ✓ Energieversorgung
- ✓ Erneuerbare Energien
- ✓ Sicherheitsbeleuchtung
- ✓ Universelle Stromspeicher
- ✓ Dieselstart

Standards:

- ✓ IEC 60896-21/22:2004
- ✓ JIS C8702-1/2:2009
- ✓ Eurobat 2015
- ✓ EN 50272-2

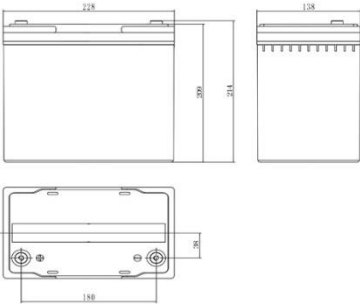
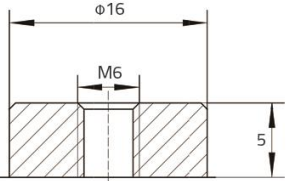
Bild:	Zeichnung:			Anschlusspol:
				 <p style="text-align: center;">SP-28</p>
Bezeichnung:	SPGN12-55			
Abmessungen:	Länge	Breite	Höhe	
	228 mm	138 mm	209/214 mm	
Gewicht:	17,20 kg			
Design-Life:	12 Jahre			
Kapazität (25°C; 1,8 V/Z):	C ₁₀	C ₈	C ₃	C ₁
	55,00 Ah	53,04 Ah	42,81 Ah	33,03 Ah
Innenwiderstand:	6,40 mΩ			
Max. Entladestrom (5 sec.):	660 A			
Ladung:	Zyklische Anwendung 2,40 (-4mV/°C)		Stationäre Anwendung 2,27 (-3mV/°C), Starkladung 2,40 V/Z	

Entladeströme in Ampere (25 °C)											
U _s (V/Zelle)	5min	10min	15min	20min	30min	1h	2h	3h	8h	10h	20h
1,60	207,00	168,00	122,55	101,00	74,30	40,64	21,95	16,35	7,38	6,12	3,15
1,65	195,00	160,09	117,80	95,69	71,16	38,46	20,98	15,88	7,18	5,95	3,06
1,67	188,00	155,04	114,00	93,67	69,47	37,63	20,61	15,61	7,09	5,88	3,03
1,70	183,00	150,00	111,15	91,27	67,50	36,64	20,16	15,28	7,00	5,80	2,99
1,75	170,00	140,90	105,45	87,09	63,84	35,19	19,28	14,77	6,80	5,64	2,90
1,80	165,00	130,00	99,75	82,96	60,18	33,03	18,51	14,27	6,63	5,50	2,83

Entladeleistung in Watt/Zelle (25 °C)											
U _s (V/Zelle)	5min	10min	15min	20min	30min	1h	2h	3h	8h	10h	20h
1,60	385,00	289,00	226,00	179,04	132,00	78,40	46,56	33,84	14,86	12,44	6,41
1,65	370,00	282,00	219,00	173,28	128,00	76,20	45,24	33,15	14,50	12,14	6,25
1,67	362,00	275,00	215,00	169,92	126,00	75,20	44,61	32,41	14,41	12,07	6,21
1,70	355,00	262,00	209,00	166,08	124,00	74,10	43,80	31,55	14,26	11,94	6,15
1,75	337,00	250,00	202,00	160,32	120,00	72,00	42,47	30,83	13,90	11,64	5,99
1,80	320,00	235,00	194,00	154,56	116,00	69,80	41,05	29,58	13,67	11,45	5,90

