

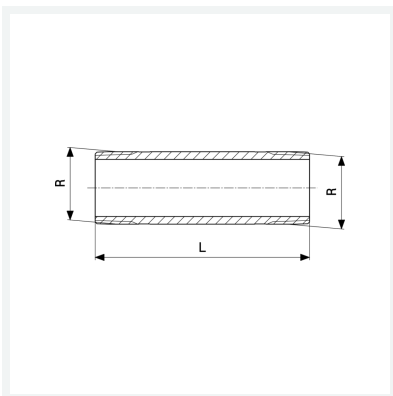

Langnippel
- R-Gewinde
Modell 3530

Artikel 319 816



Eigenschaften

Länge	L	120
Außengewinde kegelig	R	2
Länge	L	120 mm
Gewicht	659,6 g	
Volumen	828,8 cm ³	
Werkstoff	Rotguss oder Siliziumbronze	