

## EFM32WG995 DATASHEET

F256/F128/F64

Preliminary

- **ARM Cortex-M4 CPU platform**
  - High Performance 32-bit processor @ up to 48 MHz
  - DSP instruction support and floating-point unit
  - Memory Protection Unit
- **Flexible Energy Management System**
  - 20 nA @ 3 V Shutoff Mode
  - 0.4µA @ 3 V Shutoff Mode with RTC
  - 0.65 µA @ 3 V Stop Mode, including Power-on Reset, Brown-out Detector, RAM and CPU retention
  - 0.95 µA @ 3 V Deep Sleep Mode, including RTC with 32.768 kHz oscillator, Power-on Reset, Brown-out Detector, RAM and CPU retention
  - 67 µA/MHz @ 3 V Sleep Mode
  - 230 µA/MHz @ 3 V Run Mode, with code executed from flash
- **256/128/64 KB Flash**
- **32 KB RAM**
- **93 General Purpose I/O pins**
  - Configurable push-pull, open-drain, pull-up/down, input filter, drive strength
  - Configurable peripheral I/O locations
  - 16 asynchronous external interrupts
  - Output state retention and wake-up from Shutoff Mode
- **12 Channel DMA Controller**
- **12 Channel Peripheral Reflex System (PRS) for autonomous inter-peripheral signaling**
- **Hardware AES with 128/256-bit keys in 54/75 cycles**
- **Timers/Counters**
  - 4x 16-bit Timer/Counter
    - 4x3 Compare/Capture/PWM channels
    - Dead-Time Insertion on TIMER0
  - 16-bit Low Energy Timer
  - 1x 24-bit Real-Time Counter and 1x 32-bit Real-Time Counter
  - 3x 16/8-bit Pulse Counter
  - Watchdog Timer with dedicated RC oscillator @ 50 nA
- **Integrated LCD Controller for up to 8x36 segments**
  - Voltage boost, adjustable contrast and autonomous animation
- **Backup Power Domain**
  - RTC and retention registers in a separate power domain, available in all energy modes
  - Operation from backup battery when main power drains out
- **External Bus Interface for up to 4x256 MB of external memory mapped space**
  - TFT Controller with Direct Drive
- **Communication interfaces**
  - 3x Universal Synchronous/Asynchronous Receiver/Transmitter
    - UART/SPI/SmartCard (ISO 7816)/IrDA/I2S
  - 2x Universal Asynchronous Receiver/Transmitter
  - 2x Low Energy UART
    - Autonomous operation with DMA in Deep Sleep Mode
  - 2x I<sup>2</sup>C Interface with SMBus support
    - Address recognition in Stop Mode
  - Universal Serial Bus (USB) with Host & OTG support
    - Fully USB 2.0 compliant
    - On-chip PHY and embedded 5V to 3.3V regulator
- **Ultra low power precision analog peripherals**
  - 12-bit 1 Msamples/s Analog to Digital Converter
    - 8 single ended channels/4 differential channels
    - On-chip temperature sensor
  - 12-bit 500 ksamples/s Digital to Analog Converter
  - 2x Analog Comparator
    - Capacitive sensing with up to 16 inputs
  - 3x Operational Amplifier
    - 6.1 MHz GBW, Rail-to-rail, Programmable Gain
  - Supply Voltage Comparator
- **Low Energy Sensor Interface (LESENSE)**
  - Autonomous sensor monitoring in Deep Sleep Mode
  - Wide range of sensors supported, including LC sensors and capacitive buttons
- **Ultra efficient Power-on Reset and Brown-Out Detector**
- **Debug Interface**
  - 2-pin Serial Wire Debug interface
    - 1-pin Serial Wire Viewer
  - Embedded Trace Module v3.5 (ETM)
- **Pre-Programmed USB/UART Bootloader**
- **Temperature range -40 to 85 °C**
- **Single power supply 1.85 to 3.8 V**
- **BGA120 package**

32-bit ARM Cortex-M0+, Cortex-M3 and Cortex-M4 microcontrollers for:

- Energy, gas, water and smart metering
- Health and fitness applications
- Smart accessories
- Alarm and security systems
- Industrial and home automation



# 1 Ordering Information

Table 1.1 (p. 2) shows the available EFM32WG995 devices.

**Table 1.1. Ordering Information**

| Ordering Code         | Flash (kB) | RAM (kB) | Max Speed (MHz) | Supply Voltage (V) | Temperature (°C) | Package |
|-----------------------|------------|----------|-----------------|--------------------|------------------|---------|
| EFM32WG995F64-BGA120  | 64         | 32       | 48              | 1.85 - 3.8         | -40 - 85         | BGA120  |
| EFM32WG995F128-BGA120 | 128        | 32       | 48              | 1.85 - 3.8         | -40 - 85         | BGA120  |
| EFM32WG995F256-BGA120 | 256        | 32       | 48              | 1.85 - 3.8         | -40 - 85         | BGA120  |

Visit [www.silabs.com](http://www.silabs.com) for information on global distributors and representatives.

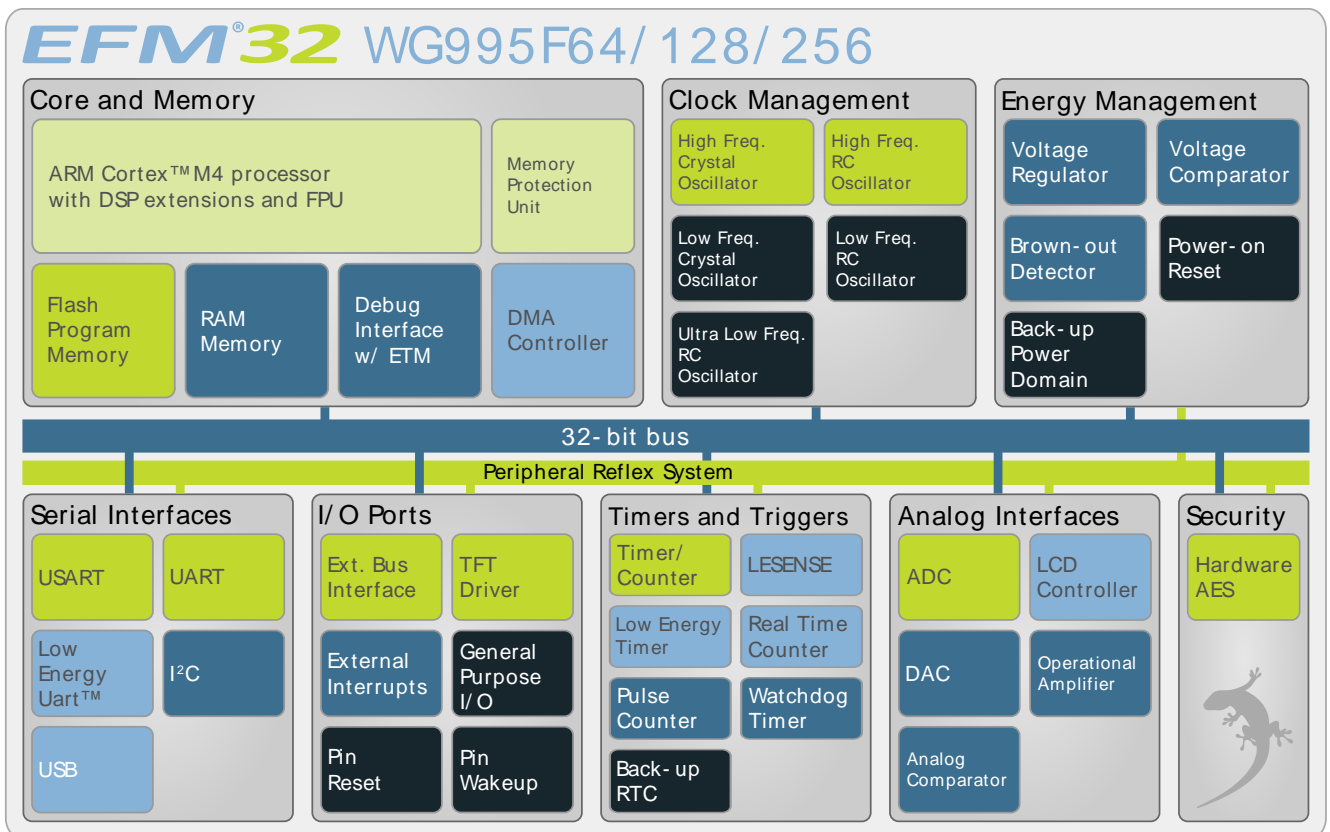
## 2 System Summary

### 2.1 System Introduction

The EFM32 MCUs are the world's most energy friendly microcontrollers. With a unique combination of the powerful 32-bit ARM Cortex-M4, with DSP instruction support and floating-point unit, innovative low energy techniques, short wake-up time from energy saving modes, and a wide selection of peripherals, the EFM32WG microcontroller is well suited for any battery operated application as well as other systems requiring high performance and low-energy consumption. This section gives a short introduction to each of the modules in general terms and also shows a summary of the configuration for the EFM32WG995 devices. For a complete feature set and in-depth information on the modules, the reader is referred to the *EFM32WG Reference Manual*.

A block diagram of the EFM32WG995 is shown in Figure 2.1 (p. 3) .

**Figure 2.1. Block Diagram**



#### 2.1.1 ARM Cortex-M4 Core

The ARM Cortex-M4 includes a 32-bit RISC processor, with DSP instruction support and floating-point unit, which can achieve as much as 1.25 Dhrystone MIPS/MHz. A Memory Protection Unit with support for up to 8 memory segments is included, as well as a Wake-up Interrupt Controller handling interrupts triggered while the CPU is asleep. The EFM32 implementation of the Cortex-M4 is described in detail in *ARM Cortex-M4 Devices Generic User Guide*.

#### 2.1.2 Debug Interface (DBG)

This device includes hardware debug support through a 2-pin serial-wire debug interface and an Embedded Trace Module (ETM) for data/instruction tracing. In addition there is also a 1-wire Serial Wire Viewer pin which can be used to output profiling information, data trace and software-generated messages.

### 2.1.3 Memory System Controller (MSC)

The Memory System Controller (MSC) is the program memory unit of the EFM32WG microcontroller. The flash memory is readable and writable from both the Cortex-M4 and DMA. The flash memory is divided into two blocks; the main block and the information block. Program code is normally written to the main block. Additionally, the information block is available for special user data and flash lock bits. There is also a read-only page in the information block containing system and device calibration data. Read and write operations are supported in the energy modes EM0 and EM1.

### 2.1.4 Direct Memory Access Controller (DMA)

The Direct Memory Access (DMA) controller performs memory operations independently of the CPU. This has the benefit of reducing the energy consumption and the workload of the CPU, and enables the system to stay in low energy modes when moving for instance data from the USART to RAM or from the External Bus Interface to a PWM-generating timer. The DMA controller uses the PL230  $\mu$ DMA controller licensed from ARM.

### 2.1.5 Reset Management Unit (RMU)

The RMU is responsible for handling the reset functionality of the EFM32WG.

### 2.1.6 Energy Management Unit (EMU)

The Energy Management Unit (EMU) manage all the low energy modes (EM) in EFM32WG microcontrollers. Each energy mode manages if the CPU and the various peripherals are available. The EMU can also be used to turn off the power to unused SRAM blocks.

### 2.1.7 Clock Management Unit (CMU)

The Clock Management Unit (CMU) is responsible for controlling the oscillators and clocks on-board the EFM32WG. The CMU provides the capability to turn on and off the clock on an individual basis to all peripheral modules in addition to enable/disable and configure the available oscillators. The high degree of flexibility enables software to minimize energy consumption in any specific application by not wasting power on peripherals and oscillators that are inactive.

### 2.1.8 Watchdog (WDOG)

The purpose of the watchdog timer is to generate a reset in case of a system failure, to increase application reliability. The failure may e.g. be caused by an external event, such as an ESD pulse, or by a software failure.

### 2.1.9 Peripheral Reflex System (PRS)

The Peripheral Reflex System (PRS) system is a network which lets the different peripheral module communicate directly with each other without involving the CPU. Peripheral modules which send out Reflex signals are called producers. The PRS routes these reflex signals to consumer peripherals which apply actions depending on the data received. The format for the Reflex signals is not given, but edge triggers and other functionality can be applied by the PRS.

### 2.1.10 External Bus Interface (EBI)

The External Bus Interface provides access to external parallel interface devices such as SRAM, FLASH, ADCs and LCDs. The interface is memory mapped into the address bus of the Cortex-M4. This enables seamless access from software without manually manipulating the IO settings each time a read or write is performed. The data and address lines are multiplexed in order to reduce the number of pins required to interface the external devices. The timing is adjustable to meet specifications of the external devices. The interface is limited to asynchronous devices.

### 2.1.11 TFT Direct Drive

The EBI contains a TFT controller which can drive a TFT via a 565 RGB interface. The TFT controller supports programmable display and port sizes and offers accurate control of frequency and setup and hold timing. Direct Drive is supported for TFT displays which do not have their own frame buffer. In that case TFT Direct Drive can transfer data from either on-chip memory or from an external memory device to the TFT at low CPU load. Automatic alpha-blending and masking is also supported for transfers through the EBI interface.

### 2.1.12 Universal Serial Bus Controller (USB)

The USB is a full-speed USB 2.0 compliant OTG host/device controller. The USB can be used in Device, On-the-go (OTG) Dual Role Device or Host-only configuration. In OTG mode the USB supports both Host Negotiation Protocol (HNP) and Session Request Protocol (SRP). The device supports both full-speed (12MBit/s) and low speed (1.5MBit/s) operation. The USB device includes an internal dedicated Descriptor-Based Scatter/Gather DMA and supports up to 6 OUT endpoints and 6 IN endpoints, in addition to endpoint 0. The on-chip PHY includes all OTG features, except for the voltage booster for supplying 5V to VBUS when operating as host.

### 2.1.13 Inter-Integrated Circuit Interface (I2C)

The I<sup>2</sup>C module provides an interface between the MCU and a serial I<sup>2</sup>C-bus. It is capable of acting as both a master and a slave, and supports multi-master buses. Both standard-mode, fast-mode and fast-mode plus speeds are supported, allowing transmission rates all the way from 10 kbit/s up to 1 Mbit/s. Slave arbitration and timeouts are also provided to allow implementation of an SMBus compliant system. The interface provided to software by the I<sup>2</sup>C module, allows both fine-grained control of the transmission process and close to automatic transfers. Automatic recognition of slave addresses is provided in all energy modes.

### 2.1.14 Universal Synchronous/Asynchronous Receiver/Transmitter (USART)

The Universal Synchronous Asynchronous serial Receiver and Transmitter (USART) is a very flexible serial I/O module. It supports full duplex asynchronous UART communication as well as RS-485, SPI, MicroWire and 3-wire. It can also interface with ISO7816 SmartCards, IrDA and I2S devices.

### 2.1.15 Pre-Programmed USB/UART Bootloader

The bootloader presented in application note AN0042 is pre-programmed in the device at factory. The bootloader enables users to program the EFM32 through a UART or a USB CDC class virtual UART without the need for a debugger. The autobaud feature, interface and commands are described further in the application note.

### 2.1.16 Universal Asynchronous Receiver/Transmitter (UART)

The Universal Asynchronous serial Receiver and Transmitter (UART) is a very flexible serial I/O module. It supports full- and half-duplex asynchronous UART communication.

### 2.1.17 Low Energy Universal Asynchronous Receiver/Transmitter (LEUART)

The unique LEUART<sup>™</sup>, the Low Energy UART, is a UART that allows two-way UART communication on a strict power budget. Only a 32.768 kHz clock is needed to allow UART communication up to 9600 baud/s. The LEUART includes all necessary hardware support to make asynchronous serial communication possible with minimum of software intervention and energy consumption.

### 2.1.18 Timer/Counter (TIMER)

The 16-bit general purpose Timer has 3 compare/capture channels for input capture and compare/Pulse-Width Modulation (PWM) output. TIMER0 also includes a Dead-Time Insertion module suitable for motor control applications.

### 2.1.19 Real Time Counter (RTC)

The Real Time Counter (RTC) contains a 24-bit counter and is clocked either by a 32.768 kHz crystal oscillator, or a 32.768 kHz RC oscillator. In addition to energy modes EM0 and EM1, the RTC is also available in EM2. This makes it ideal for keeping track of time since the RTC is enabled in EM2 where most of the device is powered down.

### 2.1.20 Backup Real Time Counter (BURTC)

The Backup Real Time Counter (BURTC) contains a 32-bit counter and is clocked either by a 32.768 kHz crystal oscillator, a 32.768 kHz RC oscillator or a 1 kHz ULFRCO. The BURTC is available in all Energy Modes and it can also run in backup mode, making it operational even if the main power should drain out.

### 2.1.21 Low Energy Timer (LETIMER)

The unique LETIMER<sup>™</sup>, the Low Energy Timer, is a 16-bit timer that is available in energy mode EM2 in addition to EM1 and EM0. Because of this, it can be used for timing and output generation when most of the device is powered down, allowing simple tasks to be performed while the power consumption of the system is kept at an absolute minimum. The LETIMER can be used to output a variety of waveforms with minimal software intervention. It is also connected to the Real Time Counter (RTC), and can be configured to start counting on compare matches from the RTC.

### 2.1.22 Pulse Counter (PCNT)

The Pulse Counter (PCNT) can be used for counting pulses on a single input or to decode quadrature encoded inputs. It runs off either the internal LFACLK or the PCNTn\_S0IN pin as external clock source. The module may operate in energy mode EM0 – EM3.

### 2.1.23 Analog Comparator (ACMP)

The Analog Comparator is used to compare the voltage of two analog inputs, with a digital output indicating which input voltage is higher. Inputs can either be one of the selectable internal references or from external pins. Response time and thereby also the current consumption can be configured by altering the current supply to the comparator.

### 2.1.24 Voltage Comparator (VCMP)

The Voltage Supply Comparator is used to monitor the supply voltage from software. An interrupt can be generated when the supply falls below or rises above a programmable threshold. Response time and thereby also the current consumption can be configured by altering the current supply to the comparator.

### 2.1.25 Analog to Digital Converter (ADC)

The ADC is a Successive Approximation Register (SAR) architecture, with a resolution of up to 12 bits at up to one million samples per second. The integrated input mux can select inputs from 8 external pins and 6 internal signals.

### 2.1.26 Digital to Analog Converter (DAC)

The Digital to Analog Converter (DAC) can convert a digital value to an analog output voltage. The DAC is fully differential rail-to-rail, with 12-bit resolution. It has two single ended output buffers which can be combined into one differential output. The DAC may be used for a number of different applications such as sensor interfaces or sound output.



### 2.1.27 Operational Amplifier (OPAMP)

The EFM32WG995 features 3 Operational Amplifiers. The Operational Amplifier is a versatile general purpose amplifier with rail-to-rail differential input and rail-to-rail single ended output. The input can be set to pin, DAC or OPAMP, whereas the output can be pin, OPAMP or ADC. The current is programmable and the OPAMP has various internal configurations such as unity gain, programmable gain using internal resistors etc.

### 2.1.28 Low Energy Sensor Interface (LESENSE)

The Low Energy Sensor Interface (LESENSE<sup>™</sup>), is a highly configurable sensor interface with support for up to 16 individually configurable sensors. By controlling the analog comparators and DAC, LESENSE is capable of supporting a wide range of sensors and measurement schemes, and can for instance measure LC sensors, resistive sensors and capacitive sensors. LESENSE also includes a programmable FSM which enables simple processing of measurement results without CPU intervention. LESENSE is available in energy mode EM2, in addition to EM0 and EM1, making it ideal for sensor monitoring in applications with a strict energy budget.

### 2.1.29 Backup Power Domain

The backup power domain is a separate power domain containing a Backup Real Time Counter, BURTC, and a set of retention registers, available in all energy modes. This power domain can be configured to automatically change power source to a backup battery when the main power drains out. The backup power domain enables the EFM32WG995 to keep track of time and retain data, even if the main power source should drain out.

### 2.1.30 Advanced Encryption Standard Accelerator (AES)

The AES accelerator performs AES encryption and decryption with 128-bit or 256-bit keys. Encrypting or decrypting one 128-bit data block takes 52 HFCORECLK cycles with 128-bit keys and 75 HFCORECLK cycles with 256-bit keys. The AES module is an AHB slave which enables efficient access to the data and key registers. All write accesses to the AES module must be 32-bit operations, i.e. 8- or 16-bit operations are not supported.

### 2.1.31 General Purpose Input/Output (GPIO)

In the EFM32WG995, there are 93 General Purpose Input/Output (GPIO) pins, which are divided into ports with up to 16 pins each. These pins can individually be configured as either an output or input. More advanced configurations like open-drain, filtering and drive strength can also be configured individually for the pins. The GPIO pins can also be overridden by peripheral pin connections, like Timer PWM outputs or USART communication, which can be routed to several locations on the device. The GPIO supports up to 16 asynchronous external pin interrupts, which enables interrupts from any pin on the device. Also, the input value of a pin can be routed through the Peripheral Reflex System to other peripherals.

### 2.1.32 Liquid Crystal Display Driver (LCD)

The LCD driver is capable of driving a segmented LCD display with up to 8x36 segments. A voltage boost function enables it to provide the LCD display with higher voltage than the supply voltage for the device. In addition, an animation feature can run custom animations on the LCD display without any CPU intervention. The LCD driver can also remain active even in Energy Mode 2 and provides a Frame Counter interrupt that can wake-up the device on a regular basis for updating data.

## 2.2 Configuration Summary

The features of the EFM32WG995 is a subset of the feature set described in the EFM32WG Reference Manual. Table 2.1 (p. 8) describes device specific implementation of the features.

**Table 2.1. Configuration Summary**

| Module    | Configuration                             | Pin Connections   |
|-----------|---|---|
| Cortex-M4 | Full configuration                        | NA  |
| DBG       | Full configuration                        | DBG_SWCLK, DBG_SWDIO, DBG_SWO   |
| MSC       | Full configuration                        | NA  |
| DMA       | Full configuration                        | NA  |
| RMU       | Full configuration                        | NA  |
| EMU       | Full configuration                        | NA  |
| CMU       | Full configuration                        | CMU_OUT0, CMU_OUT1  |
| WDOG      | Full configuration                        | NA  |
| PRS       | Full configuration                        | NA  |
| USB       | Full configuration                        | USB_VBUS, USB_VBUSEN, USB_VREGI, USB_VREGO, USB_DM, USB_DMPU, USB_DP, USB_ID  |
| EBI       | Full configuration                        | EBI_A[27:0], EBI_AD[15:0], EBI_ARDY, EBI_ALE, EBI_BL[1:0], EBI_CS[3:0], EBI_CSTFT, EBI_DCLK, EBI_DTEN, EBI_HSNC, EBI_NANDREn, EBI_NANDWEn, EBI_REn, EBI_VSNC, EBI_WEn |
| I2C0      | Full configuration                        | I2C0_SDA, I2C0_SCL  |
| I2C1      | Full configuration                        | I2C1_SDA, I2C1_SCL  |
| USART0    | Full configuration with IrDA              | US0_TX, US0_RX, US0_CLK, US0_CS   |
| USART1    | Full configuration with I2S               | US1_TX, US1_RX, US1_CLK, US1_CS   |
| USART2    | Full configuration with I2S               | US2_TX, US2_RX, US2_CLK, US2_CS   |
| UART0     | Full configuration                        | U0_TX, U0_RX  |
| UART1     | Full configuration                        | U1_TX, U1_RX  |
| LEUART0   | Full configuration                        | LEU0_TX, LEU0_RX  |
| LEUART1   | Full configuration                        | LEU1_TX, LEU1_RX  |
| TIMER0    | Full configuration with DTI               | TIM0_CC[2:0], TIM0_CDTI[2:0]  |
| TIMER1    | Full configuration                        | TIM1_CC[2:0]  |
| TIMER2    | Full configuration                        | TIM2_CC[2:0]  |
| TIMER3    | Full configuration                        | TIM3_CC[2:0]  |
| RTC       | Full configuration                        | NA  |
| BURTC     | Full configuration                        | NA  |
| LETIMER0  | Full configuration                        | LET0_O[1:0]   |
| PCNT0     | Full configuration, 16-bit count register | PCNT0_S[1:0]  |
| PCNT1     | Full configuration, 8-bit count register  | PCNT1_S[1:0]  |
| PCNT2     | Full configuration, 8-bit count register  | PCNT2_S[1:0]  |
| ACMP0     | Full configuration                        | ACMP0_CH[7:0], ACMP0_O  |
| ACMP1     | Full configuration                        | ACMP1_CH[7:0], ACMP1_O  |

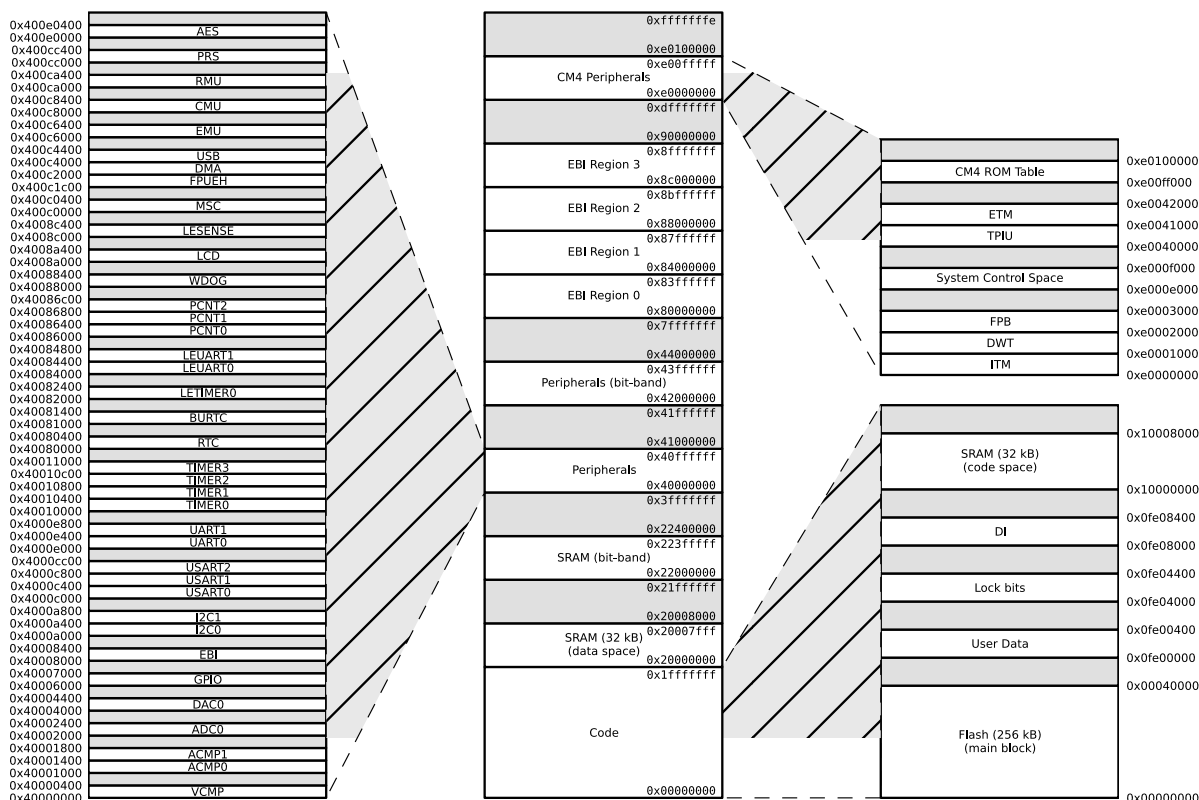


| Module | Configuration      | Pin Connections  |
|--------|--------------------|--|
| VCMP   | Full configuration | NA   |
| ADC0   | Full configuration | ADC0_CH[7:0]   |
| DAC0   | Full configuration | DAC0_OUT[1:0], DAC0_OUTxALT                                    |
| OPAMP  | Full configuration | Outputs: OPAMP_OUTx, OPAMP_OUTxALT, Inputs: OPAMP_Px, OPAMP_Nx |
| AES    | Full configuration | NA   |
| GPIO   | 93 pins            | Available pins are shown in Table 4.3 (p. 66)                  |
| LCD    | Full configuration | LCD_SEG[35:0], LCD_COM[7:0], LCD_BCAP_P, LCD_BCAP_N, LCD_BEXT  |

## 2.3 Memory Map

The EFM32WG995 memory map is shown in Figure 2.2 (p. 9), with RAM and Flash sizes for the largest memory configuration.

Figure 2.2. EFM32WG995 Memory Map with largest RAM and Flash sizes



## 3 Electrical Characteristics

### 3.1 Test Conditions

#### 3.1.1 Typical Values

The typical data are based on  $T_{AMB}=25^{\circ}\text{C}$  and  $V_{DD}=3.0\text{ V}$ , as defined in Table 3.2 (p. 10), by simulation and/or technology characterisation unless otherwise specified.

#### 3.1.2 Minimum and Maximum Values

The minimum and maximum values represent the worst conditions of ambient temperature, supply voltage and frequencies, as defined in Table 3.2 (p. 10), by simulation and/or technology characterisation unless otherwise specified.

### 3.2 Absolute Maximum Ratings

The absolute maximum ratings are stress ratings, and functional operation under such conditions are not guaranteed. Stress beyond the limits specified in Table 3.1 (p. 10) may affect the device reliability or cause permanent damage to the device. Functional operating conditions are given in Table 3.2 (p. 10).

**Table 3.1. Absolute Maximum Ratings**

| Symbol      | Parameter                     | Condition                           | Min  | Typ | Max              | Unit               |
|-------------|-------------------------------|-------------------------------------|------|-----|------------------|--------------------|
| $T_{STG}$   | Storage temperature range     |                                     | -40  |     | 150 <sup>1</sup> | $^{\circ}\text{C}$ |
| $T_S$       | Maximum soldering temperature | Latest IPC/JEDEC J-STD-020 Standard |      |     | 260              | $^{\circ}\text{C}$ |
| $V_{DDMAX}$ | External main supply voltage  |                                     | 0    |     | 3.8              | V                  |
| $V_{IOPIN}$ | Voltage on any I/O pin        |                                     | -0.3 |     | $V_{DD}+0.3$     | V                  |

<sup>1</sup>Based on programmed devices tested for 10000 hours at 150 $^{\circ}\text{C}$ . Storage temperature affects retention of preprogrammed calibration values stored in flash. Please refer to the Flash section in the Electrical Characteristics for information on flash data retention for different temperatures.

### 3.3 General Operating Conditions

#### 3.3.1 General Operating Conditions

**Table 3.2. General Operating Conditions**

| Symbol     | Parameter                    | Min  | Typ | Max | Unit               |
|------------|------------------------------|------|-----|-----|--------------------|
| $T_{AMB}$  | Ambient temperature range    | -40  |     | 85  | $^{\circ}\text{C}$ |
| $V_{DDOP}$ | Operating supply voltage     | 1.85 |     | 3.8 | V                  |
| $f_{APB}$  | Internal APB clock frequency |      |     | 48  | MHz                |
| $f_{AHB}$  | Internal AHB clock frequency |      |     | 48  | MHz                |

### 3.3.2 Environmental

**Table 3.3. Environmental**

| Symbol              | Parameter                       | Condition              | Min | Typ | Max  | Unit |
|---------------------|---------------------------------|------------------------|-----|-----|------|------|
| V <sub>ESDHBM</sub> | ESD (Human Body Model HBM)      | T <sub>AMB</sub> =25°C |     |     | 2500 | V    |
| V <sub>ESDCDM</sub> | ESD (Charged Device Model, CDM) | T <sub>AMB</sub> =25°C |     |     | 500  | V    |

Latch-up sensitivity passed:  $\pm 100 \text{ mA}/1.5 \times V_{\text{SUPPLY}}(\text{max})$  according to JEDEC JESD 78 method Class II, 85°C.

### 3.4 Current Consumption

**Table 3.4. Current Consumption**

| Symbol           | Parameter   | Condition  | Min | Typ   | Max | Unit   |
|------------------|---|--|-----|-------|-----|--------|
| I <sub>EM0</sub> | EM0 current. No prescaling. Running prime number calculation code from Flash. | 48 MHz HFXO, all peripheral clocks disabled, V <sub>DD</sub> = 3.0 V, T <sub>AMB</sub> =25°C   |     | 224.8 |     | μA/MHz |
|                  |   | 48 MHz HFXO, all peripheral clocks disabled, V <sub>DD</sub> = 3.0 V, T <sub>AMB</sub> =85°C   |     | 224.6 |     | μA/MHz |
|                  |   | 28 MHz HFRCO, all peripheral clocks disabled, V <sub>DD</sub> = 3.0 V, T <sub>AMB</sub> =25°C  |     | 226.1 |     | μA/MHz |
|                  |   | 28 MHz HFRCO, all peripheral clocks disabled, V <sub>DD</sub> = 3.0 V, T <sub>AMB</sub> =85°C  |     | 227.1 |     | μA/MHz |
|                  |   | 21 MHz HFRCO, all peripheral clocks disabled, V <sub>DD</sub> = 3.0 V, T <sub>AMB</sub> =25°C  |     | 228.0 |     | μA/MHz |
|                  |   | 21 MHz HFRCO, all peripheral clocks disabled, V <sub>DD</sub> = 3.0 V, T <sub>AMB</sub> =85°C  |     | 229.0 |     | μA/MHz |
|                  |   | 14 MHz HFRCO, all peripheral clocks disabled, V <sub>DD</sub> = 3.0 V, T <sub>AMB</sub> =25°C  |     | 230.4 |     | μA/MHz |
|                  |   | 14 MHz HFRCO, all peripheral clocks disabled, V <sub>DD</sub> = 3.0 V, T <sub>AMB</sub> =85°C  |     | 231.3 |     | μA/MHz |
|                  |   | 11 MHz HFRCO, all peripheral clocks disabled, V <sub>DD</sub> = 3.0 V, T <sub>AMB</sub> =25°C  |     | 232.3 |     | μA/MHz |
|                  |   | 11 MHz HFRCO, all peripheral clocks disabled, V <sub>DD</sub> = 3.0 V, T <sub>AMB</sub> =85°C  |     | 233.2 |     | μA/MHz |
|                  |   | 6.6 MHz HFRCO, all peripheral clocks disabled, V <sub>DD</sub> = 3.0 V, T <sub>AMB</sub> =25°C |     | 237.5 |     | μA/MHz |
|                  |   | 6.6 MHz HFRCO, all peripheral clocks disabled, V <sub>DD</sub> = 3.0 V, T <sub>AMB</sub> =85°C |     | 237.6 |     | μA/MHz |

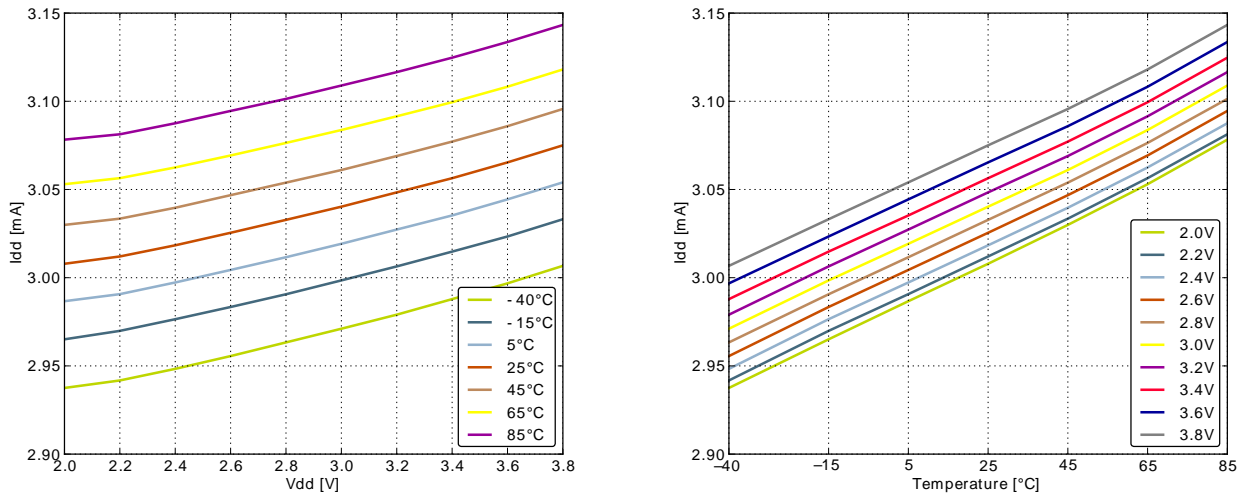
| Symbol           | Parameter   | Condition  | Min         | Typ   | Max | Unit              |
|------------------|-------------|--|-------------|---|-----|-------------------|
|                  |             | 1.2 MHz HFRCO, all peripheral clocks disabled, V <sub>DD</sub> = 3.0 V, T <sub>AMB</sub> =25°C |             | 270.6   |     | µA/MHz            |
|                  |             | 1.2 MHz HFRCO, all peripheral clocks disabled, V <sub>DD</sub> = 3.0 V, T <sub>AMB</sub> =85°C |             | 274.9   |     | µA/MHz            |
| I <sub>EM1</sub> | EM1 current | 48 MHz HFXO, all peripheral clocks disabled, V <sub>DD</sub> = 3.0 V, T <sub>AMB</sub> =25°C   |             | 63.3  |     | µA/MHz            |
|                  |             | 48 MHz HFXO, all peripheral clocks disabled, V <sub>DD</sub> = 3.0 V, T <sub>AMB</sub> =85°C   |             | 64.8  |     | µA/MHz            |
|                  |             | 28 MHz HFRCO, all peripheral clocks disabled, V <sub>DD</sub> = 3.0 V, T <sub>AMB</sub> =25°C  |             | 63.6  |     | µA/MHz            |
|                  |             | 28 MHz HFRCO, all peripheral clocks disabled, V <sub>DD</sub> = 3.0 V, T <sub>AMB</sub> =85°C  |             | 65.3  |     | µA/MHz            |
|                  |             | 21 MHz HFRCO, all peripheral clocks disabled, V <sub>DD</sub> = 3.0 V, T <sub>AMB</sub> =25°C  |             | 64.7  |     | µA/MHz            |
|                  |             | 21 MHz HFRCO, all peripheral clocks disabled, V <sub>DD</sub> = 3.0 V, T <sub>AMB</sub> =85°C  |             | 66.3  |     | µA/MHz            |
|                  |             | 14 MHz HFRCO, all peripheral clocks disabled, V <sub>DD</sub> = 3.0 V, T <sub>AMB</sub> =25°C  |             | 66.7  |     | µA/MHz            |
|                  |             | 14 MHz HFRCO, all peripheral clocks disabled, V <sub>DD</sub> = 3.0 V, T <sub>AMB</sub> =85°C  |             | 68.4  |     | µA/MHz            |
|                  |             | 11 MHz HFRCO, all peripheral clocks disabled, V <sub>DD</sub> = 3.0 V, T <sub>AMB</sub> =25°C  |             | 68.4  |     | µA/MHz            |
|                  |             | 11 MHz HFRCO, all peripheral clocks disabled, V <sub>DD</sub> = 3.0 V, T <sub>AMB</sub> =85°C  |             | 70.2  |     | µA/MHz            |
|                  |             | 6.6 MHz HFRCO, all peripheral clocks disabled, V <sub>DD</sub> = 3.0 V, T <sub>AMB</sub> =25°C |             | 73.7  |     | µA/MHz            |
|                  |             | 6.6 MHz HFRCO, all peripheral clocks disabled, V <sub>DD</sub> = 3.0 V, T <sub>AMB</sub> =85°C |             | 75.5  |     | µA/MHz            |
|                  |             | 1.2 MHz HFRCO, all peripheral clocks disabled, V <sub>DD</sub> = 3.0 V, T <sub>AMB</sub> =25°C |             | 106.0   |     | µA/MHz            |
|                  |             | 1.2 MHz HFRCO, all peripheral clocks disabled, V <sub>DD</sub> = 3.0 V, T <sub>AMB</sub> =85°C |             | 111.5   |     | µA/MHz            |
|                  |             | I <sub>EM2</sub>   | EM2 current | EM2 current with RTC prescaled to 1 Hz, 32.768 kHz LFRCO, V <sub>DD</sub> = 3.0 V, T <sub>AMB</sub> =25°C |     | 0.95 <sup>1</sup> |

| Symbol           | Parameter   | Condition   | Min | Typ              | Max | Unit |
|------------------|-------------|---|-----|------------------|-----|------|
|                  |             | EM2 current with RTC prescaled to 1 Hz, 32.768 kHz LFRCO, V <sub>DD</sub> = 3.0 V, T <sub>AMB</sub> =85°C |     | 3.0 <sup>1</sup> |     | µA   |
| I <sub>EM3</sub> | EM3 current | V <sub>DD</sub> = 3.0 V, T <sub>AMB</sub> =25°C   |     | 0.65             |     | µA   |
|                  |             | V <sub>DD</sub> = 3.0 V, T <sub>AMB</sub> =85°C   |     | 2.65             |     | µA   |
| I <sub>EM4</sub> | EM4 current | V <sub>DD</sub> = 3.0 V, T <sub>AMB</sub> =25°C   |     | 0.02             |     | µA   |
|                  |             | V <sub>DD</sub> = 3.0 V, T <sub>AMB</sub> =85°C   |     | 0.44             |     | µA   |

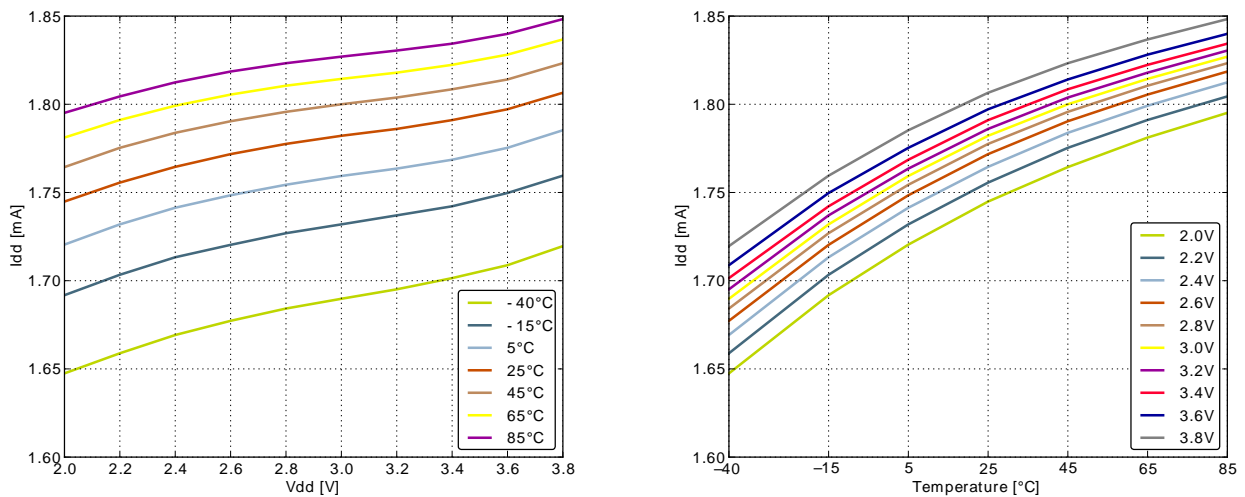
<sup>1</sup>Using backup RTC.

### 3.4.1 EM1 Current Consumption

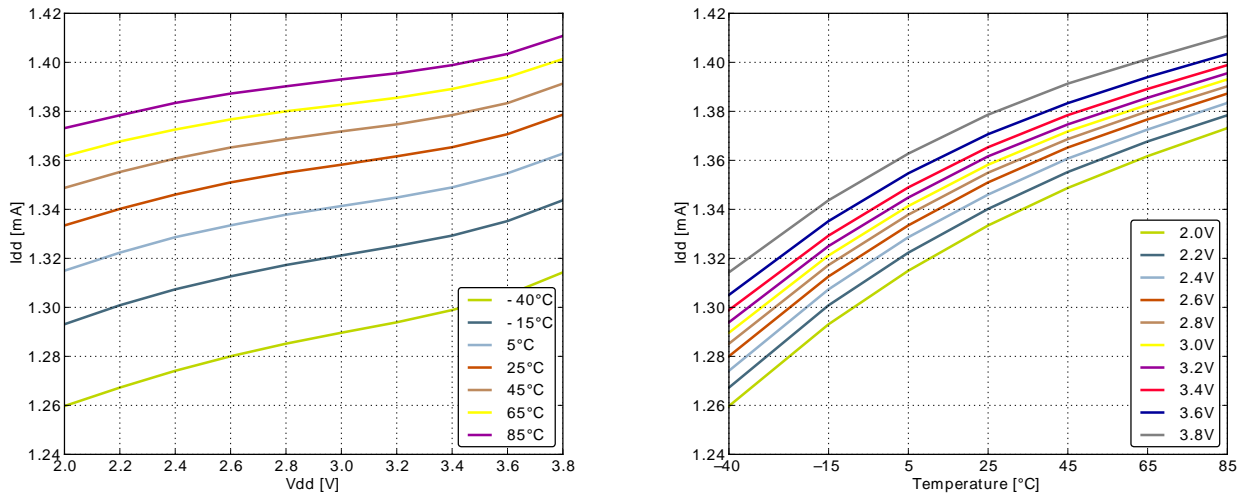
**Figure 3.1. EM1 Current consumption with all peripheral clocks disabled and HFXO running at 48MHz**



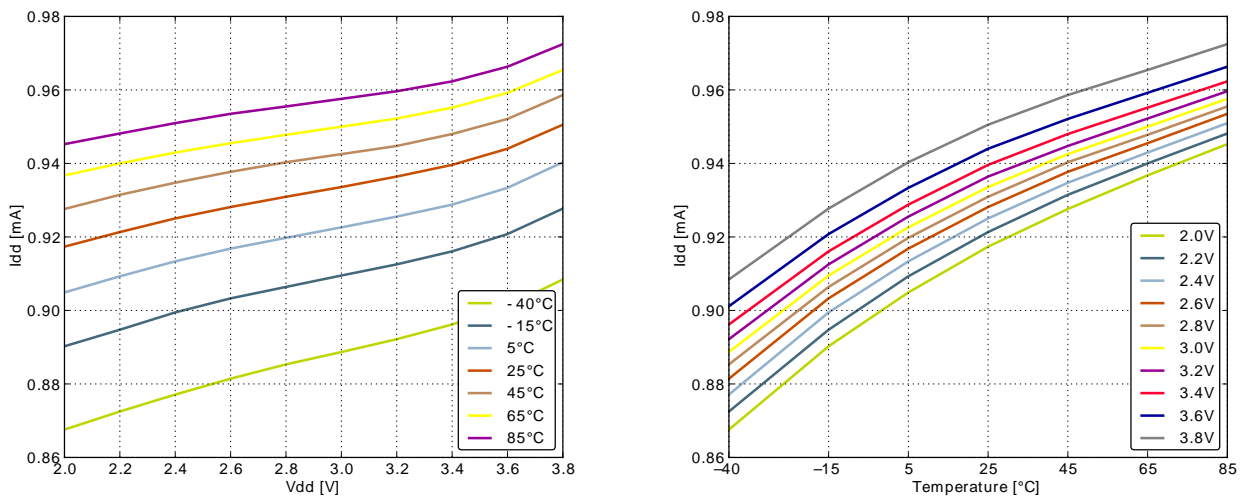
**Figure 3.2. EM1 Current consumption with all peripheral clocks disabled and HFRCO running at 28MHz**



**Figure 3.3. EM1 Current consumption with all peripheral clocks disabled and HFRCO running at 21MHz**

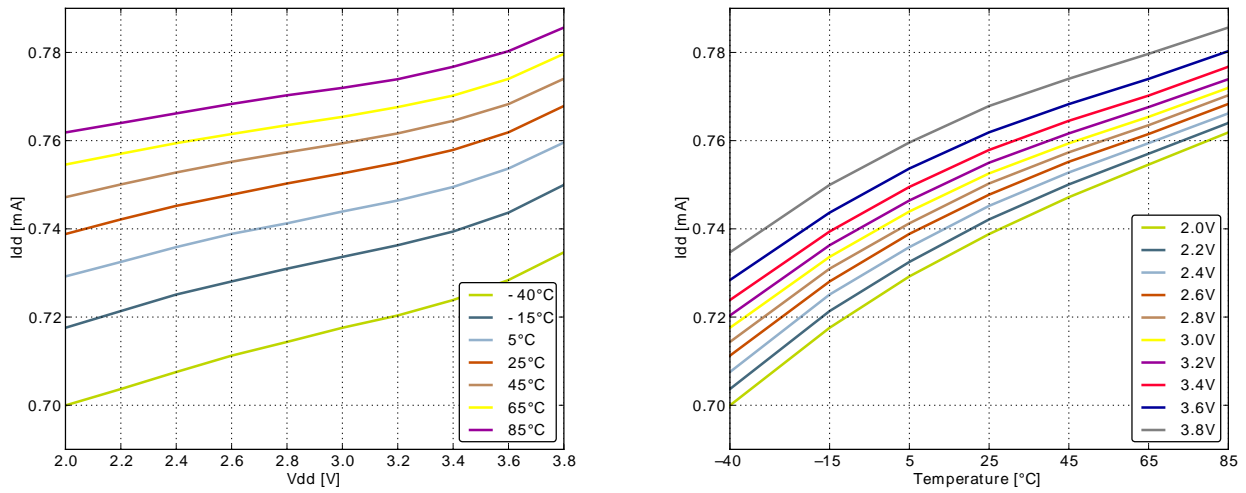


**Figure 3.4. EM1 Current consumption with all peripheral clocks disabled and HFRCO running at 14MHz**

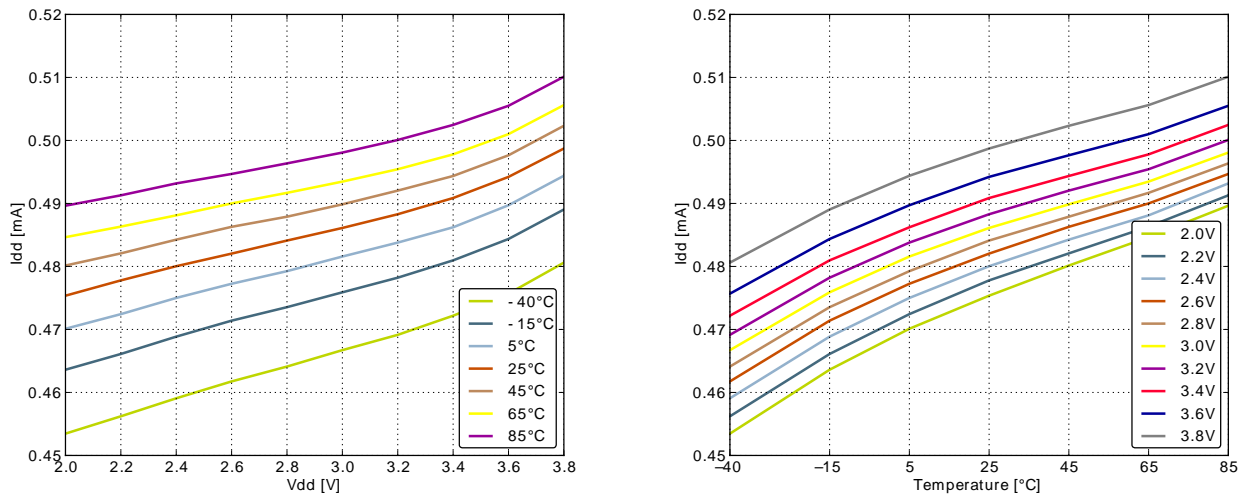




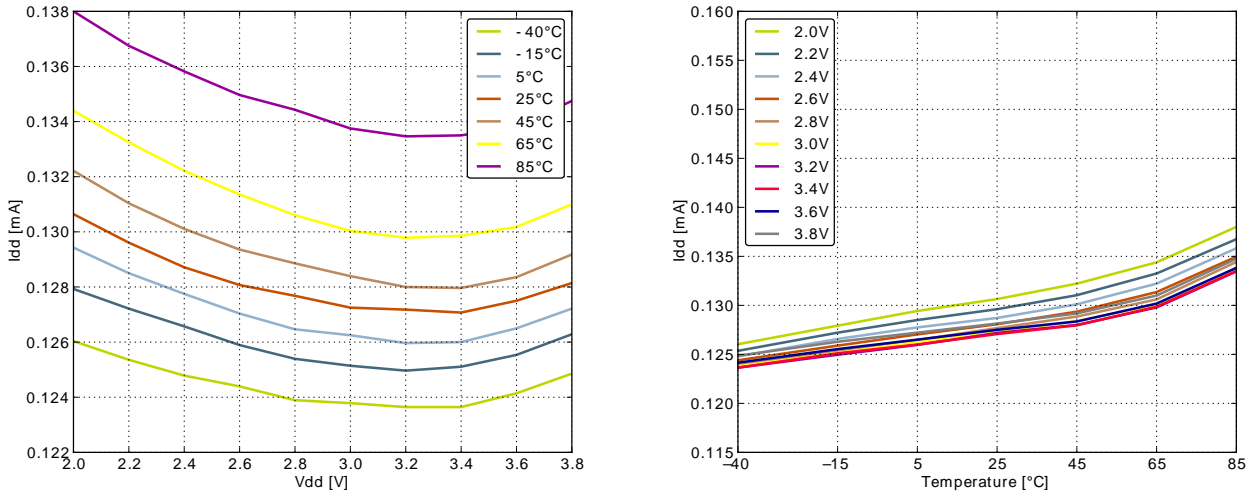
**Figure 3.5. EM1 Current consumption with all peripheral clocks disabled and HFRCO running at 11MHz**



**Figure 3.6. EM1 Current consumption with all peripheral clocks disabled and HFRCO running at 6.6MHz**

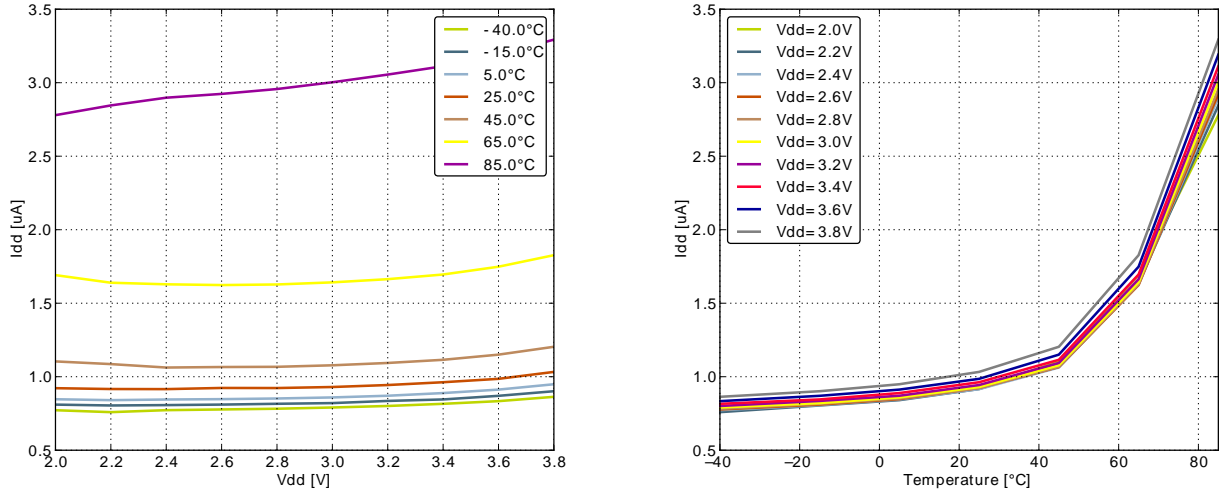


**Figure 3.7. EM1 Current consumption with all peripheral clocks disabled and HFRCO running at 1.2MHz**



### 3.4.2 EM2 Current Consumption

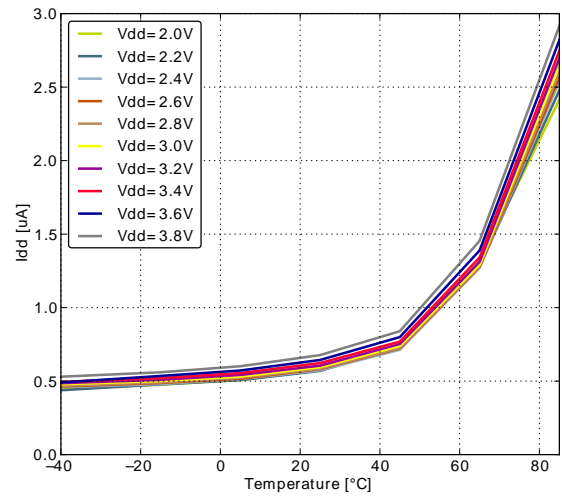
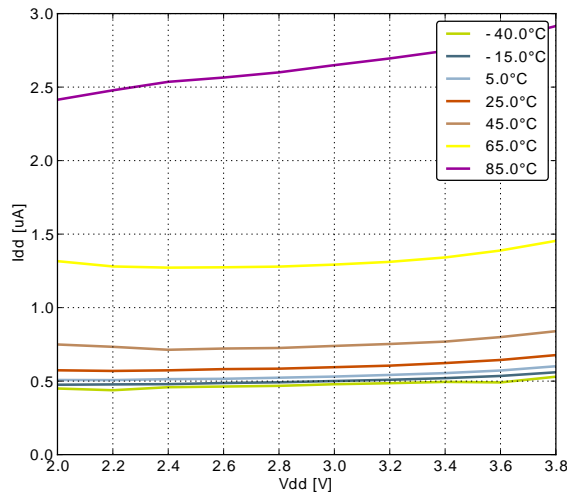
**Figure 3.8. EM2 current consumption. RTC<sup>1</sup> prescaled to 1kHz, 32.768 kHz LFRCO.**



<sup>1</sup>Using backup RTC.

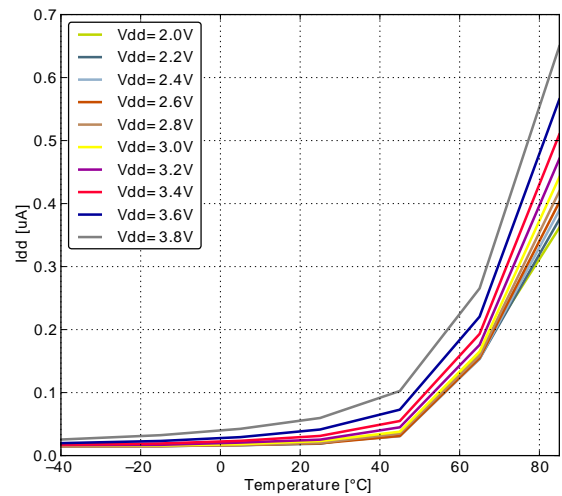
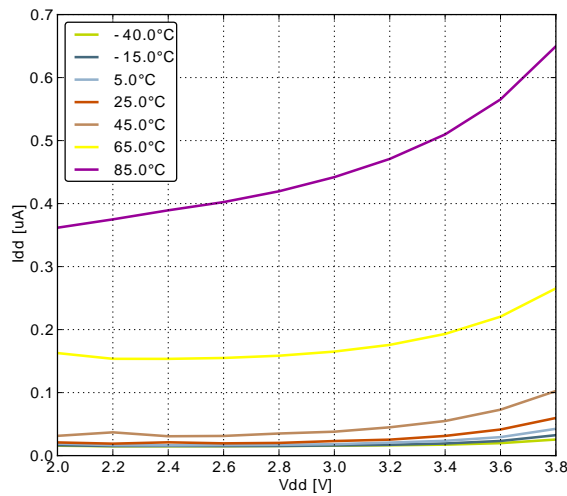
### 3.4.3 EM3 Current Consumption

Figure 3.9. EM3 current consumption.



### 3.4.4 EM4 Current Consumption

Figure 3.10. EM4 current consumption.



## 3.5 Transition between Energy Modes

Table 3.5. Energy Modes Transitions

| Symbol     | Parameter                       | Min | Typ            | Max | Unit               |
|------------|---------------------------------|-----|----------------|-----|--------------------|
| $t_{EM10}$ | Transition time from EM1 to EM0 |     | 0 <sup>1</sup> |     | HF core CLK cycles |
| $t_{EM20}$ | Transition time from EM2 to EM0 |     | 2              |     | $\mu$ s            |
| $t_{EM30}$ | Transition time from EM3 to EM0 |     | 2              |     | $\mu$ s            |
| $t_{EM40}$ | Transition time from EM4 to EM0 |     | 163            |     | $\mu$ s            |

<sup>1</sup>Core wakeup time only.

## 3.6 Power Management

The EFM32WG requires the AVDD\_x, VDD\_DREG and IOVDD\_x pins to be connected together (with optional filter) at the PCB level. For practical schematic recommendations, please see the application note, "AN0002 EFM32 Hardware Design Considerations".

**Table 3.6. Power Management**

| Symbol                  | Parameter  | Condition   | Min  | Typ  | Max  | Unit |
|-------------------------|--|---|------|------|------|------|
| V <sub>BODextthr-</sub> | BOD threshold on falling external supply voltage                 |   | 1.82 |      | 1.85 | V    |
| V <sub>BODintthr-</sub> | BOD threshold on falling internally regulated supply voltage     |   | 1.62 |      | 1.68 | V    |
| V <sub>BODextthr+</sub> | BOD threshold on rising external supply voltage                  |   |      | 1.85 |      | V    |
| V <sub>PORthr+</sub>    | Power-on Reset (POR) threshold on rising external supply voltage |   |      |      | 1.98 | V    |
| t <sub>RESET</sub>      | Delay from reset is released until program execution starts      | Applies to Power-on Reset, Brown-out Reset and pin reset.         |      | 163  |      | μs   |
| C <sub>DECOUPLE</sub>   | Voltage regulator decoupling capacitor.                          | X5R capacitor recommended. Apply between DECOUPLE pin and GROUND  |      | 1    |      | μF   |
| C <sub>USB_VREGO</sub>  | USB voltage regulator out decoupling capacitor.                  | X5R capacitor recommended. Apply between USB_VREGO pin and GROUND |      | 1    |      | μF   |
| C <sub>USB_VREGI</sub>  | USB voltage regulator in decoupling capacitor.                   | X5R capacitor recommended. Apply between USB_VREGI pin and GROUND |      | 4.7  |      | μF   |

## 3.7 Flash

**Table 3.7. Flash**

| Symbol               | Parameter                                   | Condition               | Min   | Typ  | Max            | Unit   |
|----------------------|---|-------------------------|-------|------|----------------|--------|
| EC <sub>FLASH</sub>  | Flash erase cycles before failure           |                         | 20000 |      |                | cycles |
| RET <sub>FLASH</sub> | Flash data retention                        | T <sub>AMB</sub> <150°C | 10000 |      |                | h      |
|                      |   | T <sub>AMB</sub> <85°C  | 10    |      |                | years  |
|                      |   | T <sub>AMB</sub> <70°C  | 20    |      |                | years  |
| t <sub>W_PROG</sub>  | Word (32-bit) programming time              |                         | 20    |      |                | μs     |
| t <sub>PERASE</sub>  | Page erase time                             |                         | 20    | 20.4 | 20.8           | ms     |
| t <sub>DERASE</sub>  | Device erase time                           |                         | 40    | 40.8 | 41.6           | ms     |
| I <sub>ERASE</sub>   | Erase current                               |                         |       |      | 7 <sup>1</sup> | mA     |
| I <sub>WRITE</sub>   | Write current                               |                         |       |      | 7 <sup>1</sup> | mA     |
| V <sub>FLASH</sub>   | Supply voltage during flash erase and write |                         | 1.8   |      | 3.8            | V      |

<sup>1</sup>Measured at 25°C

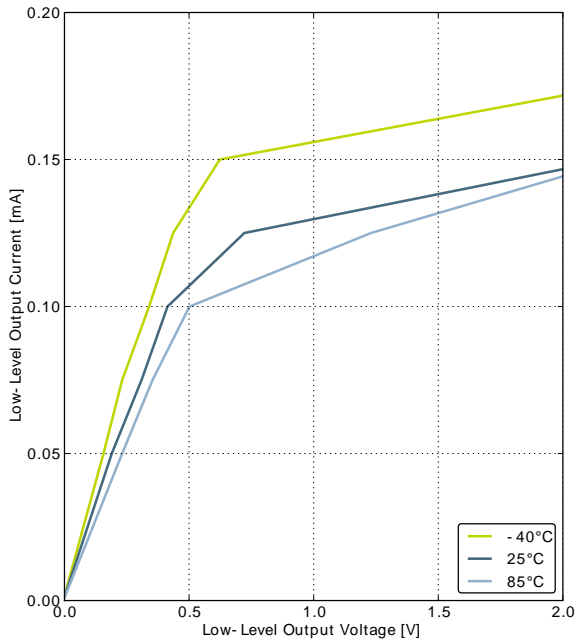
## 3.8 General Purpose Input Output

**Table 3.8. GPIO**

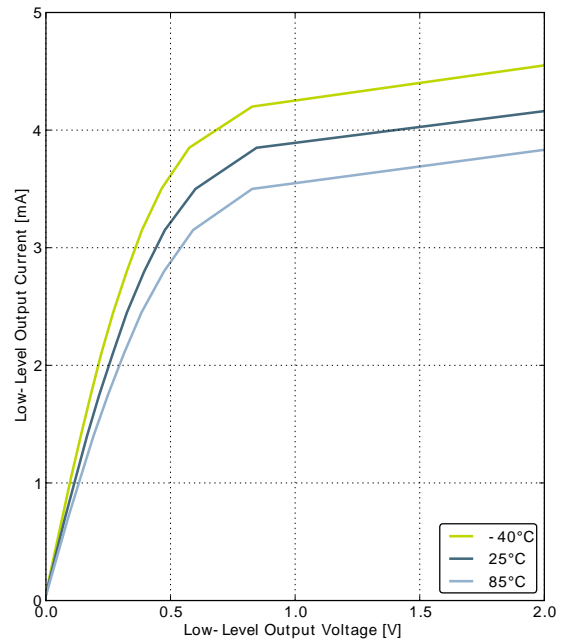
| Symbol                | Parameter  | Condition   | Min                  | Typ | Max                 | Unit |
|-----------------------|--|---|----------------------|-----|---------------------|------|
| V <sub>IOIL</sub>     | Input low voltage  |   |                      |     | 0.3V <sub>DD</sub>  | V    |
| V <sub>IOIH</sub>     | Input high voltage   |   | 0.7V <sub>DD</sub>   |     |                     | V    |
| V <sub>IOOH</sub>     | Output high voltage  | Sourcing 6 mA, V <sub>DD</sub> =1.85 V, GPIO_Px_CTRL DRIVEMODE = STANDARD | 0.75V <sub>DD</sub>  |     |                     | V    |
|                       |  | Sourcing 6 mA, V <sub>DD</sub> =3.0 V, GPIO_Px_CTRL DRIVEMODE = STANDARD  | 0.95V <sub>DD</sub>  |     |                     | V    |
|                       |  | Sourcing 20 mA, V <sub>DD</sub> =1.85 V, GPIO_Px_CTRL DRIVEMODE = HIGH    | 0.7V <sub>DD</sub>   |     |                     | V    |
|                       |  | Sourcing 20 mA, V <sub>DD</sub> =3.0 V, GPIO_Px_CTRL DRIVEMODE = HIGH     | 0.9V <sub>DD</sub>   |     |                     | V    |
| V <sub>IOOL</sub>     | Output low voltage   | Sinking 6 mA, V <sub>DD</sub> =1.85 V, GPIO_Px_CTRL DRIVEMODE = STANDARD  |                      |     | 0.25V <sub>DD</sub> | V    |
|                       |  | Sinking 6 mA, V <sub>DD</sub> =3.0 V, GPIO_Px_CTRL DRIVEMODE = STANDARD   |                      |     | 0.05V <sub>DD</sub> | V    |
|                       |  | Sinking 20 mA, V <sub>DD</sub> =1.85 V, GPIO_Px_CTRL DRIVEMODE = HIGH     |                      |     | 0.3V <sub>DD</sub>  | V    |
|                       |  | Sinking 20 mA, V <sub>DD</sub> =3.0 V, GPIO_Px_CTRL DRIVEMODE = HIGH      |                      |     | 0.1V <sub>DD</sub>  | V    |
| I <sub>IOLEAK</sub>   | Input leakage current  | High Impedance IO connected to GROUND or V <sub>DD</sub>                  |                      |     | +/-25               | nA   |
| R <sub>PU</sub>       | I/O pin pull-up resistor   |   |                      | 40  |                     | kOhm |
| R <sub>PD</sub>       | I/O pin pull-down resistor   |   |                      | 40  |                     | kOhm |
| R <sub>IOESD</sub>    | Internal ESD series resistor   |   |                      | 200 |                     | Ohm  |
| t <sub>IOGLITCH</sub> | Pulse width of pulses to be removed by the glitch suppression filter |   | 10                   |     | 50                  | ns   |
| t <sub>IOOF</sub>     | Output fall time   | 0.5 mA drive strength and load capacitance C <sub>L</sub> =12.5-25pF.     | 20+0.1C <sub>L</sub> |     | 250                 | ns   |
|                       |  | 2mA drive strength and load capacitance C <sub>L</sub> =350-600pF         | 20+0.1C <sub>L</sub> |     | 250                 | ns   |
| V <sub>IOHYST</sub>   | I/O pin hysteresis (V <sub>IOTHR+</sub> - V <sub>IOTHR-</sub> )      | V <sub>DD</sub> = 1.85 - 3.8 V  | 0.1V <sub>DD</sub>   |     |                     | V    |



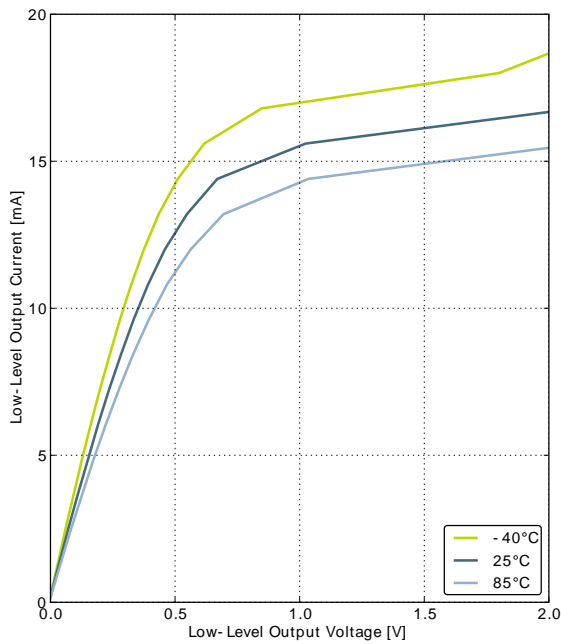
Figure 3.11. Typical Low-Level Output Current, 2V Supply Voltage



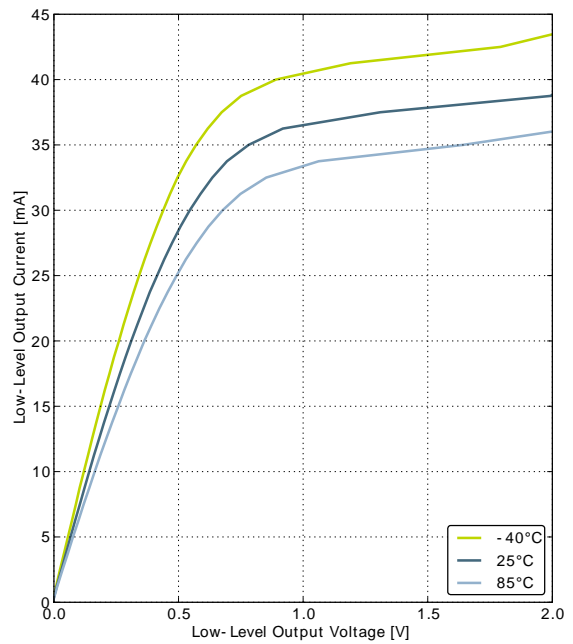
GPIO\_Px\_CTRL DRIVEMODE = LOWEST



GPIO\_Px\_CTRL DRIVEMODE = LOW

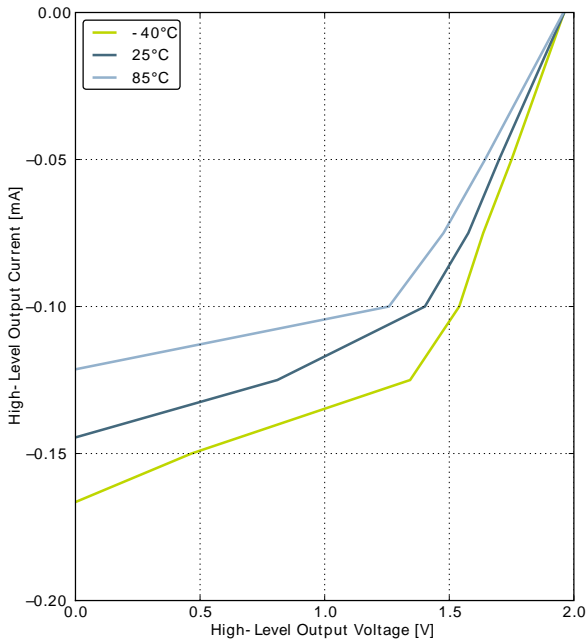


GPIO\_Px\_CTRL DRIVEMODE = STANDARD

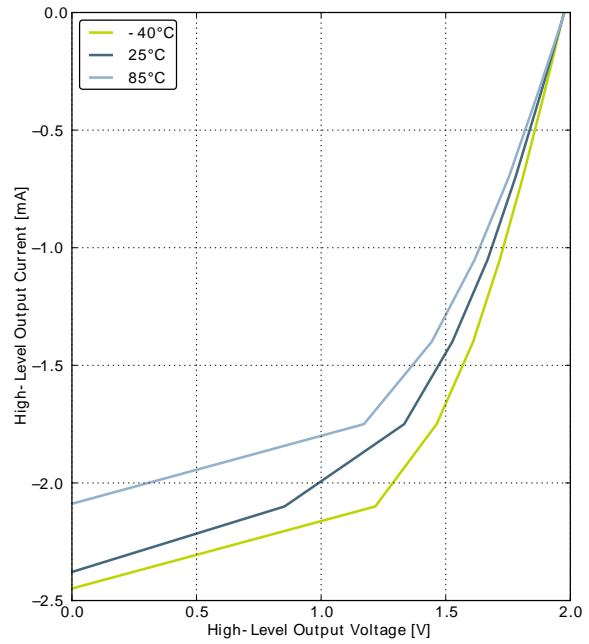


GPIO\_Px\_CTRL DRIVEMODE = HIGH

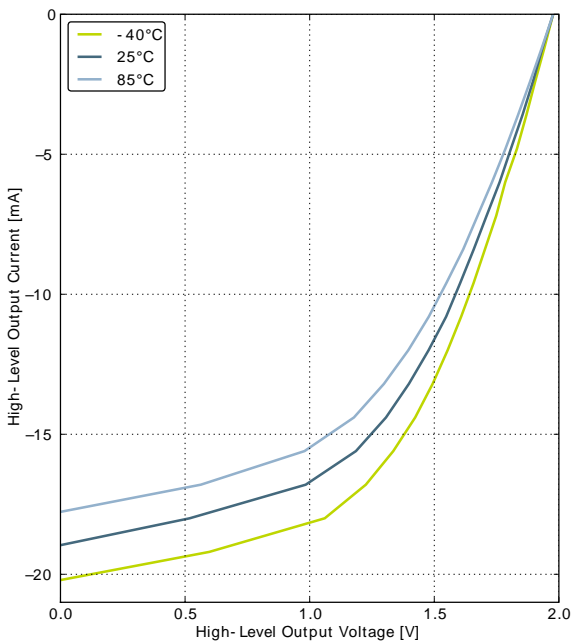
Figure 3.12. Typical High-Level Output Current, 2V Supply Voltage



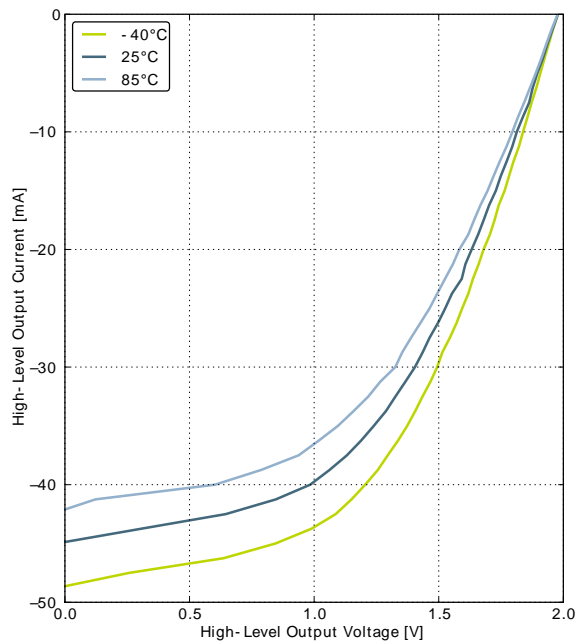
GPIO\_Px\_CTRL DRIVEMODE = LOWEST



GPIO\_Px\_CTRL DRIVEMODE = LOW

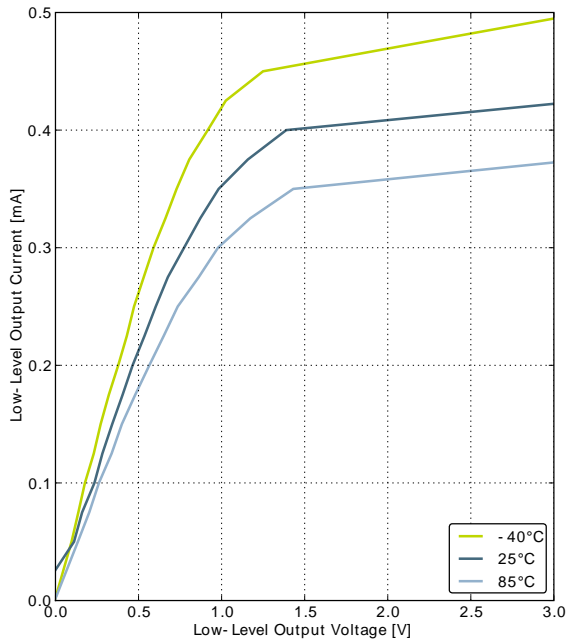


GPIO\_Px\_CTRL DRIVEMODE = STANDARD

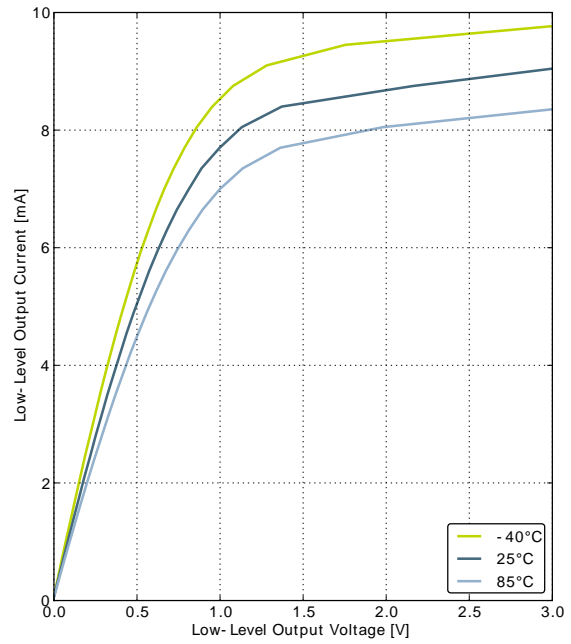


GPIO\_Px\_CTRL DRIVEMODE = HIGH

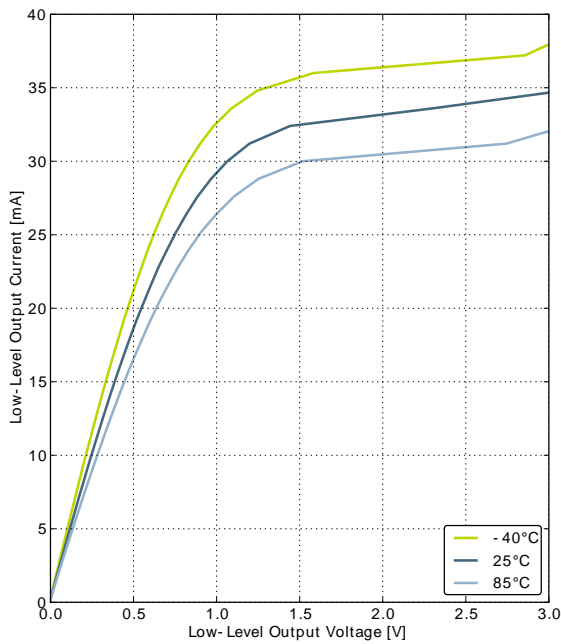
Figure 3.13. Typical Low-Level Output Current, 3V Supply Voltage



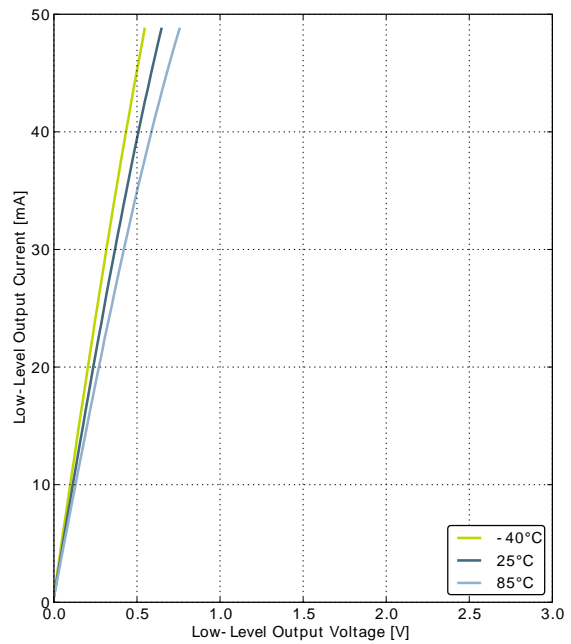
GPIO\_Px\_CTRL DRIVEMODE = LOWEST



GPIO\_Px\_CTRL DRIVEMODE = LOW

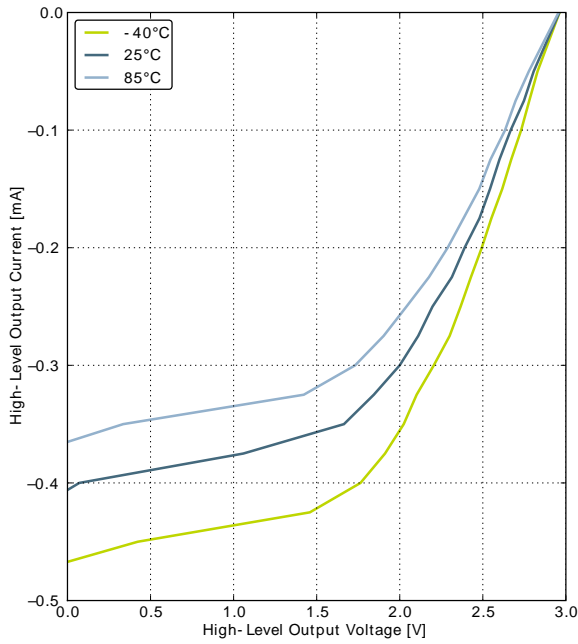


GPIO\_Px\_CTRL DRIVEMODE = STANDARD

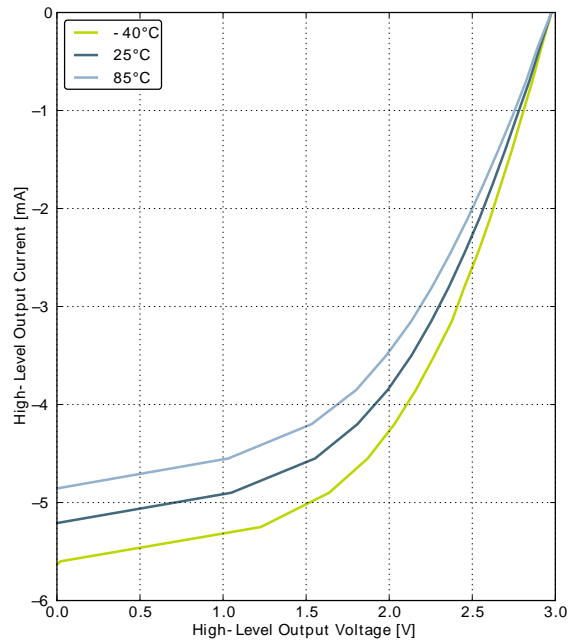


GPIO\_Px\_CTRL DRIVEMODE = HIGH

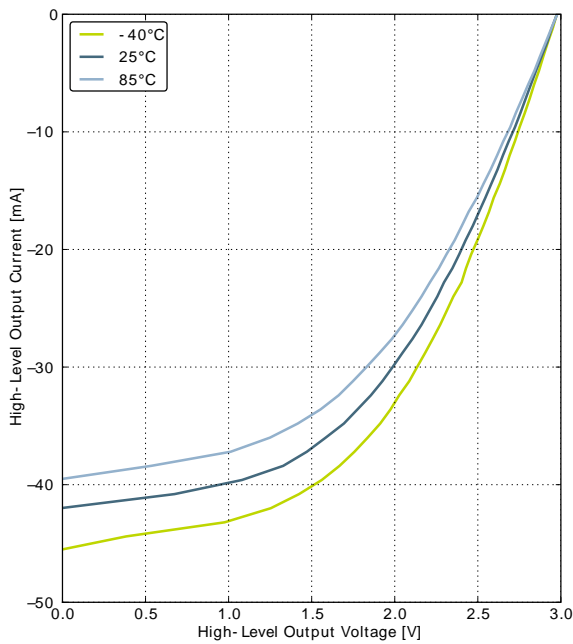
Figure 3.14. Typical High-Level Output Current, 3V Supply Voltage



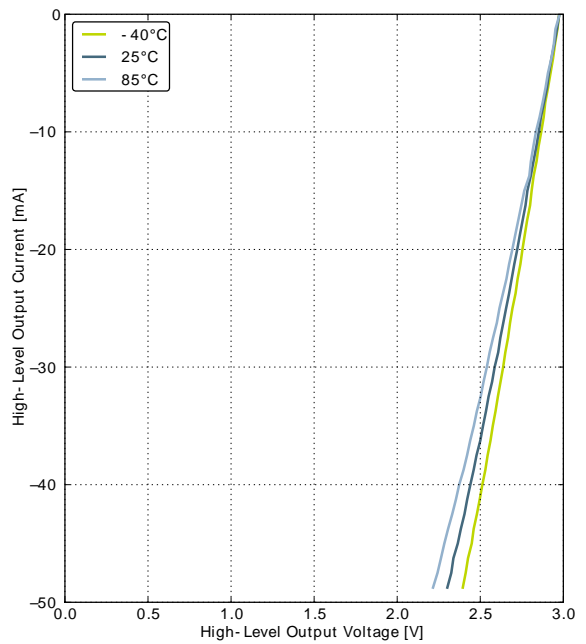
GPIO\_Px\_CTRL DRIVEMODE = LOWEST



GPIO\_Px\_CTRL DRIVEMODE = LOW

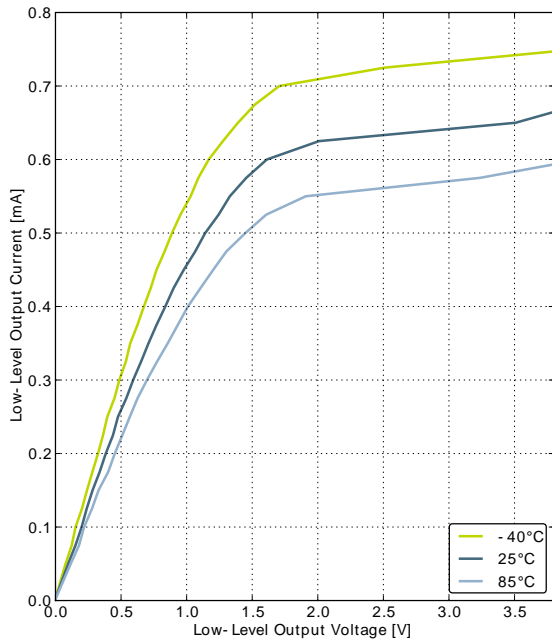


GPIO\_Px\_CTRL DRIVEMODE = STANDARD

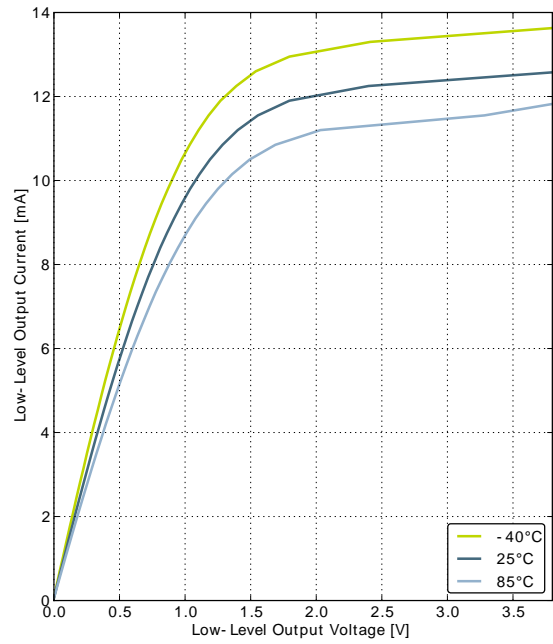


GPIO\_Px\_CTRL DRIVEMODE = HIGH

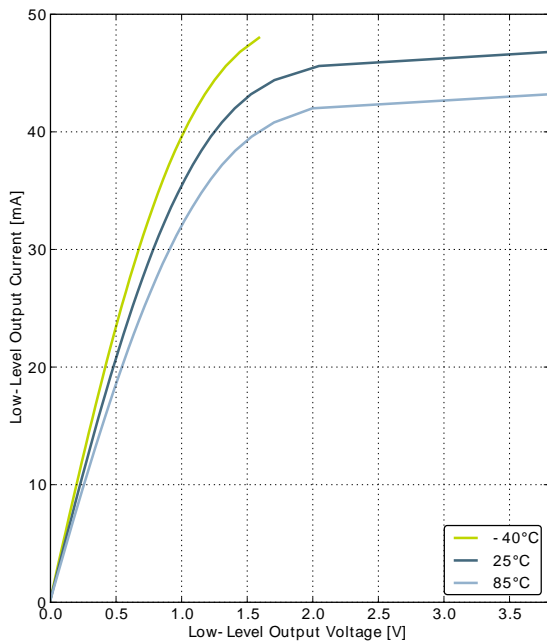
Figure 3.15. Typical Low-Level Output Current, 3.8V Supply Voltage



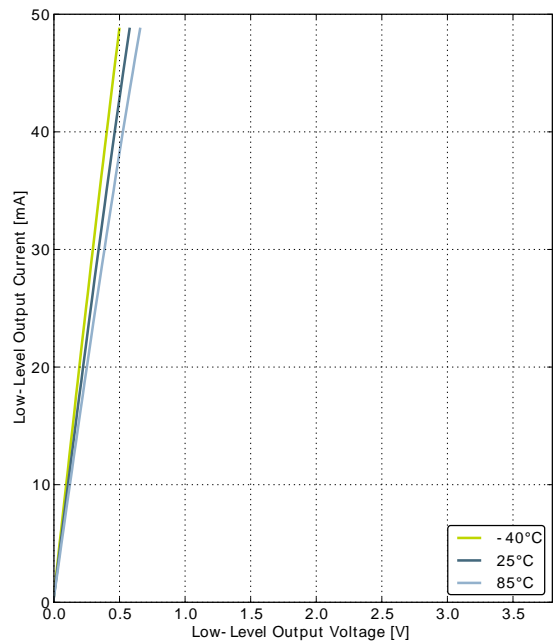
GPIO\_Px\_CTRL DRIVEMODE = LOWEST



GPIO\_Px\_CTRL DRIVEMODE = LOW

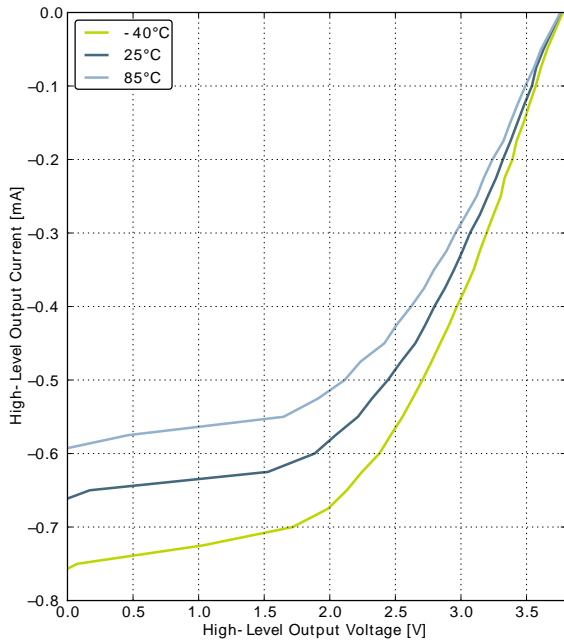


GPIO\_Px\_CTRL DRIVEMODE = STANDARD

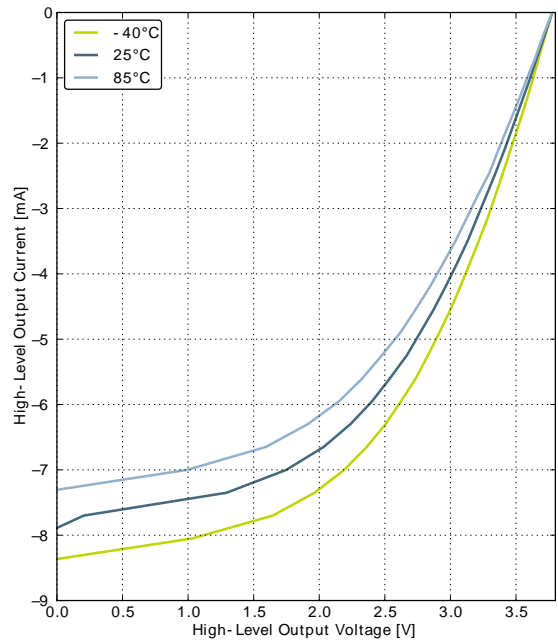


GPIO\_Px\_CTRL DRIVEMODE = HIGH

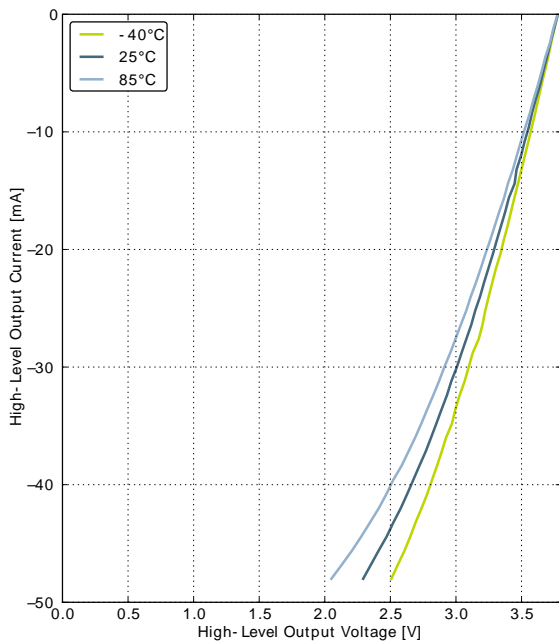
Figure 3.16. Typical High-Level Output Current, 3.8V Supply Voltage



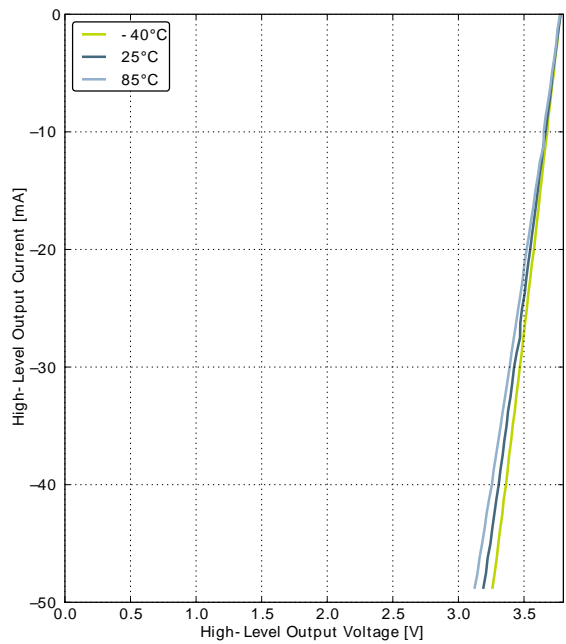
GPIO\_Px\_CTRL DRIVEMODE = LOWEST



GPIO\_Px\_CTRL DRIVEMODE = LOW



GPIO\_Px\_CTRL DRIVEMODE = STANDARD



GPIO\_Px\_CTRL DRIVEMODE = HIGH



## 3.9 Oscillators

### 3.9.1 LFXO

**Table 3.9. LFXO**

| Symbol       | Parameter  | Condition   | Min            | Typ    | Max  | Unit |
|--------------|--|---|----------------|--------|------|------|
| $f_{LFXO}$   | Supported nominal crystal frequency                    |   |                | 32.768 |      | kHz  |
| $ESR_{LFXO}$ | Supported crystal equivalent series resistance (ESR)   |   |                | 30     | 120  | kOhm |
| $C_{LFXOL}$  | Supported crystal external load range                  |   | X <sup>1</sup> |        | 25   | pF   |
| $DC_{LFXO}$  | Duty cycle   |   | 48             | 50     | 53.5 | %    |
| $I_{LFXO}$   | Current consumption for core and buffer after startup. | ESR=30 kOhm, $C_L=10$ pF, LFXOBOOST in CMU_CTRL is 1  |                | 190    |      | nA   |
| $t_{LFXO}$   | Start- up time.  | ESR=30 kOhm, $C_L=10$ pF, 40% - 60% duty cycle has been reached, LFXOBOOST in CMU_CTRL is 1 |                | 400    |      | ms   |

<sup>1</sup>See Minimum Load Capacitance ( $C_{LFXOL}$ ) Requirement For Safe Crystal Startup in energyAware Designer in Simplicity Studio

For safe startup of a given crystal, the energyAware Designer in Simplicity Studio contains a tool to help users configure both load capacitance and software settings for using the LFXO. For details regarding the crystal configuration, the reader is referred to application note "AN0016 EFM32 Oscillator Design Consideration".

### 3.9.2 HFXO

**Table 3.10. HFXO**

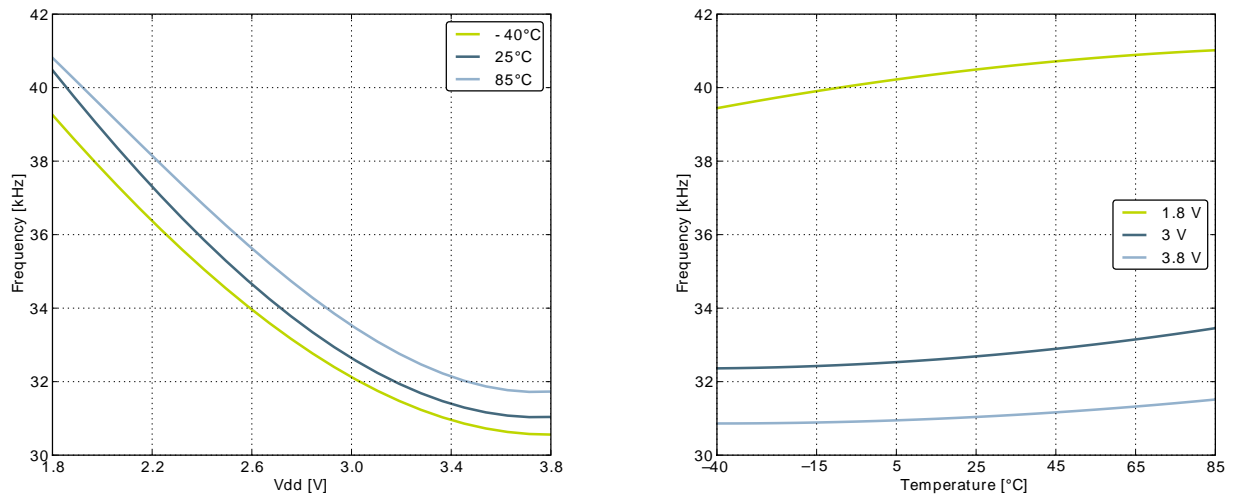
| Symbol                     | Parameter  | Condition  | Min | Typ | Max  | Unit          |
|----------------------------|--|--|-----|-----|------|---------------|
| $f_{\text{HFXO}}$          | Supported nominal crystal Frequency                                  |  | 4   |     | 48   | MHz           |
| $\text{ESR}_{\text{HFXO}}$ | Supported crystal equivalent series resistance (ESR)                 | Crystal frequency 32 MHz   |     | 30  | 60   | Ohm           |
|                            |  | Crystal frequency 4 MHz  |     | 400 | 1500 | Ohm           |
| $g_{\text{mHFXO}}$         | The transconductance of the HFXO input transistor at crystal startup | HFXOBOOST in CMU_CTRL equals 0b11                                  | 20  |     |      | mS            |
| $C_{\text{HFXOL}}$         | Supported crystal external load range                                |  | 5   |     | 25   | pF            |
| $\text{DC}_{\text{HFXO}}$  | Duty cycle   |  | 46  | 50  | 54   | %             |
| $I_{\text{HFXO}}$          | Current consumption for HFXO after startup                           | 4 MHz: ESR=400 Ohm, $C_L=20$ pF, HFXOBOOST in CMU_CTRL equals 0b11 |     | 85  |      | $\mu\text{A}$ |
|                            |  | 32 MHz: ESR=30 Ohm, $C_L=10$ pF, HFXOBOOST in CMU_CTRL equals 0b11 |     | 165 |      | $\mu\text{A}$ |
| $t_{\text{HFXO}}$          | Startup time   | 32 MHz: ESR=30 Ohm, $C_L=10$ pF, HFXOBOOST in CMU_CTRL equals 0b11 |     | 400 |      | $\mu\text{s}$ |

### 3.9.3 LFRCO

**Table 3.11. LFRCO**

| Symbol                           | Parameter   | Condition | Min | Typ    | Max | Unit          |
|----------------------------------|---|-----------|-----|--------|-----|---------------|
| $f_{\text{LFRCO}}$               | Oscillation frequency, $V_{\text{DD}}=3.0$ V, $T_{\text{AMB}}=25^\circ\text{C}$ |           |     | 32.768 |     | kHz           |
| $t_{\text{LFRCO}}$               | Startup time not including software calibration                                 |           |     | 150    |     | $\mu\text{s}$ |
| $I_{\text{LFRCO}}$               | Current consumption   |           |     | 190    |     | nA            |
| $\text{TUNESTEP}_{\text{LFRCO}}$ | Frequency step for LSB change in TUNING value                                   |           |     | 1.5    |     | %             |

Figure 3.17. Calibrated LFRCO Frequency vs Temperature and Supply Voltage

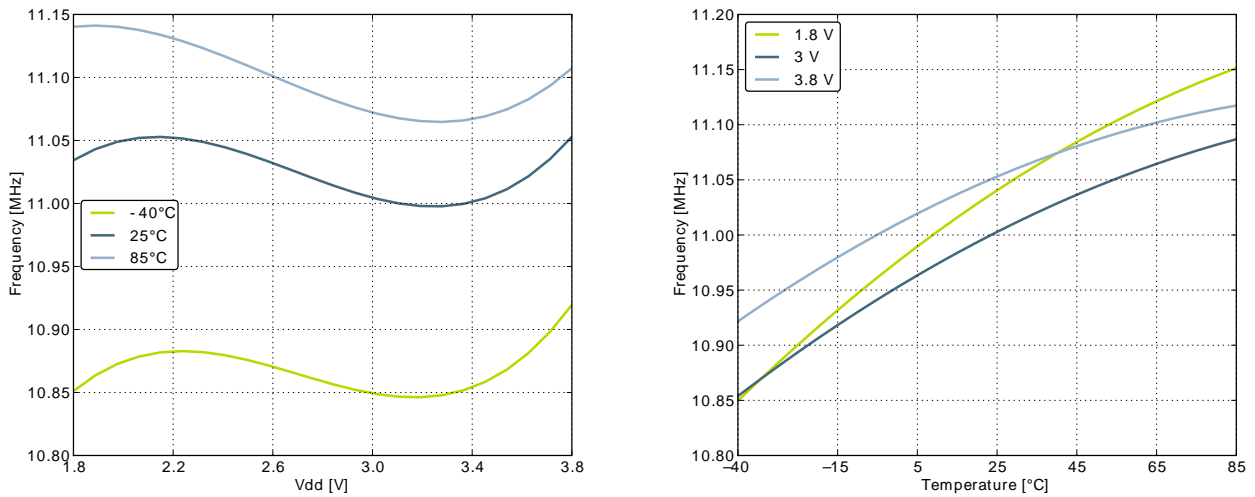


### 3.9.4 HFRCO

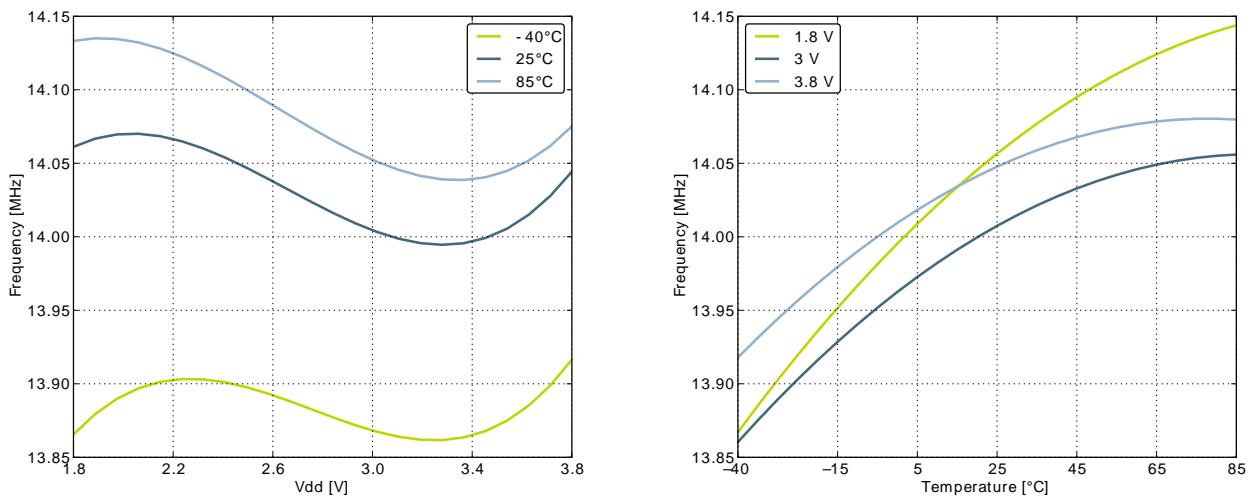
Table 3.12. HFRCO

| Symbol                           | Parameter  | Condition                    | Min  | Typ | Max | Unit   |
|----------------------------------|--|------------------------------|------|-----|-----|--------|
| f <sub>HFRCO</sub>               | Oscillation frequency, V <sub>DD</sub> = 3.0 V, T <sub>AMB</sub> =25°C | 28 MHz frequency band        |      | 28  |     | MHz    |
|                                  |  | 21 MHz frequency band        |      | 21  |     | MHz    |
|                                  |  | 14 MHz frequency band        |      | 14  |     | MHz    |
|                                  |  | 11 MHz frequency band        |      | 11  |     | MHz    |
|                                  |  | 7 MHz frequency band         |      | 6.6 |     | MHz    |
|                                  |  | 1 MHz frequency band         |      | 1.2 |     | MHz    |
| t <sub>HFRCO_settling</sub>      | Settling time after start-up   | f <sub>HFRCO</sub> = 14 MHz  |      | 0.6 |     | Cycles |
| I <sub>HFRCO</sub>               | Current consumption  | f <sub>HFRCO</sub> = 28 MHz  |      | 106 |     | µA     |
|                                  |  | f <sub>HFRCO</sub> = 21 MHz  |      | 93  |     | µA     |
|                                  |  | f <sub>HFRCO</sub> = 14 MHz  |      | 77  |     | µA     |
|                                  |  | f <sub>HFRCO</sub> = 11 MHz  |      | 72  |     | µA     |
|                                  |  | f <sub>HFRCO</sub> = 6.6 MHz |      | 63  |     | µA     |
|                                  |  | f <sub>HFRCO</sub> = 1.2 MHz |      | 22  |     | µA     |
| DC <sub>HFRCO</sub>              | Duty cycle   | f <sub>HFRCO</sub> = 14 MHz  | 48.5 | 50  | 51  | %      |
| TUNESTEP <sub>H-FR</sub><br>FRCO | Frequency step for LSB change in TUNING value                          |                              |      | 0.3 |     | %      |

**Figure 3.18. Calibrated HFRCO 11 MHz Band Frequency vs Supply Voltage and Temperature**



**Figure 3.19. Calibrated HFRCO 14 MHz Band Frequency vs Supply Voltage and Temperature**



**Figure 3.20. Calibrated HFRCO 21 MHz Band Frequency vs Supply Voltage and Temperature**

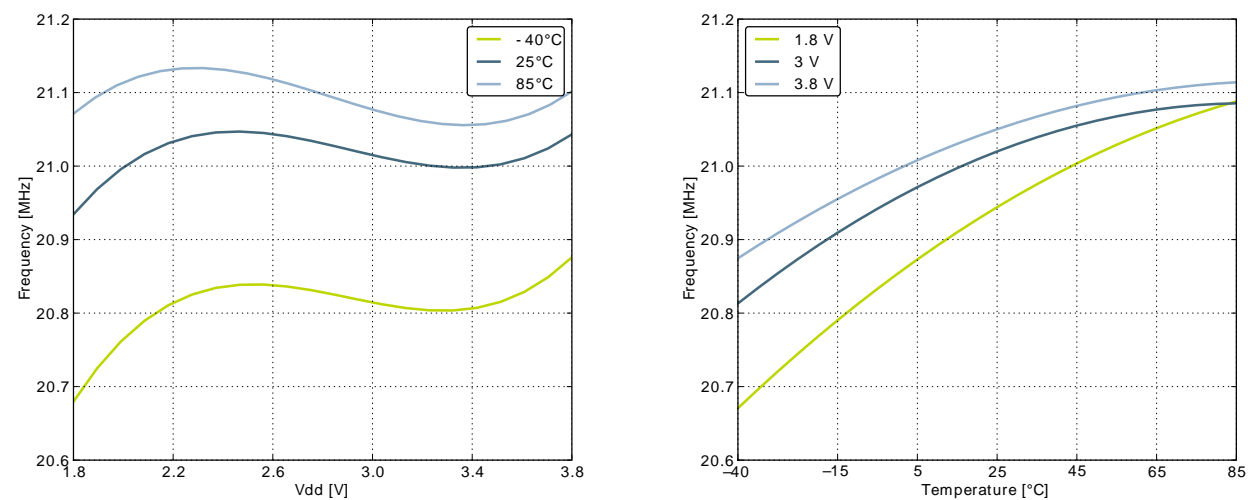
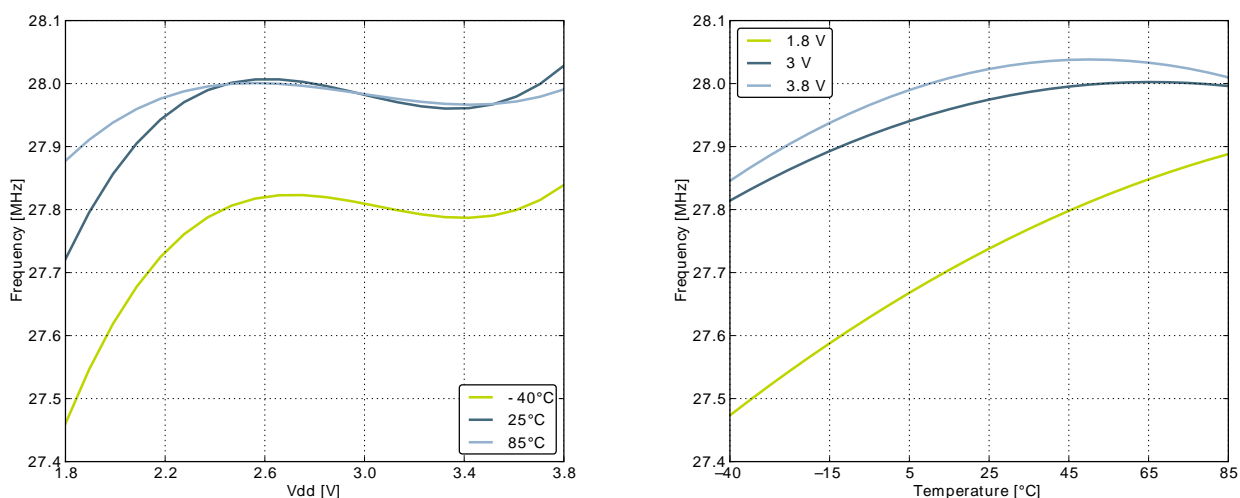


Figure 3.21. Calibrated HFRCO 28 MHz Band Frequency vs Supply Voltage and Temperature



### 3.9.5 ULFRCO

Table 3.13. ULFRCO

| Symbol               | Parameter                  | Condition | Min | Typ   | Max | Unit |
|----------------------|----------------------------|-----------|-----|-------|-----|------|
| f <sub>ULFRCO</sub>  | Oscillation frequency      | 25°C, 3V  | 0.8 |       | 1.5 | kHz  |
| TC <sub>ULFRCO</sub> | Temperature coefficient    |           |     | 0.05  |     | %/°C |
| VC <sub>ULFRCO</sub> | Supply voltage coefficient |           |     | -18.2 |     | %/V  |

### 3.10 Analog Digital Converter (ADC)

Table 3.14. ADC

| Symbol                    | Parameter  | Condition                 | Min                  | Typ  | Max                   | Unit |
|---------------------------|--|---------------------------|----------------------|------|-----------------------|------|
| V <sub>ADCIN</sub>        | Input voltage range  | Single ended              | 0                    |      | V <sub>REF</sub>      | V    |
|                           |  | Differential              | -V <sub>REF</sub> /2 |      | V <sub>REF</sub> /2   | V    |
| V <sub>ADCREFIN</sub>     | Input range of external reference voltage, single ended and differential |                           | 1.25                 |      | V <sub>DD</sub>       | V    |
| V <sub>ADCREFIN_CH7</sub> | Input range of external negative reference voltage on channel 7          | See V <sub>ADCREFIN</sub> | 0                    |      | V <sub>DD</sub> - 1.1 | V    |
| V <sub>ADCREFIN_CH6</sub> | Input range of external positive reference voltage on channel 6          | See V <sub>ADCREFIN</sub> | 0.625                |      | V <sub>DD</sub>       | V    |
| V <sub>ADCCMIN</sub>      | Common mode input range  |                           | 0                    |      | V <sub>DD</sub>       | V    |
| I <sub>ADCIN</sub>        | Input current  | 2pF sampling capacitors   |                      | <100 |                       | nA   |

| Symbol                  | Parameter  | Condition   | Min | Typ | Max | Unit           |
|-------------------------|--|---|-----|-----|-----|----------------|
| CMRR <sub>ADC</sub>     | Analog input common mode rejection ratio                             |   |     | 65  |     | dB             |
| I <sub>ADC</sub>        | Average active current   | 1 MSamples/s, 12 bit, external reference  |     | 351 |     | μA             |
|                         |  | 10 kSamples/s 12 bit, internal 1.25 V reference, WARMUP-MODE in ADCn_CTRL set to 0b00 |     | 67  |     | μA             |
|                         |  | 10 kSamples/s 12 bit, internal 1.25 V reference, WARMUP-MODE in ADCn_CTRL set to 0b01 |     | 63  |     | μA             |
|                         |  | 10 kSamples/s 12 bit, internal 1.25 V reference, WARMUP-MODE in ADCn_CTRL set to 0b10 |     | 64  |     | μA             |
| I <sub>ADCREF</sub>     | Current consumption of internal voltage reference                    | Internal voltage reference  |     | 65  |     | μA             |
| C <sub>ADCIN</sub>      | Input capacitance  |   |     | 2   |     | pF             |
| R <sub>ADCIN</sub>      | Input ON resistance  |   | 1   |     |     | MΩ             |
| R <sub>ADCFLT</sub>     | Input RC filter resistance   |   |     | 10  |     | kΩ             |
| C <sub>ADCFLT</sub>     | Input RC filter/de-coupling capacitance                              |   |     | 250 |     | fF             |
| f <sub>ADCCLK</sub>     | ADC Clock Frequency  |   |     |     | 13  | MHz            |
| t <sub>ADCCONV</sub>    | Conversion time  | 6 bit   |     | 7   |     | ADC-CLK Cycles |
|                         |  | 8 bit   |     | 11  |     | ADC-CLK Cycles |
|                         |  | 12 bit  |     | 13  |     | ADC-CLK Cycles |
| t <sub>ADCACQ</sub>     | Acquisition time   | Programmable  |     | 1   | 256 | ADC-CLK Cycles |
| t <sub>ADCACQVDD3</sub> | Required acquisition time for VDD/3 reference                        |   |     | 2   |     | μs             |
| t <sub>ADCSTART</sub>   | Startup time of reference generator and ADC core in NORMAL mode      |   |     |     | 5   | μs             |
|                         | Startup time of reference generator and ADC core in KEEPADCWARM mode |   |     |     | 1   | μs             |



| Symbol  | Parameter                                    | Condition   | Min | Typ | Max | Unit |
|---|--|---|-----|-----|-----|------|
| SNR <sub>ADC</sub>  | Signal to Noise Ratio (SNR)                  | 1 MSamples/s, 12 bit, single ended, internal 1.25V reference    |     | 59  |     | dB   |
|   |  | 1 MSamples/s, 12 bit, single ended, internal 2.5V reference     |     | 63  |     | dB   |
|   |  | 1 MSamples/s, 12 bit, single ended, V <sub>DD</sub> reference   |     | 65  |     | dB   |
|   |  | 1 MSamples/s, 12 bit, differential, internal 1.25V reference    |     | 60  |     | dB   |
|   |  | 1 MSamples/s, 12 bit, differential, internal 2.5V reference     |     | 65  |     | dB   |
|   |  | 1 MSamples/s, 12 bit, differential, 5V reference                |     | 54  |     | dB   |
|   |  | 1 MSamples/s, 12 bit, differential, V <sub>DD</sub> reference   |     | 67  |     | dB   |
|   |  | 1 MSamples/s, 12 bit, differential, 2xV <sub>DD</sub> reference |     | 69  |     | dB   |
|   |  | 200 kSamples/s, 12 bit, single ended, internal 1.25V reference  |     | 62  |     | dB   |
|   |  | 200 kSamples/s, 12 bit, single ended, internal 2.5V reference   |     | 63  |     | dB   |
|   |  | 200 kSamples/s, 12 bit, single ended, V <sub>DD</sub> reference |     | 67  |     | dB   |
|   |  | 200 kSamples/s, 12 bit, differential, internal 1.25V reference  |     | 63  |     | dB   |
|   |  | 200 kSamples/s, 12 bit, differential, internal 2.5V reference   |     | 66  |     | dB   |
|   |  | 200 kSamples/s, 12 bit, differential, 5V reference              |     | 66  |     | dB   |
|   |  | 200 kSamples/s, 12 bit, differential, V <sub>DD</sub> reference |     | 69  |     | dB   |
| 200 kSamples/s, 12 bit, differential, 2xV <sub>DD</sub> reference |  | 70  |     | dB  |     |      |
| SINAD <sub>ADC</sub>  | Signal-to-Noise And Distortion-ratio (SINAD) | 1 MSamples/s, 12 bit, single ended, internal 1.25V reference    |     | 58  |     | dB   |
|   |  | 1 MSamples/s, 12 bit, single ended, internal 2.5V reference     |     | 62  |     | dB   |
|   |  | 1 MSamples/s, 12 bit, single ended, V <sub>DD</sub> reference   |     | 64  |     | dB   |
|   |  | 1 MSamples/s, 12 bit, differential, internal 1.25V reference    |     | 60  |     | dB   |
|   |  | 1 MSamples/s, 12 bit, differential, internal 2.5V reference     |     | 64  |     | dB   |
|   |  | 1 MSamples/s, 12 bit, differential, 5V reference                |     | 54  |     | dB   |
|   |  | 1 MSamples/s, 12 bit, differential, V <sub>DD</sub> reference   |     | 66  |     | dB   |

| Symbol              | Parameter                           | Condition   | Min | Typ | Max | Unit |
|---------------------|-------------------------------------|---|-----|-----|-----|------|
|                     |                                     | 1 MSamples/s, 12 bit, differential, 2xV <sub>DD</sub> reference   |     | 68  |     | dB   |
|                     |                                     | 200 kSamples/s, 12 bit, single ended, internal 1.25V reference    |     | 61  |     | dB   |
|                     |                                     | 200 kSamples/s, 12 bit, single ended, internal 2.5V reference     |     | 65  |     | dB   |
|                     |                                     | 200 kSamples/s, 12 bit, single ended, V <sub>DD</sub> reference   |     | 66  |     | dB   |
|                     |                                     | 200 kSamples/s, 12 bit, differential, internal 1.25V reference    |     | 63  |     | dB   |
|                     |                                     | 200 kSamples/s, 12 bit, differential, internal 2.5V reference     |     | 66  |     | dB   |
|                     |                                     | 200 kSamples/s, 12 bit, differential, 5V reference                |     | 66  |     | dB   |
|                     |                                     | 200 kSamples/s, 12 bit, differential, V <sub>DD</sub> reference   |     | 68  |     | dB   |
|                     |                                     | 200 kSamples/s, 12 bit, differential, 2xV <sub>DD</sub> reference |     | 69  |     | dB   |
| SFDR <sub>ADC</sub> | Spurious-Free Dynamic Range (SF-DR) | 1 MSamples/s, 12 bit, single ended, internal 1.25V reference      |     | 64  |     | dBc  |
|                     |                                     | 1 MSamples/s, 12 bit, single ended, internal 2.5V reference       |     | 76  |     | dBc  |
|                     |                                     | 1 MSamples/s, 12 bit, single ended, V <sub>DD</sub> reference     |     | 73  |     | dBc  |
|                     |                                     | 1 MSamples/s, 12 bit, differential, internal 1.25V reference      |     | 66  |     | dBc  |
|                     |                                     | 1 MSamples/s, 12 bit, differential, internal 2.5V reference       |     | 77  |     | dBc  |
|                     |                                     | 1 MSamples/s, 12 bit, differential, V <sub>DD</sub> reference     |     | 76  |     | dBc  |
|                     |                                     | 1 MSamples/s, 12 bit, differential, 2xV <sub>DD</sub> reference   |     | 75  |     | dBc  |
|                     |                                     | 1 MSamples/s, 12 bit, differential, 5V reference                  |     | 69  |     | dBc  |
|                     |                                     | 200 kSamples/s, 12 bit, single ended, internal 1.25V reference    |     | 75  |     | dBc  |
|                     |                                     | 200 kSamples/s, 12 bit, single ended, internal 2.5V reference     |     | 75  |     | dBc  |
|                     |                                     | 200 kSamples/s, 12 bit, single ended, V <sub>DD</sub> reference   |     | 76  |     | dBc  |
|                     |                                     | 200 kSamples/s, 12 bit, differential, internal 1.25V reference    |     | 79  |     | dBc  |
|                     |                                     | 200 kSamples/s, 12 bit, differential, internal 2.5V reference     |     | 79  |     | dBc  |
|                     |                                     | 200 kSamples/s, 12 bit, differential, 5V reference                |     | 78  |     | dBc  |

| Symbol                 | Parameter                                      | Condition   | Min                 | Typ               | Max                | Unit         |
|------------------------|--|---|---------------------|-------------------|--------------------|--------------|
|                        |  | 200 kSamples/s, 12 bit, differential, V <sub>DD</sub> reference   |                     | 79                |                    | dBc          |
|                        |  | 200 kSamples/s, 12 bit, differential, 2xV <sub>DD</sub> reference |                     | 79                |                    | dBc          |
| V <sub>ADCOFFSET</sub> | Offset voltage                                 | After calibration, single ended                                   |                     | 0.3               |                    | mV           |
|                        |  | After calibration, differential                                   |                     | 0.3               |                    | mV           |
| TGRAD <sub>ADCTH</sub> | Thermometer output gradient                    |   |                     | -1.92             |                    | mV/°C        |
|                        |  |   |                     | -6.3              |                    | ADC Codes/°C |
| DNL <sub>ADC</sub>     | Differential non-linearity (DNL)               |   |                     | ±0.7              |                    | LSB          |
| INL <sub>ADC</sub>     | Integral non-linearity (INL), End point method |   |                     | ±1.2              |                    | LSB          |
| MC <sub>ADC</sub>      | No missing codes                               |   | 11.999 <sup>1</sup> | 12                |                    | bits         |
| GAIN <sub>ED</sub>     | Gain error drift                               | 1.25V reference   |                     | 0.01 <sup>2</sup> | 0.033 <sup>3</sup> | %/°C         |
|                        |  | 2.5V reference  |                     | 0.01 <sup>2</sup> | 0.03 <sup>3</sup>  | %/°C         |
| OFFSET <sub>ED</sub>   | Offset error drift                             | 1.25V reference   |                     | 0.2 <sup>2</sup>  | 0.7 <sup>3</sup>   | LSB/°C       |
|                        |  | 2.5V reference  |                     | 0.2 <sup>2</sup>  | 0.62 <sup>3</sup>  | LSB/°C       |

<sup>1</sup>On the average every ADC will have one missing code, most likely to appear around 2048 +/- n\*512 where n can be a value in the set {-3, -2, -1, 1, 2, 3}. There will be no missing code around 2048, and in spite of the missing code the ADC will be monotonic at all times so that a response to a slowly increasing input will always be a slowly increasing output. Around the one code that is missing, the neighbour codes will look wider in the DNL plot. The spectra will show spurs on the level of -78dBc for a full scale input for chips that have the missing code issue.

<sup>2</sup>Typical numbers given by abs(Mean) / (85 - 25).

<sup>3</sup>Max number given by (abs(Mean) + 3x stdev) / (85 - 25).

The integral non-linearity (INL) and differential non-linearity parameters are explained in Figure 3.22 (p. 36) and Figure 3.23 (p. 36) , respectively.

Figure 3.22. Integral Non-Linearity (INL)

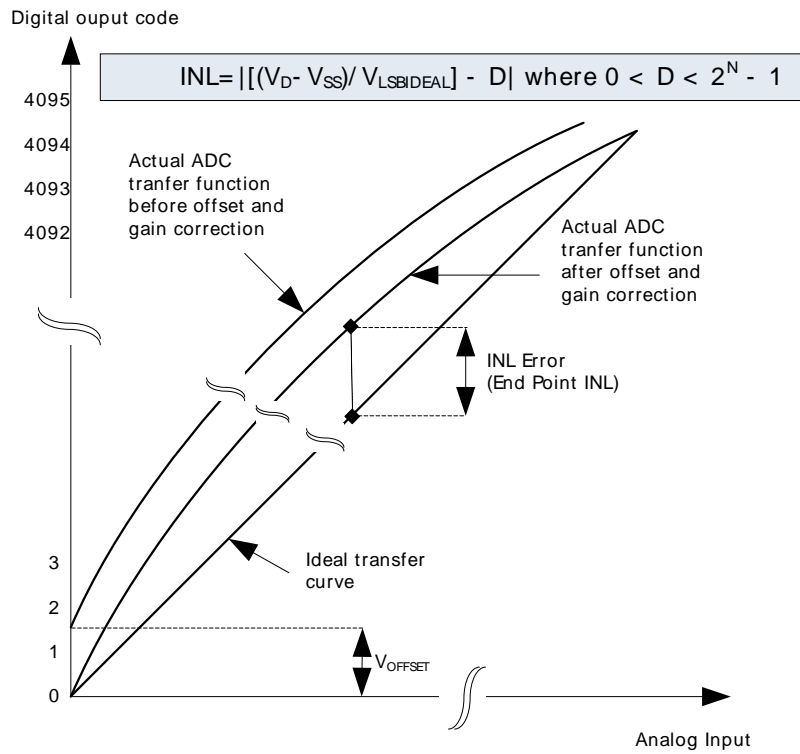
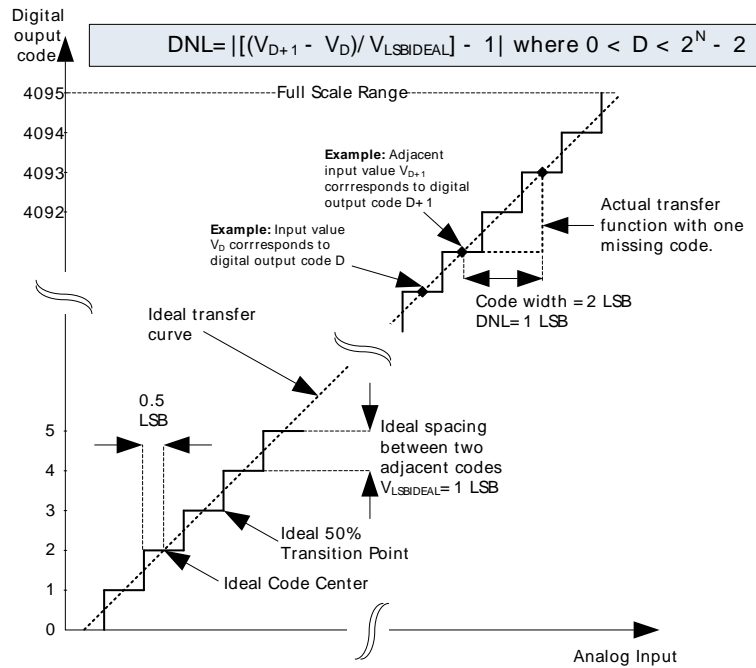
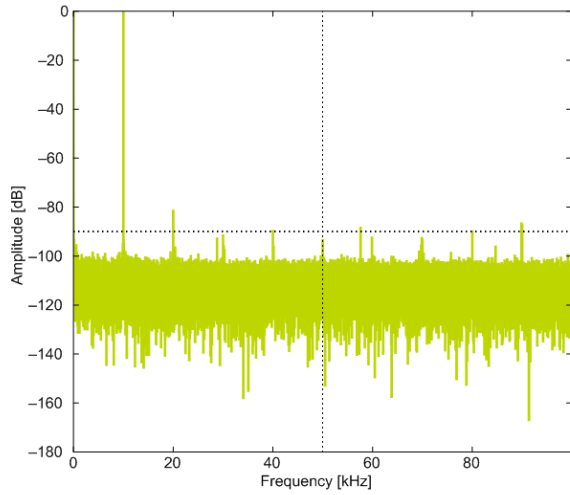


Figure 3.23. Differential Non-Linearity (DNL)

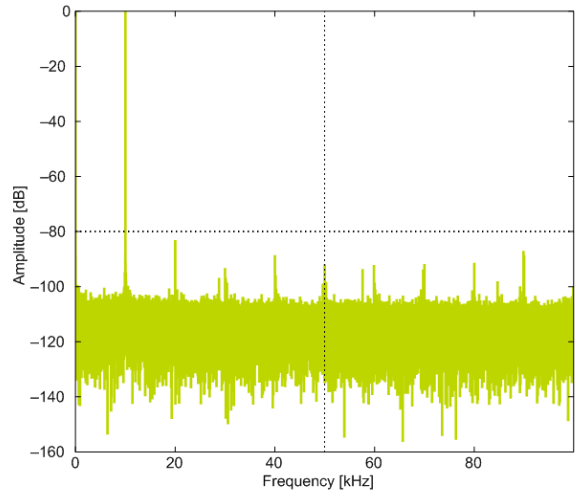


### 3.10.1 Typical performance

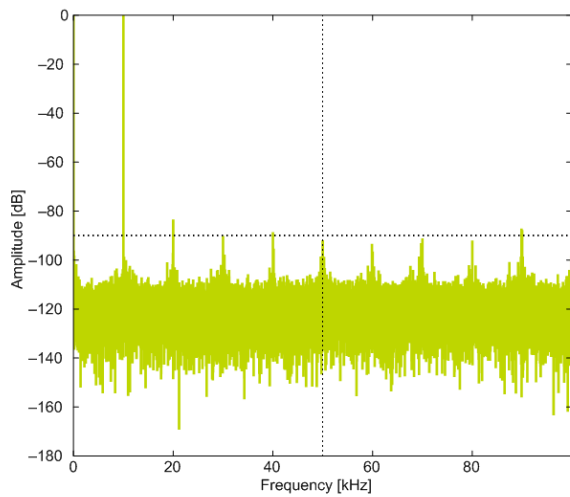
Figure 3.24. ADC Frequency Spectrum, Vdd = 3V, Temp = 25°C



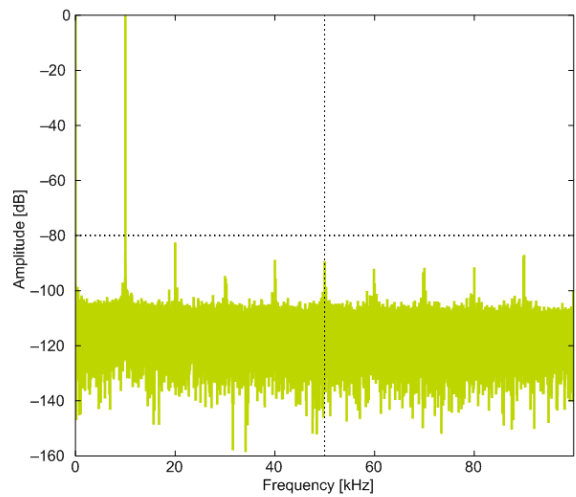
1.25V Reference



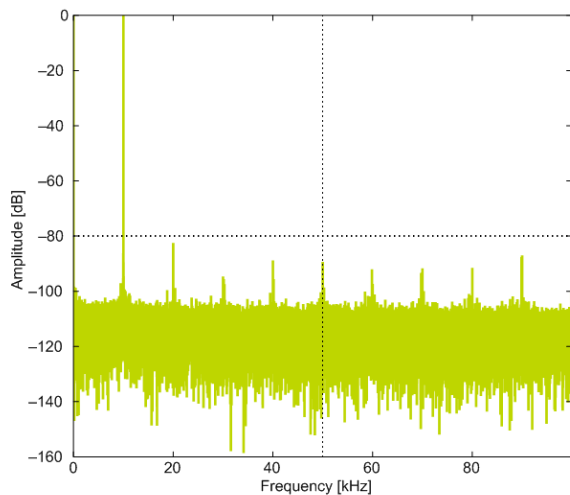
2.5V Reference



2XVDDVSS Reference

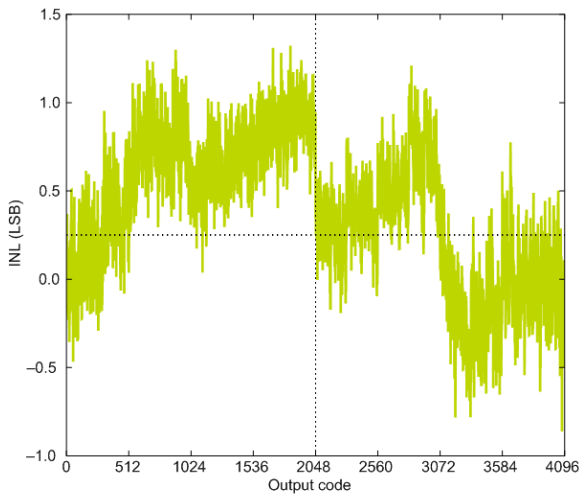


5VDIFF Reference

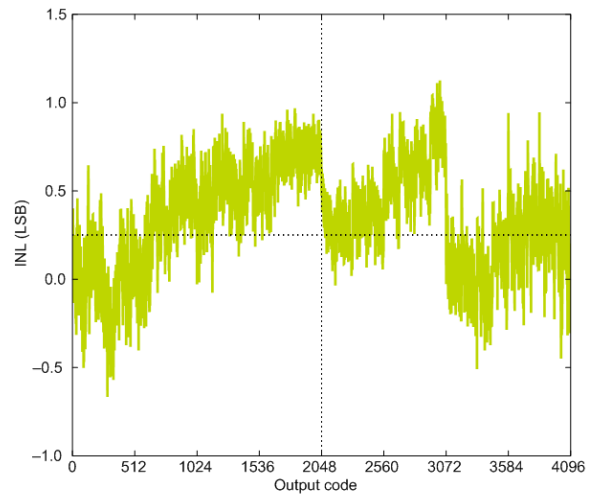


VDD Reference

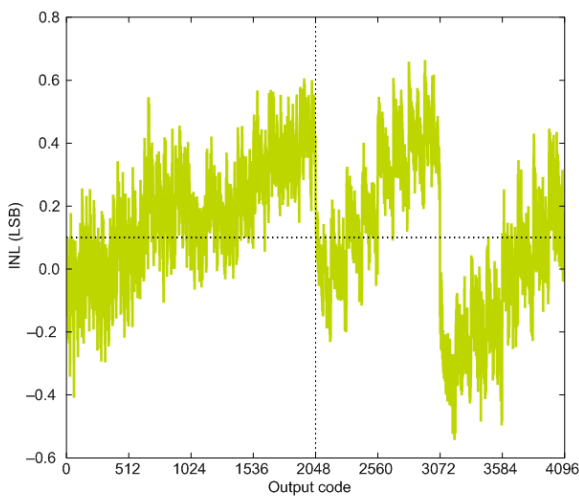
Figure 3.25. ADC Integral Linearity Error vs Code, Vdd = 3V, Temp = 25°C



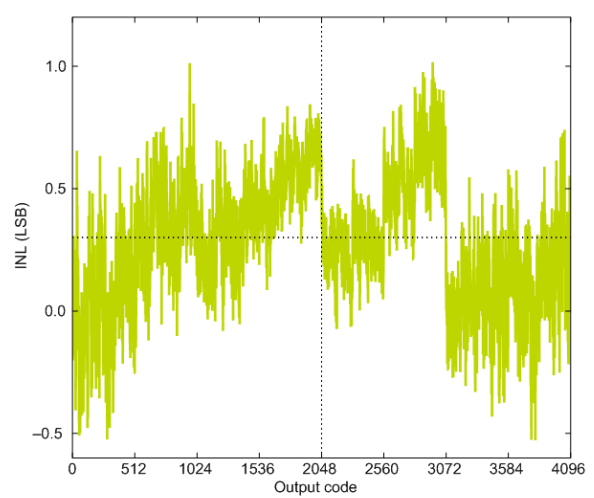
1.25V Reference



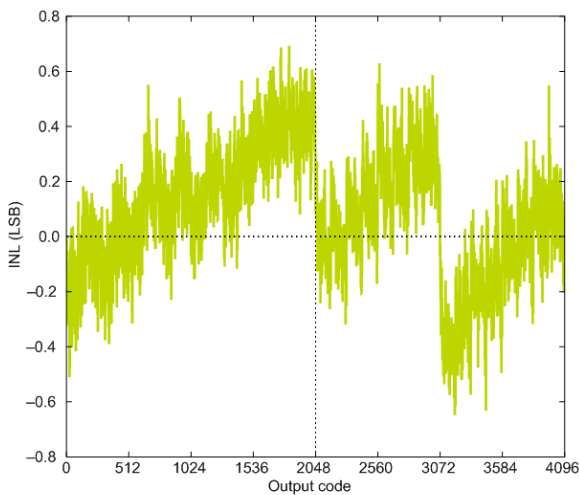
2.5V Reference



2XVDDVSS Reference

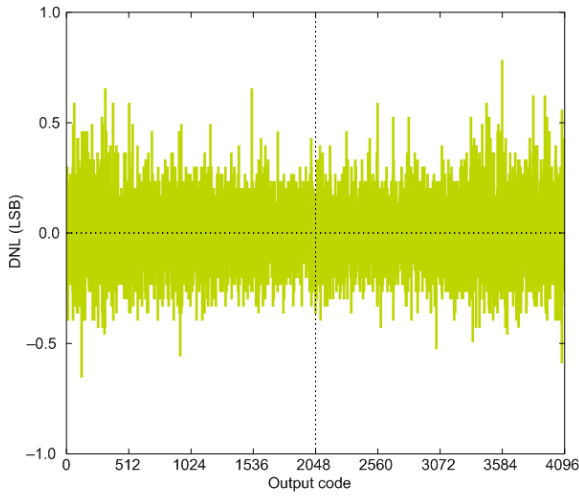


5VDIFF Reference

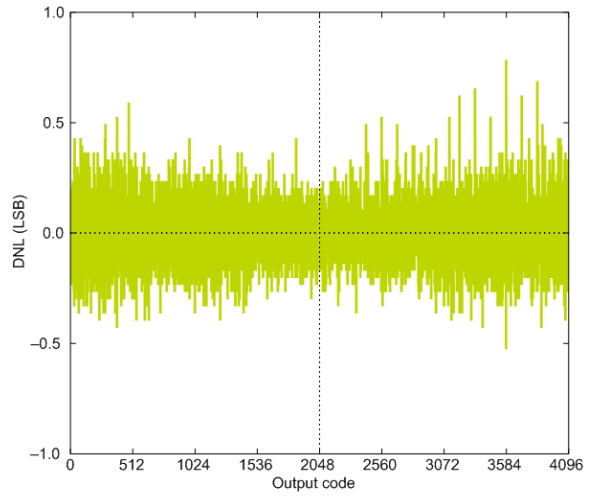


VDD Reference

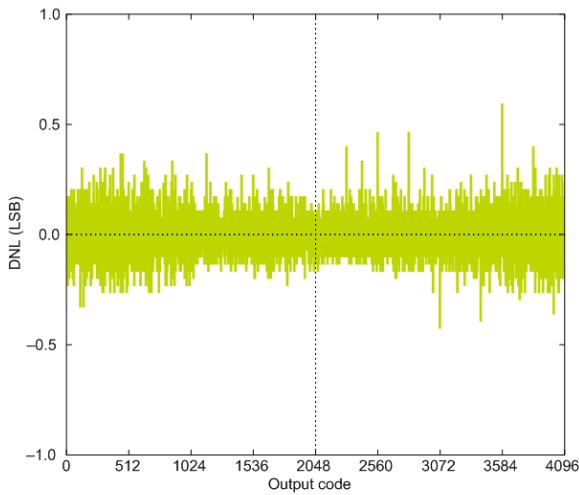
Figure 3.26. ADC Differential Linearity Error vs Code, Vdd = 3V, Temp = 25°C



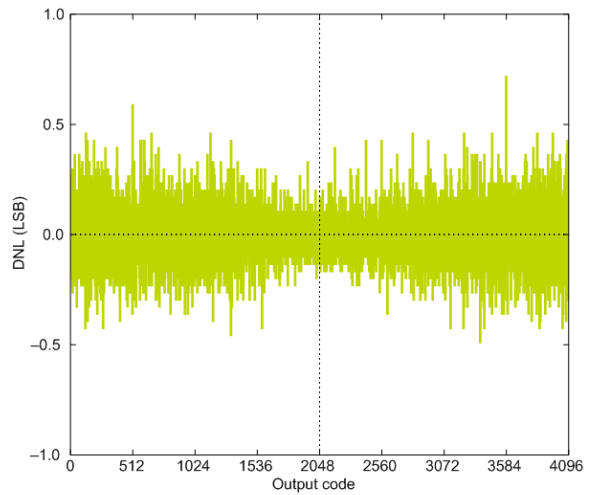
1.25V Reference



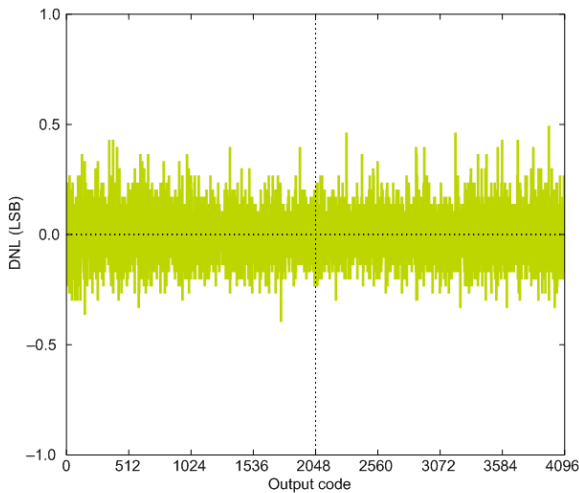
2.5V Reference



2XVDDVSS Reference

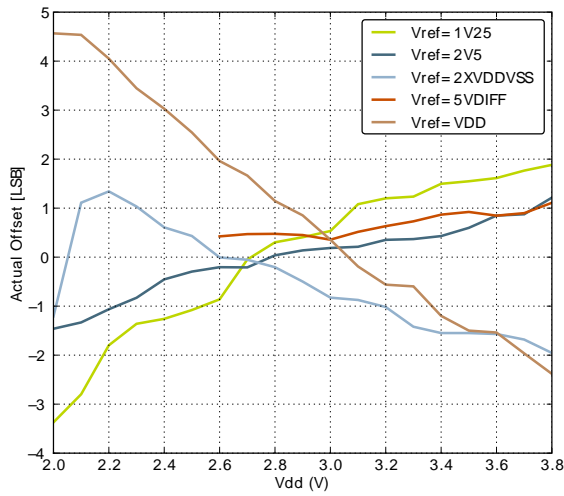


5VDIFF Reference

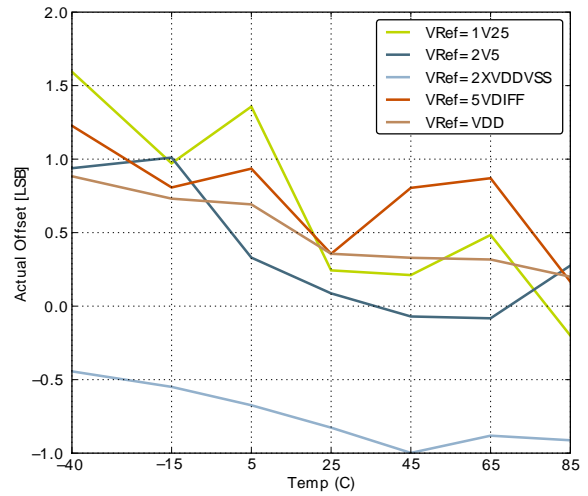


VDD Reference

Figure 3.27. ADC Absolute Offset, Common Mode = Vdd / 2

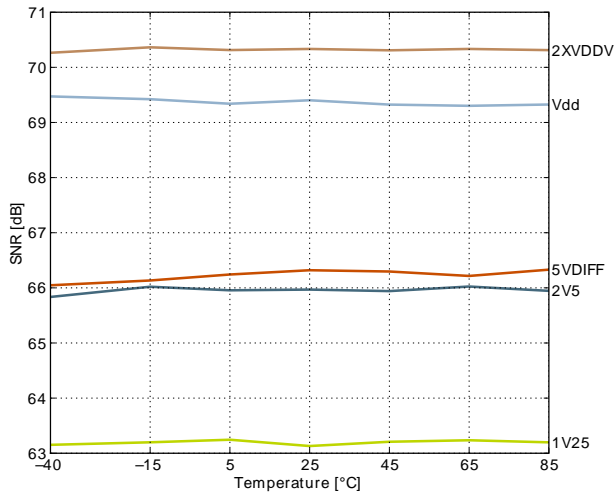


Offset vs Supply Voltage, Temp = 25°C

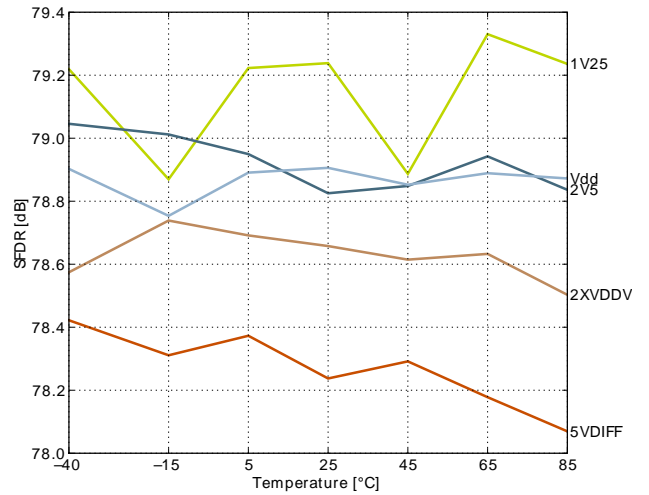


Offset vs Temperature, Vdd = 3V

Figure 3.28. ADC Dynamic Performance vs Temperature for all ADC References, Vdd = 3V



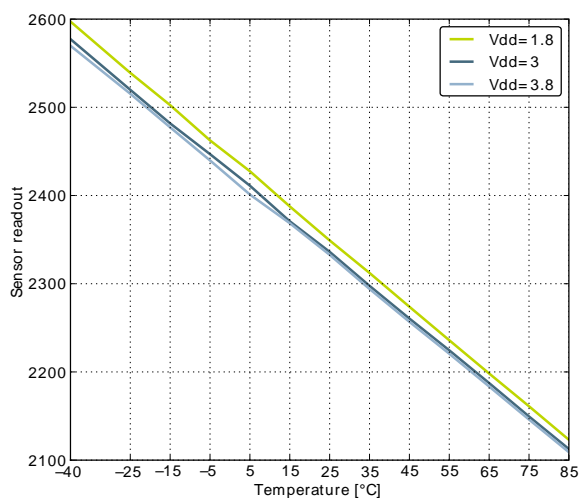
Signal to Noise Ratio (SNR)



Spurious-Free Dynamic Range (SFDR)



Figure 3.29. ADC Temperature sensor readout



### 3.11 Digital Analog Converter (DAC)

Table 3.15. DAC

| Symbol                 | Parameter  | Condition  | Min              | Typ | Max             | Unit       |
|------------------------|--|--|------------------|-----|-----------------|------------|
| V <sub>DACOUT</sub>    | Output voltage range                               | VDD voltage reference, single ended                            | 0                |     | V <sub>DD</sub> | V          |
|                        |  | VDD voltage reference, differential                            | -V <sub>DD</sub> |     | V <sub>DD</sub> | V          |
| V <sub>DACCM</sub>     | Output common mode voltage range                   |  | 0                |     | V <sub>DD</sub> | V          |
| I <sub>DAC</sub>       | Active current including references for 2 channels | 500 kSamples/s, 12bit  |                  | 400 |                 | μA         |
|                        |  | 100 kSamples/s, 12 bit   |                  | 200 |                 | μA         |
|                        |  | 1 kSamples/s 12 bit NORMAL                                     |                  | 38  |                 | μA         |
| SR <sub>DAC</sub>      | Sample rate  |  |                  |     | 500             | ksamples/s |
| f <sub>DAC</sub>       | DAC clock frequency                                | Continuous Mode  |                  |     | 1000            | kHz        |
|                        |  | Sample/Hold Mode   |                  |     | 250             | kHz        |
|                        |  | Sample/Off Mode  |                  |     | 250             | kHz        |
| CYC <sub>DACCONV</sub> | Clock cycles per conversion                        |  |                  | 2   |                 |            |
| t <sub>DACCONV</sub>   | Conversion time                                    |  | 2                |     |                 | μs         |
| t <sub>DACSETTLE</sub> | Settling time                                      |  |                  | 5   |                 | μs         |
| SNR <sub>DAC</sub>     | Signal to Noise Ratio (SNR)                        | 500 kSamples/s, 12 bit, single ended, internal 1.25V reference |                  | 58  |                 | dB         |
|                        |  | 500 kSamples/s, 12 bit, single ended, internal 2.5V reference  |                  | 59  |                 | dB         |
|                        |  | 500 kSamples/s, 12 bit, differential, internal 1.25V reference |                  | 58  |                 | dB         |

| Symbol                 | Parameter                                     | Condition   | Min | Typ | Max | Unit |
|------------------------|---|---|-----|-----|-----|------|
|                        |   | 500 kSamples/s, 12 bit, differential, internal 2.5V reference   |     | 58  |     | dB   |
|                        |   | 500 kSamples/s, 12 bit, differential, V <sub>DD</sub> reference |     | 59  |     | dB   |
| SNDR <sub>DAC</sub>    | Signal to Noise-pulse Distortion Ratio (SNDR) | 500 kSamples/s, 12 bit, single ended, internal 1.25V reference  |     | 57  |     | dB   |
|                        |   | 500 kSamples/s, 12 bit, single ended, internal 2.5V reference   |     | 54  |     | dB   |
|                        |   | 500 kSamples/s, 12 bit, differential, internal 1.25V reference  |     | 56  |     | dB   |
|                        |   | 500 kSamples/s, 12 bit, differential, internal 2.5V reference   |     | 53  |     | dB   |
|                        |   | 500 kSamples/s, 12 bit, differential, V <sub>DD</sub> reference |     | 55  |     | dB   |
| SFDR <sub>DAC</sub>    | Spurious-Free Dynamic Range(SFDR)             | 500 kSamples/s, 12 bit, single ended, internal 1.25V reference  |     | 62  |     | dBc  |
|                        |   | 500 kSamples/s, 12 bit, single ended, internal 2.5V reference   |     | 56  |     | dBc  |
|                        |   | 500 kSamples/s, 12 bit, differential, internal 1.25V reference  |     | 61  |     | dBc  |
|                        |   | 500 kSamples/s, 12 bit, differential, internal 2.5V reference   |     | 55  |     | dBc  |
|                        |   | 500 kSamples/s, 12 bit, differential, V <sub>DD</sub> reference |     | 60  |     | dBc  |
| V <sub>DACOFFSET</sub> | Offset voltage                                | After calibration, single ended                                 |     | 2   |     | mV   |
|                        |   | After calibration, differential                                 |     | 2   |     | mV   |
| DNL <sub>DAC</sub>     | Differential non-linearity                    |   |     | ±1  |     | LSB  |
| INL <sub>DAC</sub>     | Integral non-linearity                        |   |     | ±5  |     | LSB  |
| MC <sub>DAC</sub>      | No missing codes                              |   |     | 12  |     | bits |

### 3.12 Operational Amplifier (OPAMP)

The electrical characteristics for the Operational Amplifiers are based on simulations.

**Table 3.16. OPAMP**

| Symbol             | Parameter      | Condition  | Min | Typ | Max | Unit |
|--------------------|----------------|--|-----|-----|-----|------|
| I <sub>OPAMP</sub> | Active Current | (OPA2)BIASPROG=0xF, (OPA2)HALFBIAS=0x0, Unity Gain |     | 400 |     | µA   |
|                    |                | (OPA2)BIASPROG=0x7, (OPA2)HALFBIAS=0x1, Unity Gain |     | 100 |     | µA   |
|                    |                | (OPA2)BIASPROG=0x0, (OPA2)HALFBIAS=0x1, Unity Gain |     | 13  |     | µA   |

| Symbol                    | Parameter                  | Condition   | Min             | Typ  | Max                  | Unit              |
|---------------------------|----------------------------|---|-----------------|------|----------------------|-------------------|
| G <sub>OL</sub>           | Open Loop Gain             | (OPA2)BIASPROG=0xF,<br>(OPA2)HALFBIAS=0x0   |                 | 101  |                      | dB                |
|                           |                            | (OPA2)BIASPROG=0x7,<br>(OPA2)HALFBIAS=0x1   |                 | 98   |                      | dB                |
|                           |                            | (OPA2)BIASPROG=0x0,<br>(OPA2)HALFBIAS=0x1   |                 | 91   |                      | dB                |
| GBW <sub>OPAMP</sub>      | Gain Bandwidth Product     | (OPA2)BIASPROG=0xF,<br>(OPA2)HALFBIAS=0x0   |                 | 6.1  |                      | MHz               |
|                           |                            | (OPA2)BIASPROG=0x7,<br>(OPA2)HALFBIAS=0x1   |                 | 1.8  |                      | MHz               |
|                           |                            | (OPA2)BIASPROG=0x0,<br>(OPA2)HALFBIAS=0x1   |                 | 0.25 |                      | MHz               |
| PM <sub>OPAMP</sub>       | Phase Margin               | (OPA2)BIASPROG=0xF,<br>(OPA2)HALFBIAS=0x0, C <sub>L</sub> =75 pF                  |                 | 64   |                      | °                 |
|                           |                            | (OPA2)BIASPROG=0x7,<br>(OPA2)HALFBIAS=0x1, C <sub>L</sub> =75 pF                  |                 | 58   |                      | °                 |
|                           |                            | (OPA2)BIASPROG=0x0,<br>(OPA2)HALFBIAS=0x1, C <sub>L</sub> =75 pF                  |                 | 58   |                      | °                 |
| R <sub>INPUT</sub>        | Input Resistance           |   |                 | 100  |                      | Mohm              |
| R <sub>LOAD</sub>         | Load Resistance            |   | 200             |      |                      | Ohm               |
| I <sub>LOAD_DC</sub>      | DC Load Current            |   |                 |      | 11                   | mA                |
| V <sub>INPUT</sub>        | Input Voltage              | OPAxHCMDIS=0  | V <sub>SS</sub> |      | V <sub>DD</sub>      | V                 |
|                           |                            | OPAxHCMDIS=1  | V <sub>SS</sub> |      | V <sub>DD</sub> -1.2 | V                 |
| V <sub>OUTPUT</sub>       | Output Voltage             |   | V <sub>SS</sub> |      | V <sub>DD</sub>      | V                 |
| V <sub>OFFSET</sub>       | Input Offset Voltage       | Unity Gain, V <sub>SS</sub> <V <sub>in</sub> <V <sub>DD</sub> , OPAX-HCMDIS=0     |                 | 6    |                      | mV                |
|                           |                            | Unity Gain, V <sub>SS</sub> <V <sub>in</sub> <V <sub>DD</sub> -1.2, OPAX-HCMDIS=1 |                 | 1    |                      | mV                |
| V <sub>OFFSET_DRIFT</sub> | Input Offset Voltage Drift |   |                 |      | 0.02                 | mV/°C             |
| SR <sub>OPAMP</sub>       | Slew Rate                  | (OPA2)BIASPROG=0xF,<br>(OPA2)HALFBIAS=0x0   |                 | 3.2  |                      | V/μs              |
|                           |                            | (OPA2)BIASPROG=0x7,<br>(OPA2)HALFBIAS=0x1   |                 | 0.8  |                      | V/μs              |
|                           |                            | (OPA2)BIASPROG=0x0,<br>(OPA2)HALFBIAS=0x1   |                 | 0.1  |                      | V/μs              |
| N <sub>OPAMP</sub>        | Voltage Noise              | V <sub>out</sub> =1V, RESSEL=0,<br>0.1 Hz<f<10 kHz, OPAX-HCMDIS=0                 |                 | 101  |                      | μV <sub>RMS</sub> |
|                           |                            | V <sub>out</sub> =1V, RESSEL=0,<br>0.1 Hz<f<10 kHz, OPAX-HCMDIS=1                 |                 | 141  |                      | μV <sub>RMS</sub> |
|                           |                            | V <sub>out</sub> =1V, RESSEL=0, 0.1 Hz<f<1 MHz, OPAX-HCMDIS=0                     |                 | 196  |                      | μV <sub>RMS</sub> |

| Symbol | Parameter | Condition   | Min | Typ  | Max | Unit          |
|--------|-----------|---|-----|------|-----|---------------|
|        |           | $V_{out}=1V$ , RESSEL=0, 0.1 Hz<f<1 MHz, OPAXHCMDIS=1 |     | 229  |     | $\mu V_{RMS}$ |
|        |           | RESSEL=7, 0.1 Hz<f<10 kHz, OPAXHCMDIS=0               |     | 1230 |     | $\mu V_{RMS}$ |
|        |           | RESSEL=7, 0.1 Hz<f<10 kHz, OPAXHCMDIS=1               |     | 2130 |     | $\mu V_{RMS}$ |
|        |           | RESSEL=7, 0.1 Hz<f<1 MHz, OPAXHCMDIS=0                |     | 1630 |     | $\mu V_{RMS}$ |
|        |           | RESSEL=7, 0.1 Hz<f<1 MHz, OPAXHCMDIS=1                |     | 2590 |     | $\mu V_{RMS}$ |

Figure 3.30. OPAMP Common Mode Rejection Ratio

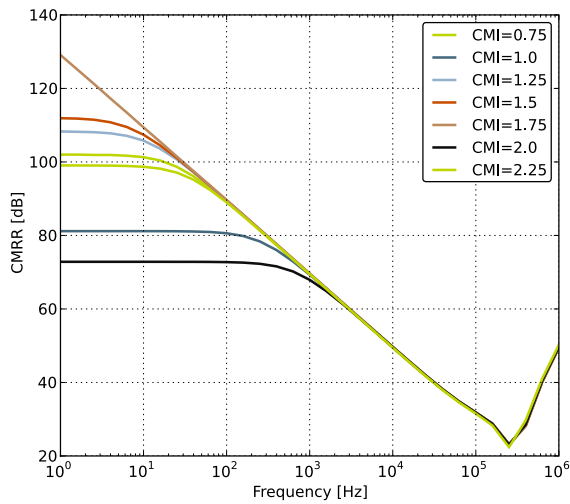
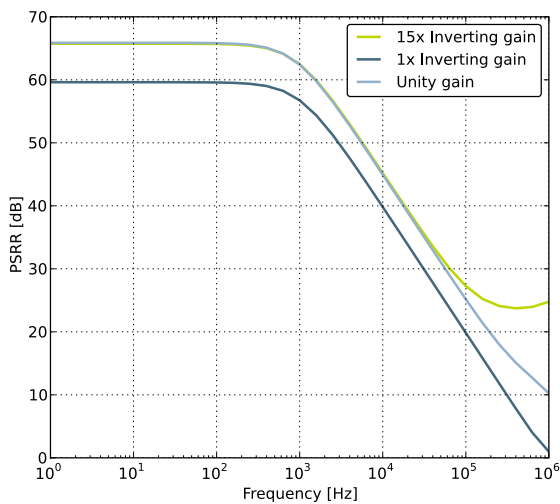
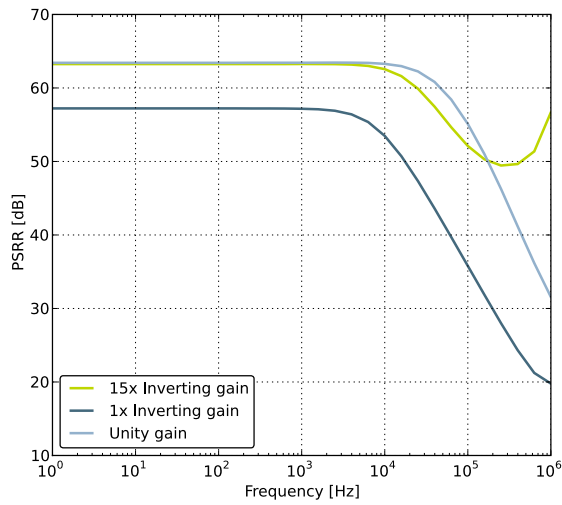


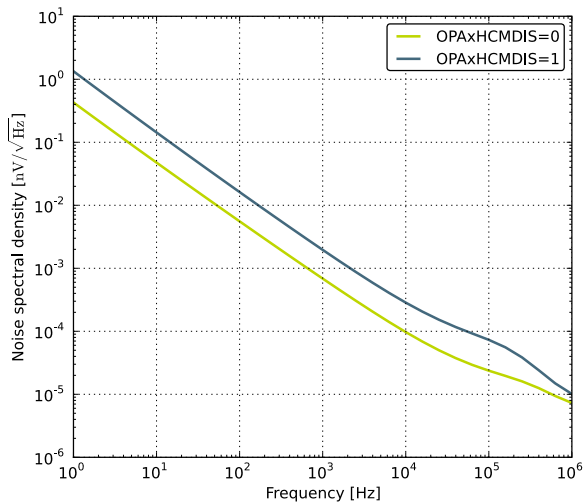
Figure 3.31. OPAMP Positive Power Supply Rejection Ratio



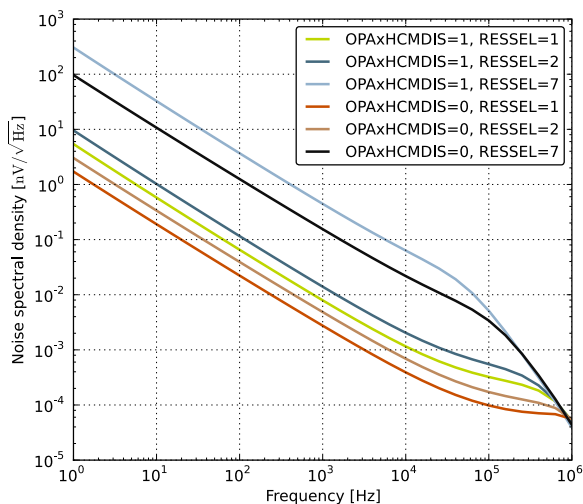
**Figure 3.32. OPAMP Negative Power Supply Rejection Ratio**



**Figure 3.33. OPAMP Voltage Noise Spectral Density (Unity Gain)  $V_{out}=1V$**



**Figure 3.34. OPAMP Voltage Noise Spectral Density (Non-Unity Gain)**



## 3.13 Analog Comparator (ACMP)

**Table 3.17. ACMP**

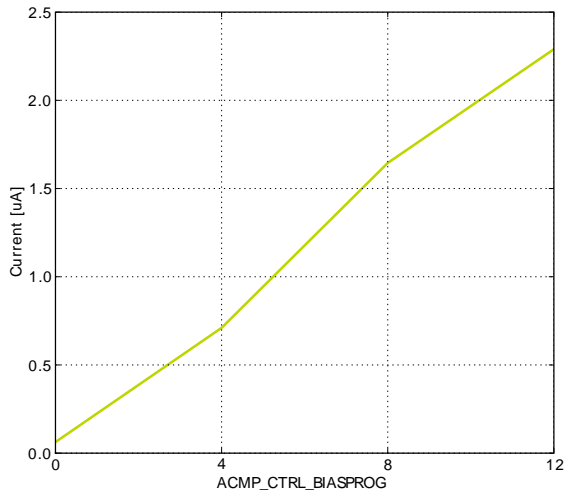
| Symbol                  | Parameter   | Condition  | Min | Typ  | Max             | Unit |
|-------------------------|---|--|-----|------|-----------------|------|
| V <sub>ACMPIN</sub>     | Input voltage range                               |  | 0   |      | V <sub>DD</sub> | V    |
| V <sub>ACMPCM</sub>     | ACMP Common Mode voltage range                    |  | 0   |      | V <sub>DD</sub> | V    |
| I <sub>ACMP</sub>       | Active current                                    | BIASPROG=0b0000, FULL-BIAS=0 and HALFBIAS=1 in ACMPn_CTRL register |     | 0.1  |                 | μA   |
|                         |   | BIASPROG=0b1111, FULL-BIAS=0 and HALFBIAS=0 in ACMPn_CTRL register |     | 2.87 |                 | μA   |
|                         |   | BIASPROG=0b1111, FULL-BIAS=1 and HALFBIAS=0 in ACMPn_CTRL register |     | 195  |                 | μA   |
| I <sub>ACMPREF</sub>    | Current consumption of internal voltage reference | Internal voltage reference off. Using external voltage reference   |     | 0    |                 | μA   |
|                         |   | Internal voltage reference   |     | 5    |                 | μA   |
| V <sub>ACMPOFFSET</sub> | Offset voltage                                    | Single ended   |     | 10   |                 | mV   |
|                         |   | Differential   |     | 10   |                 | mV   |
| V <sub>ACMPHYST</sub>   | ACMP hysteresis                                   | Programmable   |     | 17   |                 | mV   |
| R <sub>CSRES</sub>      | Capacitive Sense Internal Resistance              | CSRESSEL=0b00 in ACMPn_INPUTSEL                                    |     | 39   |                 | kOhm |
|                         |   | CSRESSEL=0b01 in ACMPn_INPUTSEL                                    |     | 71   |                 | kOhm |
|                         |   | CSRESSEL=0b10 in ACMPn_INPUTSEL                                    |     | 104  |                 | kOhm |
|                         |   | CSRESSEL=0b11 in ACMPn_INPUTSEL                                    |     | 136  |                 | kOhm |
| t <sub>ACMPSTART</sub>  | Startup time                                      |  |     |      | 10              | μs   |

The total ACMP current is the sum of the contributions from the ACMP and its internal voltage reference as given in Equation 3.1 (p. 46) . I<sub>ACMPREF</sub> is zero if an external voltage reference is used.

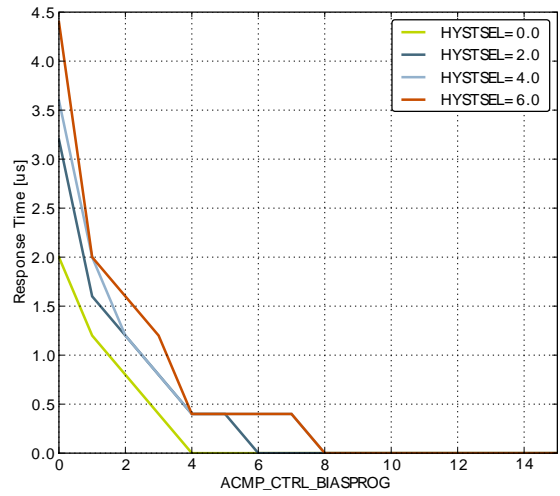
### Total ACMP Active Current

$$I_{ACMPTOTAL} = I_{ACMP} + I_{ACMPREF} \quad (3.1)$$

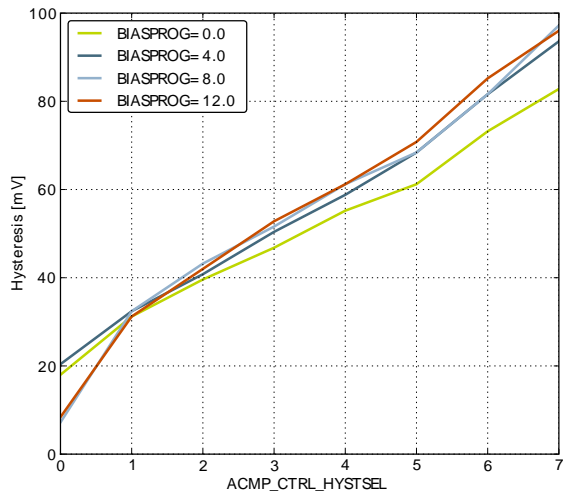
Figure 3.35. ACMP Characteristics, Vdd = 3V, Temp = 25°C, FULLBIAS = 0, HALFBIAS = 1



Current consumption, HYSTSEL = 4



Response time



Hysteresis

## 3.14 Voltage Comparator (VCMP)

**Table 3.18. VCMP**

| Symbol                             | Parameter                        | Condition   | Min | Typ             | Max | Unit |
|------------------------------------|----------------------------------|---|-----|-----------------|-----|------|
| V <sub>VCMPIN</sub>                | Input voltage range              |   |     | V <sub>DD</sub> |     | V    |
| V <sub>VCMP<sub>CM</sub></sub>     | VCMP Common Mode voltage range   |   |     | V <sub>DD</sub> |     | V    |
| I <sub>VCMP</sub>                  | Active current                   | BIASPROG=0b0000 and HALFBIAS=1 in VCMPn_CTRL register           |     | 0.1             |     | μA   |
|                                    |                                  | BIASPROG=0b1111 and HALFBIAS=0 in VCMPn_CTRL register. LPREF=0. |     | 14.7            |     | μA   |
| t <sub>VCMPREF</sub>               | Startup time reference generator | NORMAL  |     | 10              |     | μs   |
| V <sub>VCMP<sub>OFFSET</sub></sub> | Offset voltage                   | Single ended  |     | 10              |     | mV   |
|                                    |                                  | Differential  |     | 10              |     | mV   |
| V <sub>VCMP<sub>HYST</sub></sub>   | VCMP hysteresis                  |   |     | 17              |     | mV   |
| t <sub>VCMP<sub>START</sub></sub>  | Startup time                     |   |     |                 | 10  | μs   |

The V<sub>DD</sub> trigger level can be configured by setting the TRIGLEVEL field of the VCMP\_CTRL register in accordance with the following equation:

### **VCMP Trigger Level as a Function of Level Setting**

$$V_{DD \text{ Trigger Level}} = 1.667V + 0.034 \times \text{TRIGLEVEL} \quad (3.2)$$



### 3.15 LCD

**Table 3.19. LCD**

| Symbol                | Parameter  | Condition  | Min | Typ  | Max | Unit |
|-----------------------|--|--|-----|------|-----|------|
| f <sub>LCDFR</sub>    | Frame rate   |  | 30  |      | 200 | Hz   |
| NUM <sub>SEG</sub>    | Number of segments supported                         |  |     | 36x8 |     | seg  |
| V <sub>LCD</sub>      | LCD supply voltage range                             | Internal boost circuit enabled   | 2.0 |      | 3.8 | V    |
| I <sub>LCD</sub>      | Steady state current consumption.                    | Display disconnected, static mode, framerate 32 Hz, all segments on.   |     | 250  |     | nA   |
|                       |  | Display disconnected, quadruplex mode, framerate 32 Hz, all segments on, bias mode to ONETHIRD in LCD_DISPCTRL register. |     | 550  |     | nA   |
| I <sub>LCDBOOST</sub> | Steady state Current contribution of internal boost. | Internal voltage boost off   |     | 0    |     | μA   |
|                       |  | Internal voltage boost on, boosting from 2.2 V to 3.0 V.   |     | 8.4  |     | μA   |
| V <sub>BOOST</sub>    | Boost Voltage  | VBLEV of LCD_DISPCTRL register to LEVEL0   |     | 3.0  |     | V    |
|                       |  | VBLEV of LCD_DISPCTRL register to LEVEL1   |     | 3.08 |     | V    |
|                       |  | VBLEV of LCD_DISPCTRL register to LEVEL2   |     | 3.17 |     | V    |
|                       |  | VBLEV of LCD_DISPCTRL register to LEVEL3   |     | 3.26 |     | V    |
|                       |  | VBLEV of LCD_DISPCTRL register to LEVEL4   |     | 3.34 |     | V    |
|                       |  | VBLEV of LCD_DISPCTRL register to LEVEL5   |     | 3.43 |     | V    |
|                       |  | VBLEV of LCD_DISPCTRL register to LEVEL6   |     | 3.52 |     | V    |
|                       |  | VBLEV of LCD_DISPCTRL register to LEVEL7   |     | 3.6  |     | V    |

The total LCD current is given by Equation 3.3 (p. 49) . I<sub>LCDBOOST</sub> is zero if internal boost is off.

**Total LCD Current Based on Operational Mode and Internal Boost**

$$I_{LCDTOTAL} = I_{LCD} + I_{LCDBOOST} \tag{3.3}$$

## 3.16 I2C

**Table 3.20. I2C Standard-mode (Sm)**

| Symbol              | Parameter  | Min | Typ | Max                 | Unit |
|---------------------|--|-----|-----|---------------------|------|
| f <sub>SCL</sub>    | SCL clock frequency                                | 0   |     | 100 <sup>1</sup>    | kHz  |
| t <sub>LOW</sub>    | SCL clock low time                                 | 4.7 |     |                     | μs   |
| t <sub>HIGH</sub>   | SCL clock high time                                | 4.0 |     |                     | μs   |
| t <sub>SU,DAT</sub> | SDA set-up time                                    | 250 |     |                     | ns   |
| t <sub>HD,DAT</sub> | SDA hold time                                      | 8   |     | 3450 <sup>2,3</sup> | ns   |
| t <sub>SU,STA</sub> | Repeated START condition set-up time               | 4.7 |     |                     | μs   |
| t <sub>HD,STA</sub> | (Repeated) START condition hold time               | 4.0 |     |                     | μs   |
| t <sub>SU,STO</sub> | STOP condition set-up time                         | 4.0 |     |                     | μs   |
| t <sub>BUF</sub>    | Bus free time between a STOP and a START condition | 4.7 |     |                     | μs   |

<sup>1</sup>For the minimum HPPERCLK frequency required in Standard-mode, see the I2C chapter in the EFM32WG Reference Manual.

<sup>2</sup>The maximum SDA hold time (t<sub>HD,DAT</sub>) needs to be met only when the device does not stretch the low time of SCL (t<sub>LOW</sub>).

<sup>3</sup>When transmitting data, this number is guaranteed only when  $I2Cn\_CLKDIV < ((3450 \cdot 10^{-9} [s] \cdot f_{HPPERCLK} [Hz]) - 4)$ .

**Table 3.21. I2C Fast-mode (Fm)**

| Symbol              | Parameter  | Min | Typ | Max                | Unit |
|---------------------|--|-----|-----|--------------------|------|
| f <sub>SCL</sub>    | SCL clock frequency                                | 0   |     | 400 <sup>1</sup>   | kHz  |
| t <sub>LOW</sub>    | SCL clock low time                                 | 1.3 |     |                    | μs   |
| t <sub>HIGH</sub>   | SCL clock high time                                | 0.6 |     |                    | μs   |
| t <sub>SU,DAT</sub> | SDA set-up time                                    | 100 |     |                    | ns   |
| t <sub>HD,DAT</sub> | SDA hold time                                      | 8   |     | 900 <sup>2,3</sup> | ns   |
| t <sub>SU,STA</sub> | Repeated START condition set-up time               | 0.6 |     |                    | μs   |
| t <sub>HD,STA</sub> | (Repeated) START condition hold time               | 0.6 |     |                    | μs   |
| t <sub>SU,STO</sub> | STOP condition set-up time                         | 0.6 |     |                    | μs   |
| t <sub>BUF</sub>    | Bus free time between a STOP and a START condition | 1.3 |     |                    | μs   |

<sup>1</sup>For the minimum HPPERCLK frequency required in Fast-mode, see the I2C chapter in the EFM32WG Reference Manual.

<sup>2</sup>The maximum SDA hold time (t<sub>HD,DAT</sub>) needs to be met only when the device does not stretch the low time of SCL (t<sub>LOW</sub>).

<sup>3</sup>When transmitting data, this number is guaranteed only when  $I2Cn\_CLKDIV < ((900 \cdot 10^{-9} [s] \cdot f_{HPPERCLK} [Hz]) - 4)$ .

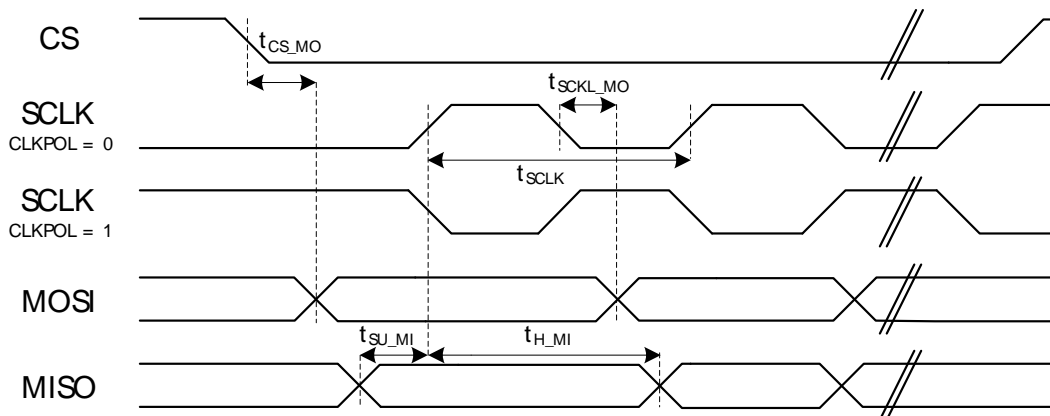
**Table 3.22. I2C Fast-mode Plus (Fm+)**

| Symbol              | Parameter  | Min  | Typ | Max               | Unit |
|---------------------|--|------|-----|-------------------|------|
| f <sub>SCL</sub>    | SCL clock frequency                                | 0    |     | 1000 <sup>1</sup> | kHz  |
| t <sub>LOW</sub>    | SCL clock low time                                 | 0.5  |     |                   | μs   |
| t <sub>HIGH</sub>   | SCL clock high time                                | 0.26 |     |                   | μs   |
| t <sub>SU,DAT</sub> | SDA set-up time                                    | 50   |     |                   | ns   |
| t <sub>HD,DAT</sub> | SDA hold time                                      | 8    |     |                   | ns   |
| t <sub>SU,STA</sub> | Repeated START condition set-up time               | 0.26 |     |                   | μs   |
| t <sub>HD,STA</sub> | (Repeated) START condition hold time               | 0.26 |     |                   | μs   |
| t <sub>SU,STO</sub> | STOP condition set-up time                         | 0.26 |     |                   | μs   |
| t <sub>BUF</sub>    | Bus free time between a STOP and a START condition | 0.5  |     |                   | μs   |

<sup>1</sup>For the minimum HFPERCLK frequency required in Fast-mode Plus, see the I2C chapter in the EFM32WG Reference Manual.

### 3.17 USART SPI

**Figure 3.36. SPI Master Timing**



**Table 3.23. SPI Master Timing**

| Symbol                              | Parameter       | Condition     | Min                        | Typ | Max  | Unit |
|-------------------------------------|-----------------|---------------|----------------------------|-----|------|------|
| t <sub>SCLK</sub> <sup>1,2</sup>    | SCLK period     |               | 2 * t <sub>HFPER-CLK</sub> |     |      | ns   |
| t <sub>CS_MO</sub> <sup>1,2</sup>   | CS to MOSI      |               | -2.00                      |     | 2.00 | ns   |
| t <sub>SCLK_MO</sub> <sup>1,2</sup> | SCLK to MOSI    |               | -1.00                      |     | 3.00 | ns   |
| t <sub>SU_MI</sub> <sup>1,2</sup>   | MISO setup time | IOVDD = 3.0 V | 36.00                      |     |      | ns   |
| t <sub>H_MI</sub> <sup>1,2</sup>    | MISO hold time  |               | -6.00                      |     |      | ns   |

<sup>1</sup>Applies for both CLKPHA = 0 and CLKPHA = 1 (figure only shows CLKPHA = 0)

<sup>2</sup>Measurement done at 10% and 90% of V<sub>DD</sub> (figure shows 50% of V<sub>DD</sub>)

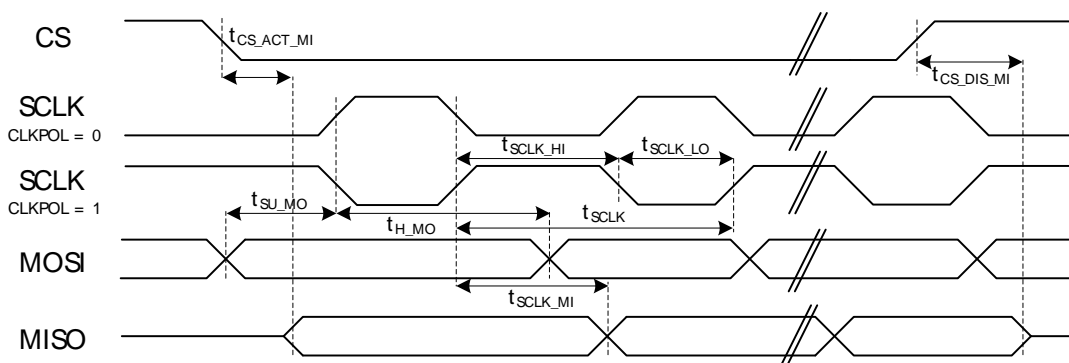
**Table 3.24. SPI Master Timing with SSSEARLY and SMSDELAY**

| Symbol               | Parameter       | Condition     | Min                 | Typ | Max  | Unit |
|----------------------|-----------------|---------------|---------------------|-----|------|------|
| $t_{SCLK}^{1,2}$     | SCLK period     |               | $2 * t_{HFPER-CLK}$ |     |      | ns   |
| $t_{CS\_MO}^{1,2}$   | CS to MOSI      |               | -2.00               |     | 2.00 | ns   |
| $t_{SCLK\_MO}^{1,2}$ | SCLK to MOSI    |               | -1.00               |     | 3.00 | ns   |
| $t_{SU\_MI}^{1,2}$   | MISO setup time | IOVDD = 3.0 V | -32.00              |     |      | ns   |
| $t_{H\_MI}^{1,2}$    | MISO hold time  |               | 63.00               |     |      | ns   |

<sup>1</sup>Applies for both CLKPHA = 0 and CLKPHA = 1 (figure only shows CLKPHA = 0)

<sup>2</sup>Measurement done at 10% and 90% of  $V_{DD}$  (figure shows 50% of  $V_{DD}$ )

**Figure 3.37. SPI Slave Timing**



**Table 3.25. SPI Slave Timing**

| Symbol                  | Parameter          | Min                    | Typ | Max                     | Unit |
|-------------------------|--------------------|------------------------|-----|-------------------------|------|
| $t_{SCLK\_sl}^{1,2}$    | SCKL period        | $6 * t_{HFPER-CLK}$    |     |                         | ns   |
| $t_{SCLK\_hi}^{1,2}$    | SCLK high period   | $3 * t_{HFPER-CLK}$    |     |                         | ns   |
| $t_{SCLK\_lo}^{1,2}$    | SCLK low period    | $3 * t_{HFPER-CLK}$    |     |                         | ns   |
| $t_{CS\_ACT\_MI}^{1,2}$ | CS active to MISO  | 5.00                   |     | 35.00                   | ns   |
| $t_{CS\_DIS\_MI}^{1,2}$ | CS disable to MISO | 5.00                   |     | 35.00                   | ns   |
| $t_{SU\_MO}^{1,2}$      | MOSI setup time    | 5.00                   |     |                         | ns   |
| $t_{H\_MO}^{1,2}$       | MOSI hold time     | $2 + 2 * t_{HFPERCLK}$ |     |                         | ns   |
| $t_{SCLK\_MI}^{1,2}$    | SCLK to MISO       | $7 + t_{HFPER-CLK}$    |     | $42 + 2 * t_{HFPERCLK}$ | ns   |

<sup>1</sup>Applies for both CLKPHA = 0 and CLKPHA = 1 (figure only shows CLKPHA = 0)

<sup>2</sup>Measurement done at 10% and 90% of  $V_{DD}$  (figure shows 50% of  $V_{DD}$ )

**Table 3.26. SPI Slave Timing with SSSEARLY and SMSDELAY**

| Symbol               | Parameter   | Min                 | Typ | Max | Unit |
|----------------------|-------------|---------------------|-----|-----|------|
| $t_{SCLK\_sl}^{1,2}$ | SCKL period | $6 * t_{HFPER-CLK}$ |     |     | ns   |

| Symbol                        | Parameter          | Min                            | Typ | Max                              | Unit |
|-------------------------------|--------------------|--------------------------------|-----|----------------------------------|------|
| $t_{\text{SCLK\_hi}}^{12}$    | SCLK high period   | $3 * t_{\text{HFPER-CLK}}$     |     |                                  | ns   |
| $t_{\text{SCLK\_lo}}^{12}$    | SCLK low period    | $3 * t_{\text{HFPER-CLK}}$     |     |                                  | ns   |
| $t_{\text{CS\_ACT\_MI}}^{12}$ | CS active to MISO  | 5.00                           |     | 35.00                            | ns   |
| $t_{\text{CS\_DIS\_MI}}^{12}$ | CS disable to MISO | 5.00                           |     | 35.00                            | ns   |
| $t_{\text{SU\_MO}}^{12}$      | MOSI setup time    | 5.00                           |     |                                  | ns   |
| $t_{\text{H\_MO}}^{12}$       | MOSI hold time     | $2 + 2 * t_{\text{HF-PERCLK}}$ |     |                                  | ns   |
| $t_{\text{SCLK\_MI}}^{12}$    | SCLK to MISO       | $-264 + t_{\text{HF-PERCLK}}$  |     | $-234 + 2 * t_{\text{HFPERCLK}}$ | ns   |

<sup>1</sup>Applies for both CLKPHA = 0 and CLKPHA = 1 (figure only shows CLKPHA = 0)

<sup>2</sup>Measurement done at 10% and 90% of  $V_{\text{DD}}$  (figure shows 50% of  $V_{\text{DD}}$ )

## 3.18 Digital Peripherals

**Table 3.27. Digital Peripherals**

| Symbol               | Parameter       | Condition                           | Min | Typ  | Max | Unit                     |
|----------------------|-----------------|-------------------------------------|-----|------|-----|--------------------------|
| $I_{\text{USART}}$   | USART current   | USART idle current, clock enabled   |     | 7.5  |     | $\mu\text{A}/\text{MHz}$ |
| $I_{\text{UART}}$    | UART current    | UART idle current, clock enabled    |     | 5.63 |     | $\mu\text{A}/\text{MHz}$ |
| $I_{\text{LEUART}}$  | LEUART current  | LEUART idle current, clock enabled  |     | 150  |     | nA                       |
| $I_{\text{I2C}}$     | I2C current     | I2C idle current, clock enabled     |     | 6.25 |     | $\mu\text{A}/\text{MHz}$ |
| $I_{\text{TIMER}}$   | TIMER current   | TIMER_0 idle current, clock enabled |     | 8.75 |     | $\mu\text{A}/\text{MHz}$ |
| $I_{\text{LETIMER}}$ | LETIMER current | LETIMER idle current, clock enabled |     | 150  |     | nA                       |
| $I_{\text{PCNT}}$    | PCNT current    | PCNT idle current, clock enabled    |     | 100  |     | nA                       |
| $I_{\text{RTC}}$     | RTC current     | RTC idle current, clock enabled     |     | 100  |     | nA                       |
| $I_{\text{LCD}}$     | LCD current     | LCD idle current, clock enabled     |     | 100  |     | nA                       |
| $I_{\text{AES}}$     | AES current     | AES idle current, clock enabled     |     | 2.5  |     | $\mu\text{A}/\text{MHz}$ |
| $I_{\text{GPIO}}$    | GPIO current    | GPIO idle current, clock enabled    |     | 5.31 |     | $\mu\text{A}/\text{MHz}$ |
| $I_{\text{EBI}}$     | EBI current     | EBI idle current, clock enabled     |     | 1.56 |     | $\mu\text{A}/\text{MHz}$ |
| $I_{\text{PRS}}$     | PRS current     | PRS idle current                    |     | 2,81 |     | $\mu\text{A}/\text{MHz}$ |
| $I_{\text{DMA}}$     | DMA current     | Clock enable                        |     | 8.12 |     | $\mu\text{A}/\text{MHz}$ |

# 4 Pinout and Package

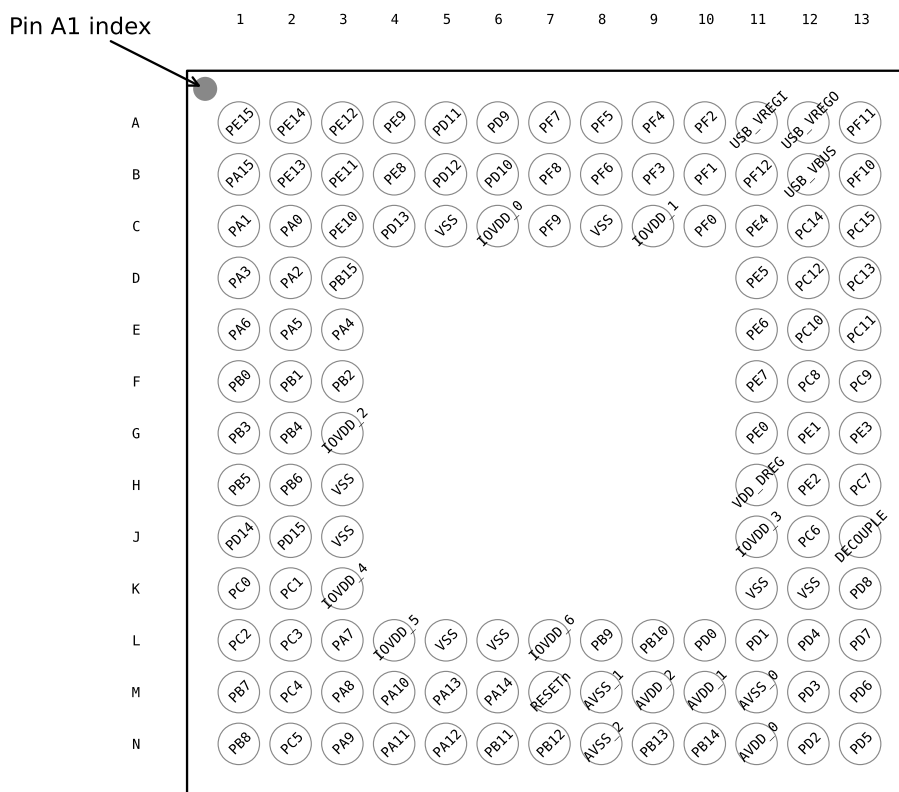
**Note**

Please refer to the application note "AN0002 EFM32 Hardware Design Considerations" for guidelines on designing Printed Circuit Boards (PCB's) for the EFM32WG995.

## 4.1 Pinout

The EFM32WG995 pinout is shown in Figure 4.1 (p. 54) and Table 4.1 (p. 54). Alternate locations are denoted by "#" followed by the location number (Multiple locations on the same pin are split with "/"). Alternate locations can be configured in the LOCATION bitfield in the \*\_ROUTE register in the module in question.

**Figure 4.1. EFM32WG995 Pinout (top view, not to scale)**



**Table 4.1. Device Pinout**

| BGA120 Pin# and Name |          | Pin Alternate Functionality / Description |                 |             |  |                              |
|----------------------|----------|---|-----------------|-------------|--|------------------------------|
| Pin #                | Pin Name | Analog                                    | EBI             | Timers      | Communication                          | Other                        |
| A1                   | PE15     | LCD_SEG11                                 | EBI_AD07 #0/1/2 | TIM3_CC1 #0 | LEU0_RX #2                             |                              |
| A2                   | PE14     | LCD_SEG10                                 | EBI_AD06 #0/1/2 | TIM3_CC0 #0 | LEU0_TX #2                             |                              |
| A3                   | PE12     | LCD_SEG8                                  | EBI_AD04 #0/1/2 | TIM1_CC2 #1 | US0_RX #3<br>US0_CLK #0<br>I2C0_SDA #6 | CMU_CLK1 #2<br>LES_ALTEX6 #0 |

| BGA120 Pin# and Name |           | Pin Alternate Functionality / Description                             |                 |                               |  |  |
|----------------------|-----------|---|-----------------|-------------------------------|--|--|
| Pin #                | Pin Name  | Analog  | EBI             | Timers                        | Communication                          | Other                                      |
| A4                   | PE9       | LCD_SEG5  | EBI_AD01 #0/1/2 | PCNT2_S1IN #1                 |  |  |
| A5                   | PD11      | LCD_SEG30   | EBI_CS2 #0/1/2  |                               |  |  |
| A6                   | PD9       | LCD_SEG28   | EBI_CS0 #0/1/2  |                               |  |  |
| A7                   | PF7       | LCD_SEG25   | EBI_BL1 #0/1/2  | TIM0_CC1 #2                   | U0_RX #0                               |  |
| A8                   | PF5       | LCD_SEG3  | EBI_REn #0/2    | TIM0_CDT12 #2/5               | USB_VBUSEN #0                          | PRS_CH2 #1                                 |
| A9                   | PF4       | LCD_SEG2  | EBI_WEn #0/2    | TIM0_CDT11 #2/5               |  | PRS_CH1 #1                                 |
| A10                  | PF2       | LCD_SEG0  | EBI_ARDY #0/1/2 | TIM0_CC2 #5                   | LEU0_TX #4                             | ACMP1_O #0<br>DBG_SWO #0<br>GPIO_EM4WU4    |
| A11                  | USB_VREGI | USB Input to internal 3.3 V regulator.                                |                 |                               |  |  |
| A12                  | USB_VREGO | USB Decoupling for internal 3.3 V USB regulator and regulator output. |                 |                               |  |  |
| A13                  | PF11      |   |                 |                               | U1_RX #1<br>USB_DP                     |  |
| B1                   | PA15      | LCD_SEG12   | EBI_AD08 #0/1/2 | TIM3_CC2 #0                   |  |  |
| B2                   | PE13      | LCD_SEG9  | EBI_AD05 #0/1/2 |                               | US0_TX #3<br>US0_CS #0<br>I2C0_SCL #6  | LES_ALTEX7 #0<br>ACMP0_O #0<br>GPIO_EM4WU5 |
| B3                   | PE11      | LCD_SEG7  | EBI_AD03 #0/1/2 | TIM1_CC1 #1                   | US0_RX #0                              | LES_ALTEX5 #0<br>BOOT_RX                   |
| B4                   | PE8       | LCD_SEG4  | EBI_AD00 #0/1/2 | PCNT2_S0IN #1                 |  | PRS_CH3 #1                                 |
| B5                   | PD12      | LCD_SEG31   | EBI_CS3 #0/1/2  |                               |  |  |
| B6                   | PD10      | LCD_SEG29   | EBI_CS1 #0/1/2  |                               |  |  |
| B7                   | PF8       | LCD_SEG26   | EBI_WEn #1      | TIM0_CC2 #2                   |  | ETM_TCLK #1                                |
| B8                   | PF6       | LCD_SEG24   | EBI_BLO #0/1/2  | TIM0_CC0 #2                   | U0_TX #0                               |  |
| B9                   | PF3       | LCD_SEG1  | EBI_ALE #0      | TIM0_CDT10 #2/5               |  | PRS_CH0 #1<br>ETM_TD3 #1                   |
| B10                  | PF1       |   |                 | TIM0_CC1 #5<br>LETIM0_OUT1 #2 | US1_CS #2<br>LEU0_RX #3<br>I2C0_SCL #5 | DBG_SWDIO #0/1/2/3<br>GPIO_EM4WU3          |
| B11                  | PF12      |   |                 |                               | USB_ID                                 |  |
| B12                  | USB_VBUS  | USB 5.0 V VBUS input.   |                 |                               |  |  |
| B13                  | PF10      |   |                 |                               | U1_TX #1<br>USB_DM                     |  |
| C1                   | PA1       | LCD_SEG14   | EBI_AD10 #0/1/2 | TIM0_CC1 #0/1                 | I2C0_SCL #0                            | CMU_CLK1 #0<br>PRS_CH1 #0                  |
| C2                   | PA0       | LCD_SEG13   | EBI_AD09 #0/1/2 | TIM0_CC0 #0/1/4               | LEU0_RX #4<br>I2C0_SDA #0              | PRS_CH0 #0<br>GPIO_EM4WU0                  |
| C3                   | PE10      | LCD_SEG6  | EBI_AD02 #0/1/2 | TIM1_CC0 #1                   | US0_TX #0                              | BOOT_TX                                    |
| C4                   | PD13      |   |                 |                               |  | ETM_TD1 #1                                 |
| C5                   | VSS       | Ground  |                 |                               |  |  |
| C6                   | IOVDD_0   | Digital IO power supply 0.  |                 |                               |  |  |
| C7                   | PF9       | LCD_SEG27   | EBI_REn #1      |                               |  | ETM_TD0 #1                                 |
| C8                   | VSS       | Ground  |                 |                               |  |  |
| C9                   | IOVDD_1   | Digital IO power supply 1.  |                 |                               |  |  |
| C10                  | PF0       |   |                 | TIM0_CC0 #5<br>LETIM0_OUT0 #2 | US1_CLK #2<br>LEU0_TX #3               | DBG_SWCLK #0/1/2/3                         |

| BGA120 Pin# and Name |          | Pin Alternate Functionality / Description      |                 |  |                         |                             |
|----------------------|----------|--|-----------------|--|-------------------------|-----------------------------|
| Pin #                | Pin Name | Analog   | EBI             | Timers   | Communication           | Other                       |
|                      |          |  |                 |  | I2C0_SDA #5             |                             |
| C11                  | PE4      | LCD_COM0                                       | EBI_A11 #0/1/2  |  | US0_CS #1               |                             |
| C12                  | PC14     | ACMP1_CH6<br>DAC0_OUT1ALT #2/<br>OPAMP_OUT1ALT |                 | TIM0_CDT11 #1/3<br>TIM1_CC1 #0<br>PCNT0_S1IN #0                | US0_CS #3<br>U0_TX #3   | LES_CH14 #0                 |
| C13                  | PC15     | ACMP1_CH7<br>DAC0_OUT1ALT #3/<br>OPAMP_OUT1ALT |                 | TIM0_CDT12 #1/3<br>TIM1_CC2 #0                                 | US0_CLK #3<br>U0_RX #3  | LES_CH15 #0<br>DBG_SWO #1   |
| D1                   | PA3      | LCD_SEG16                                      | EBI_AD12 #0/1/2 | TIM0_CDTI0 #0  | U0_TX #2                | LES_ALTEX2 #0<br>ETM_TD1 #3 |
| D2                   | PA2      | LCD_SEG15                                      | EBI_AD11 #0/1/2 | TIM0_CC2 #0/1  |                         | CMU_CLK0 #0<br>ETM_TD0 #3   |
| D3                   | PB15     |  |                 |  |                         | ETM_TD2 #1                  |
| D11                  | PE5      | LCD_COM1                                       | EBI_A12 #0/1/2  |  | US0_CLK #1              |                             |
| D12                  | PC12     | ACMP1_CH4<br>DAC0_OUT1ALT #0/<br>OPAMP_OUT1ALT |                 |  | U1_TX #0                | CMU_CLK0 #1<br>LES_CH12 #0  |
| D13                  | PC13     | ACMP1_CH5<br>DAC0_OUT1ALT #1/<br>OPAMP_OUT1ALT |                 | TIM0_CDTI0 #1/3<br>TIM1_CC0 #0<br>TIM1_CC2 #4<br>PCNT0_S0IN #0 | U1_RX #0                | LES_CH13 #0                 |
| E1                   | PA6      | LCD_SEG19                                      | EBI_AD15 #0/1/2 |  | LEU1_RX #1              | ETM_TCLK #3<br>GPIO_EM4WU1  |
| E2                   | PA5      | LCD_SEG18                                      | EBI_AD14 #0/1/2 | TIM0_CDTI2 #0  | LEU1_TX #1              | LES_ALTEX4 #0<br>ETM_TD3 #3 |
| E3                   | PA4      | LCD_SEG17                                      | EBI_AD13 #0/1/2 | TIM0_CDTI1 #0  | U0_RX #2                | LES_ALTEX3 #0<br>ETM_TD2 #3 |
| E11                  | PE6      | LCD_COM2                                       | EBI_A13 #0/1/2  |  | US0_RX #1               |                             |
| E12                  | PC10     | ACMP1_CH2                                      | EBI_A10 #1/2    | TIM2_CC2 #2  | US0_RX #2               | LES_CH10 #0                 |
| E13                  | PC11     | ACMP1_CH3                                      | EBI_ALE #1/2    |  | US0_TX #2               | LES_CH11 #0                 |
| F1                   | PB0      | LCD_SEG32                                      | EBI_A16 #0/1/2  | TIM1_CC0 #2  |                         |                             |
| F2                   | PB1      | LCD_SEG33                                      | EBI_A17 #0/1/2  | TIM1_CC1 #2  |                         |                             |
| F3                   | PB2      | LCD_SEG34                                      | EBI_A18 #0/1/2  | TIM1_CC2 #2  |                         |                             |
| F11                  | PE7      | LCD_COM3                                       | EBI_A14 #0/1/2  |  | US0_TX #1               |                             |
| F12                  | PC8      | ACMP1_CH0                                      | EBI_A15 #0/1/2  | TIM2_CC0 #2  | US0_CS #2               | LES_CH8 #0                  |
| F13                  | PC9      | ACMP1_CH1                                      | EBI_A09 #1/2    | TIM2_CC1 #2  | US0_CLK #2              | LES_CH9 #0<br>GPIO_EM4WU2   |
| G1                   | PB3      | LCD_SEG20/<br>LCD_COM4                         | EBI_A19 #0/1/2  | PCNT1_S0IN #1  | US2_TX #1               |                             |
| G2                   | PB4      | LCD_SEG21/<br>LCD_COM5                         | EBI_A20 #0/1/2  | PCNT1_S1IN #1  | US2_RX #1               |                             |
| G3                   | IOVDD_2  | Digital IO power supply 2.                     |                 |  |                         |                             |
| G11                  | PE0      |  | EBI_A07 #0/1/2  | TIM3_CC0 #1<br>PCNT0_S0IN #1                                   | U0_TX #1<br>I2C1_SDA #2 |                             |
| G12                  | PE1      |  | EBI_A08 #0/1/2  | TIM3_CC1 #1<br>PCNT0_S1IN #1                                   | U0_RX #1<br>I2C1_SCL #2 |                             |
| G13                  | PE3      | BU_STAT  | EBI_A10 #0      |  | U1_RX #3                | ACMP1_O #1                  |
| H1                   | PB5      | LCD_SEG22/<br>LCD_COM6                         | EBI_A21 #0/1/2  |  | US2_CLK #1              |                             |
| H2                   | PB6      | LCD_SEG23/                                     | EBI_A22 #0/1/2  |  | US2_CS #1               |                             |



| BGA120 Pin# and Name |          | Pin Alternate Functionality / Description   |                    |  |                                       |   |
|----------------------|----------|---|--------------------|--|---------------------------------------|---|
| Pin #                | Pin Name | Analog  | EBI                | Timers   | Communication                         | Other   |
|                      |          | LCD_COM7  |                    |  |                                       |   |
| H3                   | VSS      | Ground  |                    |  |                                       |   |
| H11                  | VDD_DREG | Power supply for on-chip voltage regulator.   |                    |  |                                       |   |
| H12                  | PE2      | BU_VOUT   | EBI_A09 #0         | TIM3_CC2 #1                                    | U1_TX #3                              | ACMP0_O #1  |
| H13                  | PC7      | ACMP0_CH7   | EBI_A06 #0/1/2     |  | LEU1_RX #0<br>I2C0_SCL #2             | LES_CH7 #0<br>ETM_TD0 #2                                  |
| J1                   | PD14     |   |                    |  | I2C0_SDA #3                           |   |
| J2                   | PD15     |   |                    |  | I2C0_SCL #3                           |   |
| J3                   | VSS      | Ground  |                    |  |                                       |   |
| J11                  | IOVDD_3  | Digital IO power supply 3.  |                    |  |                                       |   |
| J12                  | PC6      | ACMP0_CH6   | EBI_A05 #0/1/2     |  | LEU1_TX #0<br>I2C0_SDA #2             | LES_CH6 #0<br>ETM_TCLK #2                                 |
| J13                  | DECOUPLE | Decouple output for on-chip voltage regulator. An external capacitance of size C <sub>DECOUPLE</sub> is required at this pin. |                    |  |                                       |   |
| K1                   | PC0      | ACMP0_CH0<br>DAC0_OUT0ALT #0/<br>OPAMP_OUT0ALT  | EBI_A23 #0/1/2     | TIM0_CC1 #4<br>PCNT0_S0IN #2                   | US0_TX #5<br>US1_TX #0<br>I2C0_SDA #4 | LES_CH0 #0<br>PRS_CH2 #0                                  |
| K2                   | PC1      | ACMP0_CH1<br>DAC0_OUT0ALT #1/<br>OPAMP_OUT0ALT  | EBI_A24 #0/1/2     | TIM0_CC2 #4<br>PCNT0_S1IN #2                   | US0_RX #5<br>US1_RX #0<br>I2C0_SCL #4 | LES_CH1 #0<br>PRS_CH3 #0                                  |
| K3                   | IOVDD_4  | Digital IO power supply 4.  |                    |  |                                       |   |
| K11                  | VSS      | Ground  |                    |  |                                       |   |
| K12                  | VSS      | Ground  |                    |  |                                       |   |
| K13                  | PD8      | BU_VIN  |                    |  |                                       | CMU_CLK1 #1   |
| L1                   | PC2      | ACMP0_CH2<br>DAC0_OUT0ALT #2/<br>OPAMP_OUT0ALT  | EBI_A25 #0/1/2     | TIM0_CDTI0 #4                                  | US2_TX #0                             | LES_CH2 #0  |
| L2                   | PC3      | ACMP0_CH3<br>DAC0_OUT0ALT #3/<br>OPAMP_OUT0ALT  | EBI_NANDREn #0/1/2 | TIM0_CDTI1 #4                                  | US2_RX #0                             | LES_CH3 #0  |
| L3                   | PA7      | LCD_SEG35   | EBI_CSTFT #0/1/2   |  |                                       |   |
| L4                   | IOVDD_5  | Digital IO power supply 5.  |                    |  |                                       |   |
| L5                   | VSS      | Ground  |                    |  |                                       |   |
| L6                   | VSS      | Ground  |                    |  |                                       |   |
| L7                   | IOVDD_6  | Digital IO power supply 6.  |                    |  |                                       |   |
| L8                   | PB9      |   | EBI_A03 #0/1/2     |  | U1_TX #2                              |   |
| L9                   | PB10     |   | EBI_A04 #0/1/2     |  | U1_RX #2                              |   |
| L10                  | PD0      | ADC0_CH0<br>DAC0_OUT0ALT #4/<br>OPAMP_OUT0ALT<br>OPAMP_OUT2 #1  |                    | PCNT2_S0IN #0                                  | US1_TX #1                             |   |
| L11                  | PD1      | ADC0_CH1<br>DAC0_OUT1ALT #4/<br>OPAMP_OUT1ALT   |                    | TIM0_CC0 #3<br>PCNT2_S1IN #0                   | US1_RX #1                             | DBG_SWO #2  |
| L12                  | PD4      | ADC0_CH4<br>OPAMP_P2  |                    |  | LEU0_TX #0                            | ETM_TD2 #0/2  |
| L13                  | PD7      | ADC0_CH7<br>DAC0_N1 /<br>OPAMP_N1   |                    | TIM1_CC1 #4<br>LETIM0_OUT1 #0<br>PCNT0_S1IN #3 | US1_TX #2<br>I2C0_SCL #1              | CMU_CLK0 #2<br>LES_ALTEX1 #0<br>ACMP1_O #2<br>ETM_TCLK #0 |

| BGA120 Pin# and Name |          | Pin Alternate Functionality / Description  |                    |  |                            |   |
|----------------------|----------|--|--------------------|--|----------------------------|---|
| Pin #                | Pin Name | Analog   | EBI                | Timers   | Communication              | Other                                     |
| M1                   | PB7      | LFXTAL_P   |                    | TIM1_CC0 #3                                      | US0_TX #4<br>US1_CLK #0    |   |
| M2                   | PC4      | ACMP0_CH4<br>DAC0_P0 /<br>OPAMP_P0   | EBI_A26 #0/1/2     | TIM0_CDTI2 #4<br>LETIM0_OUT0 #3<br>PCNT1_S0IN #0 | US2_CLK #0<br>I2C1_SDA #0  | LES_CH4 #0                                |
| M3                   | PA8      | LCD_SEG36  | EBI_DCLK #0/1/2    | TIM2_CC0 #0                                      |                            |   |
| M4                   | PA10     | LCD_SEG38  | EBI_VSNCR #0/1/2   | TIM2_CC2 #0                                      |                            |   |
| M5                   | PA13     | LCD_BCAPP_N  | EBI_A01 #0/1/2     | TIM2_CC1 #1                                      |                            |   |
| M6                   | PA14     | LCD_BEXT   | EBI_A02 #0/1/2     | TIM2_CC2 #1                                      |                            |   |
| M7                   | RESETn   | Reset input, active low.<br>To apply an external reset source to this pin, it is required to only drive this pin low during reset, and let the internal pull-up ensure that reset is released. |                    |  |                            |   |
| M8                   | AVSS_1   | Analog ground 1.   |                    |  |                            |   |
| M9                   | AVDD_2   | Analog power supply 2.   |                    |  |                            |   |
| M10                  | AVDD_1   | Analog power supply 1.   |                    |  |                            |   |
| M11                  | AVSS_0   | Analog ground 0.   |                    |  |                            |   |
| M12                  | PD3      | ADC0_CH3<br>OPAMP_N2   |                    | TIM0_CC2 #3                                      | US1_CS #1                  | ETM_TD1 #0/2                              |
| M13                  | PD6      | ADC0_CH6<br>DAC0_P1 /<br>OPAMP_P1  |                    | TIM1_CC0 #4<br>LETIM0_OUT0 #0<br>PCNT0_S0IN #3   | US1_RX #2<br>I2C0_SDA #1   | LES_ALTEX0 #0<br>ACMP0_O #2<br>ETM_TD0 #0 |
| N1                   | PB8      | LFXTAL_N   |                    | TIM1_CC1 #3                                      | US0_RX #4<br>US1_CS #0     |   |
| N2                   | PC5      | ACMP0_CH5<br>DAC0_N0 /<br>OPAMP_N0   | EBI_NANDWEn #0/1/2 | LETIM0_OUT1 #3<br>PCNT1_S1IN #0                  | US2_CS #0<br>I2C1_SCL #0   | LES_CH5 #0                                |
| N3                   | PA9      | LCD_SEG37  | EBI_DTEN #0/1/2    | TIM2_CC1 #0                                      |                            |   |
| N4                   | PA11     | LCD_SEG39  | EBI_HSNC #0/1/2    |  |                            |   |
| N5                   | PA12     | LCD_BCAPP_P  | EBI_A00 #0/1/2     | TIM2_CC0 #1                                      |                            |   |
| N6                   | PB11     | DAC0_OUT0 /<br>OPAMP_OUT0  |                    | TIM1_CC2 #3<br>LETIM0_OUT0 #1                    | I2C1_SDA #1                |   |
| N7                   | PB12     | DAC0_OUT1 /<br>OPAMP_OUT1  |                    | LETIM0_OUT1 #1                                   | I2C1_SCL #1                |   |
| N8                   | AVSS_2   | Analog ground 2.   |                    |  |                            |   |
| N9                   | PB13     | HFXTAL_P   |                    |  | US0_CLK #4/5<br>LEU0_TX #1 |   |
| N10                  | PB14     | HFXTAL_N   |                    |  | US0_CS #4/5<br>LEU0_RX #1  |   |
| N11                  | AVDD_0   | Analog power supply 0.   |                    |  |                            |   |
| N12                  | PD2      | ADC0_CH2   | EBI_A27 #0/1/2     | TIM0_CC1 #3                                      | USB_DMPU #0<br>US1_CLK #1  | DBG_SWO #3                                |
| N13                  | PD5      | ADC0_CH5<br>OPAMP_OUT2 #0  |                    |  | LEU0_RX #0                 | ETM_TD3 #0/2                              |

## 4.2 Alternate Functionality Pinout

A wide selection of alternate functionality is available for multiplexing to various pins. This is shown in Table 4.2 (p. 59). The table shows the name of the alternate functionality in the first column, followed by columns showing the possible LOCATION bitfield settings.

**Note**

Some functionality, such as analog interfaces, do not have alternate settings or a LOCATION bitfield. In these cases, the pinout is shown in the column corresponding to LOCATION 0.

**Table 4.2. Alternate functionality overview**

| Alternate<br>Functionality | LOCATION |      |      |   |   |   |   | Description   |
|----------------------------|----------|------|------|---|---|---|---|---|
|                            | 0        | 1    | 2    | 3 | 4 | 5 | 6 |   |
| ACMP0_CH0                  | PC0      |      |      |   |   |   |   | Analog comparator ACMP0, channel 0.                                     |
| ACMP0_CH1                  | PC1      |      |      |   |   |   |   | Analog comparator ACMP0, channel 1.                                     |
| ACMP0_CH2                  | PC2      |      |      |   |   |   |   | Analog comparator ACMP0, channel 2.                                     |
| ACMP0_CH3                  | PC3      |      |      |   |   |   |   | Analog comparator ACMP0, channel 3.                                     |
| ACMP0_CH4                  | PC4      |      |      |   |   |   |   | Analog comparator ACMP0, channel 4.                                     |
| ACMP0_CH5                  | PC5      |      |      |   |   |   |   | Analog comparator ACMP0, channel 5.                                     |
| ACMP0_CH6                  | PC6      |      |      |   |   |   |   | Analog comparator ACMP0, channel 6.                                     |
| ACMP0_CH7                  | PC7      |      |      |   |   |   |   | Analog comparator ACMP0, channel 7.                                     |
| ACMP0_O                    | PE13     | PE2  | PD6  |   |   |   |   | Analog comparator ACMP0, digital output.                                |
| ACMP1_CH0                  | PC8      |      |      |   |   |   |   | Analog comparator ACMP1, channel 0.                                     |
| ACMP1_CH1                  | PC9      |      |      |   |   |   |   | Analog comparator ACMP1, channel 1.                                     |
| ACMP1_CH2                  | PC10     |      |      |   |   |   |   | Analog comparator ACMP1, channel 2.                                     |
| ACMP1_CH3                  | PC11     |      |      |   |   |   |   | Analog comparator ACMP1, channel 3.                                     |
| ACMP1_CH4                  | PC12     |      |      |   |   |   |   | Analog comparator ACMP1, channel 4.                                     |
| ACMP1_CH5                  | PC13     |      |      |   |   |   |   | Analog comparator ACMP1, channel 5.                                     |
| ACMP1_CH6                  | PC14     |      |      |   |   |   |   | Analog comparator ACMP1, channel 6.                                     |
| ACMP1_CH7                  | PC15     |      |      |   |   |   |   | Analog comparator ACMP1, channel 7.                                     |
| ACMP1_O                    | PF2      | PE3  | PD7  |   |   |   |   | Analog comparator ACMP1, digital output.                                |
| ADC0_CH0                   | PD0      |      |      |   |   |   |   | Analog to digital converter ADC0, input channel number 0.               |
| ADC0_CH1                   | PD1      |      |      |   |   |   |   | Analog to digital converter ADC0, input channel number 1.               |
| ADC0_CH2                   | PD2      |      |      |   |   |   |   | Analog to digital converter ADC0, input channel number 2.               |
| ADC0_CH3                   | PD3      |      |      |   |   |   |   | Analog to digital converter ADC0, input channel number 3.               |
| ADC0_CH4                   | PD4      |      |      |   |   |   |   | Analog to digital converter ADC0, input channel number 4.               |
| ADC0_CH5                   | PD5      |      |      |   |   |   |   | Analog to digital converter ADC0, input channel number 5.               |
| ADC0_CH6                   | PD6      |      |      |   |   |   |   | Analog to digital converter ADC0, input channel number 6.               |
| ADC0_CH7                   | PD7      |      |      |   |   |   |   | Analog to digital converter ADC0, input channel number 7.               |
| BOOT_RX                    | PE11     |      |      |   |   |   |   | Bootloader RX   |
| BOOT_TX                    | PE10     |      |      |   |   |   |   | Bootloader TX   |
| BU_STAT                    | PE3      |      |      |   |   |   |   | Backup Power Domain status, whether or not the system is in backup mode |
| BU_VIN                     | PD8      |      |      |   |   |   |   | Battery input for Backup Power Domain                                   |
| BU_VOUT                    | PE2      |      |      |   |   |   |   | Power output for Backup Power Domain                                    |
| CMU_CLK0                   | PA2      | PC12 | PD7  |   |   |   |   | Clock Management Unit, clock output number 0.                           |
| CMU_CLK1                   | PA1      | PD8  | PE12 |   |   |   |   | Clock Management Unit, clock output number 1.                           |
| DAC0_N0 /<br>OPAMP_N0      | PC5      |      |      |   |   |   |   | Operational Amplifier 0 external negative input.                        |
| DAC0_N1 /<br>OPAMP_N1      | PD7      |      |      |   |   |   |   | Operational Amplifier 1 external negative input.                        |

| Alternate                    | LOCATION |      |      |      |     |   |   | Description   |
|------------------------------|----------|------|------|------|-----|---|---|---|
|                              | 0        | 1    | 2    | 3    | 4   | 5 | 6 |   |
| OPAMP_N2                     | PD3      |      |      |      |     |   |   | Operational Amplifier 2 external negative input.  |
| DAC0_OUT0 / OPAMP_OUT0       | PB11     |      |      |      |     |   |   | Digital to Analog Converter DAC0_OUT0 / OPAMP output channel number 0.  |
| DAC0_OUT0ALT / OPAMP_OUT0ALT | PC0      | PC1  | PC2  | PC3  | PD0 |   |   | Digital to Analog Converter DAC0_OUT0ALT / OPAMP alternative output for channel 0.  |
| DAC0_OUT1 / OPAMP_OUT1       | PB12     |      |      |      |     |   |   | Digital to Analog Converter DAC0_OUT1 / OPAMP output channel number 1.  |
| DAC0_OUT1ALT / OPAMP_OUT1ALT | PC12     | PC13 | PC14 | PC15 | PD1 |   |   | Digital to Analog Converter DAC0_OUT1ALT / OPAMP alternative output for channel 1.  |
| OPAMP_OUT2                   | PD5      | PD0  |      |      |     |   |   | Operational Amplifier 2 output.   |
| DAC0_P0 / OPAMP_P0           | PC4      |      |      |      |     |   |   | Operational Amplifier 0 external positive input.  |
| DAC0_P1 / OPAMP_P1           | PD6      |      |      |      |     |   |   | Operational Amplifier 1 external positive input.  |
| OPAMP_P2                     | PD4      |      |      |      |     |   |   | Operational Amplifier 2 external positive input.  |
| DBG_SWCLK                    | PF0      | PF0  | PF0  | PF0  |     |   |   | Debug-interface Serial Wire clock input.<br>Note that this function is enabled to pin out of reset, and has a built-in pull down.             |
| DBG_SWDIO                    | PF1      | PF1  | PF1  | PF1  |     |   |   | Debug-interface Serial Wire data input / output.<br>Note that this function is enabled to pin out of reset, and has a built-in pull up.       |
| DBG_SWO                      | PF2      | PC15 | PD1  | PD2  |     |   |   | Debug-interface Serial Wire viewer Output.<br>Note that this function is not enabled after reset, and must be enabled by software to be used. |
| EBI_A00                      | PA12     | PA12 | PA12 |      |     |   |   | External Bus Interface (EBI) address output pin 00.   |
| EBI_A01                      | PA13     | PA13 | PA13 |      |     |   |   | External Bus Interface (EBI) address output pin 01.   |
| EBI_A02                      | PA14     | PA14 | PA14 |      |     |   |   | External Bus Interface (EBI) address output pin 02.   |
| EBI_A03                      | PB9      | PB9  | PB9  |      |     |   |   | External Bus Interface (EBI) address output pin 03.   |
| EBI_A04                      | PB10     | PB10 | PB10 |      |     |   |   | External Bus Interface (EBI) address output pin 04.   |
| EBI_A05                      | PC6      | PC6  | PC6  |      |     |   |   | External Bus Interface (EBI) address output pin 05.   |
| EBI_A06                      | PC7      | PC7  | PC7  |      |     |   |   | External Bus Interface (EBI) address output pin 06.   |
| EBI_A07                      | PE0      | PE0  | PE0  |      |     |   |   | External Bus Interface (EBI) address output pin 07.   |
| EBI_A08                      | PE1      | PE1  | PE1  |      |     |   |   | External Bus Interface (EBI) address output pin 08.   |
| EBI_A09                      | PE2      | PC9  | PC9  |      |     |   |   | External Bus Interface (EBI) address output pin 09.   |
| EBI_A10                      | PE3      | PC10 | PC10 |      |     |   |   | External Bus Interface (EBI) address output pin 10.   |
| EBI_A11                      | PE4      | PE4  | PE4  |      |     |   |   | External Bus Interface (EBI) address output pin 11.   |
| EBI_A12                      | PE5      | PE5  | PE5  |      |     |   |   | External Bus Interface (EBI) address output pin 12.   |
| EBI_A13                      | PE6      | PE6  | PE6  |      |     |   |   | External Bus Interface (EBI) address output pin 13.   |
| EBI_A14                      | PE7      | PE7  | PE7  |      |     |   |   | External Bus Interface (EBI) address output pin 14.   |
| EBI_A15                      | PC8      | PC8  | PC8  |      |     |   |   | External Bus Interface (EBI) address output pin 15.   |
| EBI_A16                      | PB0      | PB0  | PB0  |      |     |   |   | External Bus Interface (EBI) address output pin 16.   |
| EBI_A17                      | PB1      | PB1  | PB1  |      |     |   |   | External Bus Interface (EBI) address output pin 17.   |
| EBI_A18                      | PB2      | PB2  | PB2  |      |     |   |   | External Bus Interface (EBI) address output pin 18.   |
| EBI_A19                      | PB3      | PB3  | PB3  |      |     |   |   | External Bus Interface (EBI) address output pin 19.   |
| EBI_A20                      | PB4      | PB4  | PB4  |      |     |   |   | External Bus Interface (EBI) address output pin 20.   |
| EBI_A21                      | PB5      | PB5  | PB5  |      |     |   |   | External Bus Interface (EBI) address output pin 21.   |

| Alternate | LOCATION |      |      |   |   |   |   | Description  |
|-----------|----------|------|------|---|---|---|---|--|
|           | 0        | 1    | 2    | 3 | 4 | 5 | 6 |  |
| EBI_A22   | PB6      | PB6  | PB6  |   |   |   |   | External Bus Interface (EBI) address output pin 22.                  |
| EBI_A23   | PC0      | PC0  | PC0  |   |   |   |   | External Bus Interface (EBI) address output pin 23.                  |
| EBI_A24   | PC1      | PC1  | PC1  |   |   |   |   | External Bus Interface (EBI) address output pin 24.                  |
| EBI_A25   | PC2      | PC2  | PC2  |   |   |   |   | External Bus Interface (EBI) address output pin 25.                  |
| EBI_A26   | PC4      | PC4  | PC4  |   |   |   |   | External Bus Interface (EBI) address output pin 26.                  |
| EBI_A27   | PD2      | PD2  | PD2  |   |   |   |   | External Bus Interface (EBI) address output pin 27.                  |
| EBI_AD00  | PE8      | PE8  | PE8  |   |   |   |   | External Bus Interface (EBI) address and data input / output pin 00. |
| EBI_AD01  | PE9      | PE9  | PE9  |   |   |   |   | External Bus Interface (EBI) address and data input / output pin 01. |
| EBI_AD02  | PE10     | PE10 | PE10 |   |   |   |   | External Bus Interface (EBI) address and data input / output pin 02. |
| EBI_AD03  | PE11     | PE11 | PE11 |   |   |   |   | External Bus Interface (EBI) address and data input / output pin 03. |
| EBI_AD04  | PE12     | PE12 | PE12 |   |   |   |   | External Bus Interface (EBI) address and data input / output pin 04. |
| EBI_AD05  | PE13     | PE13 | PE13 |   |   |   |   | External Bus Interface (EBI) address and data input / output pin 05. |
| EBI_AD06  | PE14     | PE14 | PE14 |   |   |   |   | External Bus Interface (EBI) address and data input / output pin 06. |
| EBI_AD07  | PE15     | PE15 | PE15 |   |   |   |   | External Bus Interface (EBI) address and data input / output pin 07. |
| EBI_AD08  | PA15     | PA15 | PA15 |   |   |   |   | External Bus Interface (EBI) address and data input / output pin 08. |
| EBI_AD09  | PA0      | PA0  | PA0  |   |   |   |   | External Bus Interface (EBI) address and data input / output pin 09. |
| EBI_AD10  | PA1      | PA1  | PA1  |   |   |   |   | External Bus Interface (EBI) address and data input / output pin 10. |
| EBI_AD11  | PA2      | PA2  | PA2  |   |   |   |   | External Bus Interface (EBI) address and data input / output pin 11. |
| EBI_AD12  | PA3      | PA3  | PA3  |   |   |   |   | External Bus Interface (EBI) address and data input / output pin 12. |
| EBI_AD13  | PA4      | PA4  | PA4  |   |   |   |   | External Bus Interface (EBI) address and data input / output pin 13. |
| EBI_AD14  | PA5      | PA5  | PA5  |   |   |   |   | External Bus Interface (EBI) address and data input / output pin 14. |
| EBI_AD15  | PA6      | PA6  | PA6  |   |   |   |   | External Bus Interface (EBI) address and data input / output pin 15. |
| EBI_ALE   | PF3      | PC11 | PC11 |   |   |   |   | External Bus Interface (EBI) Address Latch Enable output.            |
| EBI_ARDY  | PF2      | PF2  | PF2  |   |   |   |   | External Bus Interface (EBI) Hardware Ready Control input.           |
| EBI_BL0   | PF6      | PF6  | PF6  |   |   |   |   | External Bus Interface (EBI) Byte Lane/Enable pin 0.                 |
| EBI_BL1   | PF7      | PF7  | PF7  |   |   |   |   | External Bus Interface (EBI) Byte Lane/Enable pin 1.                 |
| EBI_CS0   | PD9      | PD9  | PD9  |   |   |   |   | External Bus Interface (EBI) Chip Select output 0.                   |
| EBI_CS1   | PD10     | PD10 | PD10 |   |   |   |   | External Bus Interface (EBI) Chip Select output 1.                   |
| EBI_CS2   | PD11     | PD11 | PD11 |   |   |   |   | External Bus Interface (EBI) Chip Select output 2.                   |
| EBI_CS3   | PD12     | PD12 | PD12 |   |   |   |   | External Bus Interface (EBI) Chip Select output 3.                   |
| EBI_CSTFT | PA7      | PA7  | PA7  |   |   |   |   | External Bus Interface (EBI) Chip Select output TFT.                 |
| EBI_DCLK  | PA8      | PA8  | PA8  |   |   |   |   | External Bus Interface (EBI) TFT Dot Clock pin.                      |
| EBI_DTEN  | PA9      | PA9  | PA9  |   |   |   |   | External Bus Interface (EBI) TFT Data Enable pin.                    |

| Alternate   | LOCATION |      |      |      |     |     |      | Description   |
|-------------|----------|------|------|------|-----|-----|------|---|
|             | 0        | 1    | 2    | 3    | 4   | 5   | 6    |   |
| EBI_HSNC    | PA11     | PA11 | PA11 |      |     |     |      | External Bus Interface (EBI) TFT Horizontal Synchronization pin.  |
| EBI_NANDREn | PC3      | PC3  | PC3  |      |     |     |      | External Bus Interface (EBI) NAND Read Enable output.   |
| EBI_NANDWEn | PC5      | PC5  | PC5  |      |     |     |      | External Bus Interface (EBI) NAND Write Enable output.  |
| EBI_REn     | PF5      | PF9  | PF5  |      |     |     |      | External Bus Interface (EBI) Read Enable output.  |
| EBI_VSNC    | PA10     | PA10 | PA10 |      |     |     |      | External Bus Interface (EBI) TFT Vertical Synchronization pin.  |
| EBI_WEn     | PF4      | PF8  | PF4  |      |     |     |      | External Bus Interface (EBI) Write Enable output.   |
| ETM_TCLK    | PD7      | PF8  | PC6  | PA6  |     |     |      | Embedded Trace Module ETM clock .   |
| ETM_TD0     | PD6      | PF9  | PC7  | PA2  |     |     |      | Embedded Trace Module ETM data 0.   |
| ETM_TD1     | PD3      | PD13 | PD3  | PA3  |     |     |      | Embedded Trace Module ETM data 1.   |
| ETM_TD2     | PD4      | PB15 | PD4  | PA4  |     |     |      | Embedded Trace Module ETM data 2.   |
| ETM_TD3     | PD5      | PF3  | PD5  | PA5  |     |     |      | Embedded Trace Module ETM data 3.   |
| GPIO_EM4WU0 | PA0      |      |      |      |     |     |      | Pin can be used to wake the system up from EM4  |
| GPIO_EM4WU1 | PA6      |      |      |      |     |     |      | Pin can be used to wake the system up from EM4  |
| GPIO_EM4WU2 | PC9      |      |      |      |     |     |      | Pin can be used to wake the system up from EM4  |
| GPIO_EM4WU3 | PF1      |      |      |      |     |     |      | Pin can be used to wake the system up from EM4  |
| GPIO_EM4WU4 | PF2      |      |      |      |     |     |      | Pin can be used to wake the system up from EM4  |
| GPIO_EM4WU5 | PE13     |      |      |      |     |     |      | Pin can be used to wake the system up from EM4  |
| HFX TAL_N   | PB14     |      |      |      |     |     |      | High Frequency Crystal negative pin. Also used as external optional clock input pin.  |
| HFX TAL_P   | PB13     |      |      |      |     |     |      | High Frequency Crystal positive pin.  |
| I2C0_SCL    | PA1      | PD7  | PC7  | PD15 | PC1 | PF1 | PE13 | I2C0 Serial Clock Line input / output.  |
| I2C0_SDA    | PA0      | PD6  | PC6  | PD14 | PC0 | PF0 | PE12 | I2C0 Serial Data input / output.  |
| I2C1_SCL    | PC5      | PB12 | PE1  |      |     |     |      | I2C1 Serial Clock Line input / output.  |
| I2C1_SDA    | PC4      | PB11 | PE0  |      |     |     |      | I2C1 Serial Data input / output.  |
| LCD_BCAP_N  | PA13     |      |      |      |     |     |      | LCD voltage booster (optional), boost capacitor, negative pin. If using the LCD voltage booster, connect a 22 nF capacitor between LCD_BCAP_N and LCD_BCAP_P.   |
| LCD_BCAP_P  | PA12     |      |      |      |     |     |      | LCD voltage booster (optional), boost capacitor, positive pin. If using the LCD voltage booster, connect a 22 nF capacitor between LCD_BCAP_N and LCD_BCAP_P.   |
| LCD_BEXT    | PA14     |      |      |      |     |     |      | LCD voltage booster (optional), boost output. If using the LCD voltage booster, connect a 1 uF capacitor between this pin and VSS.<br><br>An external LCD voltage may also be applied to this pin if the booster is not enabled.<br><br>If AVDD is used directly as the LCD supply voltage, this pin may be left unconnected or used as a GPIO. |
| LCD_COM0    | PE4      |      |      |      |     |     |      | LCD driver common line number 0.  |
| LCD_COM1    | PE5      |      |      |      |     |     |      | LCD driver common line number 1.  |
| LCD_COM2    | PE6      |      |      |      |     |     |      | LCD driver common line number 2.  |
| LCD_COM3    | PE7      |      |      |      |     |     |      | LCD driver common line number 3.  |
| LCD_SEG0    | PF2      |      |      |      |     |     |      | LCD segment line 0. Segments 0, 1, 2 and 3 are controlled by SEGEN0.  |
| LCD_SEG1    | PF3      |      |      |      |     |     |      | LCD segment line 1. Segments 0, 1, 2 and 3 are controlled by SEGEN0.  |
| LCD_SEG2    | PF4      |      |      |      |     |     |      | LCD segment line 2. Segments 0, 1, 2 and 3 are controlled by SEGEN0.  |

| Alternate              | LOCATION |   |   |   |   |   |   | Description   |
|------------------------|----------|---|---|---|---|---|---|---|
|                        | 0        | 1 | 2 | 3 | 4 | 5 | 6 |   |
| LCD_SEG3               | PF5      |   |   |   |   |   |   | LCD segment line 3. Segments 0, 1, 2 and 3 are controlled by SEGEN0.  |
| LCD_SEG4               | PE8      |   |   |   |   |   |   | LCD segment line 4. Segments 4, 5, 6 and 7 are controlled by SEGEN1.  |
| LCD_SEG5               | PE9      |   |   |   |   |   |   | LCD segment line 5. Segments 4, 5, 6 and 7 are controlled by SEGEN1.  |
| LCD_SEG6               | PE10     |   |   |   |   |   |   | LCD segment line 6. Segments 4, 5, 6 and 7 are controlled by SEGEN1.  |
| LCD_SEG7               | PE11     |   |   |   |   |   |   | LCD segment line 7. Segments 4, 5, 6 and 7 are controlled by SEGEN1.  |
| LCD_SEG8               | PE12     |   |   |   |   |   |   | LCD segment line 8. Segments 8, 9, 10 and 11 are controlled by SEGEN2.  |
| LCD_SEG9               | PE13     |   |   |   |   |   |   | LCD segment line 9. Segments 8, 9, 10 and 11 are controlled by SEGEN2.  |
| LCD_SEG10              | PE14     |   |   |   |   |   |   | LCD segment line 10. Segments 8, 9, 10 and 11 are controlled by SEGEN2.   |
| LCD_SEG11              | PE15     |   |   |   |   |   |   | LCD segment line 11. Segments 8, 9, 10 and 11 are controlled by SEGEN2.   |
| LCD_SEG12              | PA15     |   |   |   |   |   |   | LCD segment line 12. Segments 12, 13, 14 and 15 are controlled by SEGEN3.   |
| LCD_SEG13              | PA0      |   |   |   |   |   |   | LCD segment line 13. Segments 12, 13, 14 and 15 are controlled by SEGEN3.   |
| LCD_SEG14              | PA1      |   |   |   |   |   |   | LCD segment line 14. Segments 12, 13, 14 and 15 are controlled by SEGEN3.   |
| LCD_SEG15              | PA2      |   |   |   |   |   |   | LCD segment line 15. Segments 12, 13, 14 and 15 are controlled by SEGEN3.   |
| LCD_SEG16              | PA3      |   |   |   |   |   |   | LCD segment line 16. Segments 16, 17, 18 and 19 are controlled by SEGEN4.   |
| LCD_SEG17              | PA4      |   |   |   |   |   |   | LCD segment line 17. Segments 16, 17, 18 and 19 are controlled by SEGEN4.   |
| LCD_SEG18              | PA5      |   |   |   |   |   |   | LCD segment line 18. Segments 16, 17, 18 and 19 are controlled by SEGEN4.   |
| LCD_SEG19              | PA6      |   |   |   |   |   |   | LCD segment line 19. Segments 16, 17, 18 and 19 are controlled by SEGEN4.   |
| LCD_SEG20/<br>LCD_COM4 | PB3      |   |   |   |   |   |   | LCD segment line 20. Segments 20, 21, 22 and 23 are controlled by SEGEN5. This pin may also be used as LCD COM line 4 |
| LCD_SEG21/<br>LCD_COM5 | PB4      |   |   |   |   |   |   | LCD segment line 21. Segments 20, 21, 22 and 23 are controlled by SEGEN5. This pin may also be used as LCD COM line 5 |
| LCD_SEG22/<br>LCD_COM6 | PB5      |   |   |   |   |   |   | LCD segment line 22. Segments 20, 21, 22 and 23 are controlled by SEGEN5. This pin may also be used as LCD COM line 6 |
| LCD_SEG23/<br>LCD_COM7 | PB6      |   |   |   |   |   |   | LCD segment line 23. Segments 20, 21, 22 and 23 are controlled by SEGEN5. This pin may also be used as LCD COM line 7 |
| LCD_SEG24              | PF6      |   |   |   |   |   |   | LCD segment line 24. Segments 24, 25, 26 and 27 are controlled by SEGEN6.   |
| LCD_SEG25              | PF7      |   |   |   |   |   |   | LCD segment line 25. Segments 24, 25, 26 and 27 are controlled by SEGEN6.   |
| LCD_SEG26              | PF8      |   |   |   |   |   |   | LCD segment line 26. Segments 24, 25, 26 and 27 are controlled by SEGEN6.   |
| LCD_SEG27              | PF9      |   |   |   |   |   |   | LCD segment line 27. Segments 24, 25, 26 and 27 are controlled by SEGEN6.   |
| LCD_SEG28              | PD9      |   |   |   |   |   |   | LCD segment line 28. Segments 28, 29, 30 and 31 are controlled by SEGEN7.   |

| Alternate   | LOCATION |      |     |     |   |   |   | Description   |
|-------------|----------|------|-----|-----|---|---|---|---|
|             | 0        | 1    | 2   | 3   | 4 | 5 | 6 |   |
| LCD_SEG29   | PD10     |      |     |     |   |   |   | LCD segment line 29. Segments 28, 29, 30 and 31 are controlled by SEGEN7. |
| LCD_SEG30   | PD11     |      |     |     |   |   |   | LCD segment line 30. Segments 28, 29, 30 and 31 are controlled by SEGEN7. |
| LCD_SEG31   | PD12     |      |     |     |   |   |   | LCD segment line 31. Segments 28, 29, 30 and 31 are controlled by SEGEN7. |
| LCD_SEG32   | PB0      |      |     |     |   |   |   | LCD segment line 32. Segments 32, 33, 34 and 35 are controlled by SEGEN8. |
| LCD_SEG33   | PB1      |      |     |     |   |   |   | LCD segment line 33. Segments 32, 33, 34 and 35 are controlled by SEGEN8. |
| LCD_SEG34   | PB2      |      |     |     |   |   |   | LCD segment line 34. Segments 32, 33, 34 and 35 are controlled by SEGEN8. |
| LCD_SEG35   | PA7      |      |     |     |   |   |   | LCD segment line 35. Segments 32, 33, 34 and 35 are controlled by SEGEN8. |
| LCD_SEG36   | PA8      |      |     |     |   |   |   | LCD segment line 36. Segments 36, 37, 38 and 39 are controlled by SEGEN9. |
| LCD_SEG37   | PA9      |      |     |     |   |   |   | LCD segment line 37. Segments 36, 37, 38 and 39 are controlled by SEGEN9. |
| LCD_SEG38   | PA10     |      |     |     |   |   |   | LCD segment line 38. Segments 36, 37, 38 and 39 are controlled by SEGEN9. |
| LCD_SEG39   | PA11     |      |     |     |   |   |   | LCD segment line 39. Segments 36, 37, 38 and 39 are controlled by SEGEN9. |
| LES_ALTEX0  | PD6      |      |     |     |   |   |   | LESENSE alternate exit output 0.  |
| LES_ALTEX1  | PD7      |      |     |     |   |   |   | LESENSE alternate exit output 1.  |
| LES_ALTEX2  | PA3      |      |     |     |   |   |   | LESENSE alternate exit output 2.  |
| LES_ALTEX3  | PA4      |      |     |     |   |   |   | LESENSE alternate exit output 3.  |
| LES_ALTEX4  | PA5      |      |     |     |   |   |   | LESENSE alternate exit output 4.  |
| LES_ALTEX5  | PE11     |      |     |     |   |   |   | LESENSE alternate exit output 5.  |
| LES_ALTEX6  | PE12     |      |     |     |   |   |   | LESENSE alternate exit output 6.  |
| LES_ALTEX7  | PE13     |      |     |     |   |   |   | LESENSE alternate exit output 7.  |
| LES_CH0     | PC0      |      |     |     |   |   |   | LESENSE channel 0.  |
| LES_CH1     | PC1      |      |     |     |   |   |   | LESENSE channel 1.  |
| LES_CH2     | PC2      |      |     |     |   |   |   | LESENSE channel 2.  |
| LES_CH3     | PC3      |      |     |     |   |   |   | LESENSE channel 3.  |
| LES_CH4     | PC4      |      |     |     |   |   |   | LESENSE channel 4.  |
| LES_CH5     | PC5      |      |     |     |   |   |   | LESENSE channel 5.  |
| LES_CH6     | PC6      |      |     |     |   |   |   | LESENSE channel 6.  |
| LES_CH7     | PC7      |      |     |     |   |   |   | LESENSE channel 7.  |
| LES_CH8     | PC8      |      |     |     |   |   |   | LESENSE channel 8.  |
| LES_CH9     | PC9      |      |     |     |   |   |   | LESENSE channel 9.  |
| LES_CH10    | PC10     |      |     |     |   |   |   | LESENSE channel 10.   |
| LES_CH11    | PC11     |      |     |     |   |   |   | LESENSE channel 11.   |
| LES_CH12    | PC12     |      |     |     |   |   |   | LESENSE channel 12.   |
| LES_CH13    | PC13     |      |     |     |   |   |   | LESENSE channel 13.   |
| LES_CH14    | PC14     |      |     |     |   |   |   | LESENSE channel 14.   |
| LES_CH15    | PC15     |      |     |     |   |   |   | LESENSE channel 15.   |
| LETIM0_OUT0 | PD6      | PB11 | PF0 | PC4 |   |   |   | Low Energy Timer LETIM0, output channel 0.                                |



| Alternate   | LOCATION |      |      |      |      |      |   | Description   |
|-------------|----------|------|------|------|------|------|---|---|
|             | 0        | 1    | 2    | 3    | 4    | 5    | 6 |   |
| LETIM0_OUT1 | PD7      | PB12 | PF1  | PC5  |      |      |   | Low Energy Timer LETIM0, output channel 1.  |
| LEU0_RX     | PD5      | PB14 | PE15 | PF1  | PA0  |      |   | LEUART0 Receive input.  |
| LEU0_TX     | PD4      | PB13 | PE14 | PF0  | PF2  |      |   | LEUART0 Transmit output. Also used as receive input in half duplex communication.                             |
| LEU1_RX     | PC7      | PA6  |      |      |      |      |   | LEUART1 Receive input.  |
| LEU1_TX     | PC6      | PA5  |      |      |      |      |   | LEUART1 Transmit output. Also used as receive input in half duplex communication.                             |
| LFXTAL_N    | PB8      |      |      |      |      |      |   | Low Frequency Crystal (typically 32.768 kHz) negative pin. Also used as an optional external clock input pin. |
| LFXTAL_P    | PB7      |      |      |      |      |      |   | Low Frequency Crystal (typically 32.768 kHz) positive pin.  |
| PCNT0_S0IN  | PC13     | PE0  | PC0  | PD6  |      |      |   | Pulse Counter PCNT0 input number 0.   |
| PCNT0_S1IN  | PC14     | PE1  | PC1  | PD7  |      |      |   | Pulse Counter PCNT0 input number 1.   |
| PCNT1_S0IN  | PC4      | PB3  |      |      |      |      |   | Pulse Counter PCNT1 input number 0.   |
| PCNT1_S1IN  | PC5      | PB4  |      |      |      |      |   | Pulse Counter PCNT1 input number 1.   |
| PCNT2_S0IN  | PD0      | PE8  |      |      |      |      |   | Pulse Counter PCNT2 input number 0.   |
| PCNT2_S1IN  | PD1      | PE9  |      |      |      |      |   | Pulse Counter PCNT2 input number 1.   |
| PRS_CH0     | PA0      | PF3  |      |      |      |      |   | Peripheral Reflex System PRS, channel 0.  |
| PRS_CH1     | PA1      | PF4  |      |      |      |      |   | Peripheral Reflex System PRS, channel 1.  |
| PRS_CH2     | PC0      | PF5  |      |      |      |      |   | Peripheral Reflex System PRS, channel 2.  |
| PRS_CH3     | PC1      | PE8  |      |      |      |      |   | Peripheral Reflex System PRS, channel 3.  |
| TIM0_CC0    | PA0      | PA0  | PF6  | PD1  | PA0  | PF0  |   | Timer 0 Capture Compare input / output channel 0.   |
| TIM0_CC1    | PA1      | PA1  | PF7  | PD2  | PC0  | PF1  |   | Timer 0 Capture Compare input / output channel 1.   |
| TIM0_CC2    | PA2      | PA2  | PF8  | PD3  | PC1  | PF2  |   | Timer 0 Capture Compare input / output channel 2.   |
| TIM0_CDTI0  | PA3      | PC13 | PF3  | PC13 | PC2  | PF3  |   | Timer 0 Complimentary Deat Time Insertion channel 0.  |
| TIM0_CDTI1  | PA4      | PC14 | PF4  | PC14 | PC3  | PF4  |   | Timer 0 Complimentary Deat Time Insertion channel 1.  |
| TIM0_CDTI2  | PA5      | PC15 | PF5  | PC15 | PC4  | PF5  |   | Timer 0 Complimentary Deat Time Insertion channel 2.  |
| TIM1_CC0    | PC13     | PE10 | PB0  | PB7  | PD6  |      |   | Timer 1 Capture Compare input / output channel 0.   |
| TIM1_CC1    | PC14     | PE11 | PB1  | PB8  | PD7  |      |   | Timer 1 Capture Compare input / output channel 1.   |
| TIM1_CC2    | PC15     | PE12 | PB2  | PB11 | PC13 |      |   | Timer 1 Capture Compare input / output channel 2.   |
| TIM2_CC0    | PA8      | PA12 | PC8  |      |      |      |   | Timer 2 Capture Compare input / output channel 0.   |
| TIM2_CC1    | PA9      | PA13 | PC9  |      |      |      |   | Timer 2 Capture Compare input / output channel 1.   |
| TIM2_CC2    | PA10     | PA14 | PC10 |      |      |      |   | Timer 2 Capture Compare input / output channel 2.   |
| TIM3_CC0    | PE14     | PE0  |      |      |      |      |   | Timer 3 Capture Compare input / output channel 0.   |
| TIM3_CC1    | PE15     | PE1  |      |      |      |      |   | Timer 3 Capture Compare input / output channel 1.   |
| TIM3_CC2    | PA15     | PE2  |      |      |      |      |   | Timer 3 Capture Compare input / output channel 2.   |
| U0_RX       | PF7      | PE1  | PA4  | PC15 |      |      |   | UART0 Receive input.  |
| U0_TX       | PF6      | PE0  | PA3  | PC14 |      |      |   | UART0 Transmit output. Also used as receive input in half duplex communication.                               |
| U1_RX       | PC13     | PF11 | PB10 | PE3  |      |      |   | UART1 Receive input.  |
| U1_TX       | PC12     | PF10 | PB9  | PE2  |      |      |   | UART1 Transmit output. Also used as receive input in half duplex communication.                               |
| US0_CLK     | PE12     | PE5  | PC9  | PC15 | PB13 | PB13 |   | USART0 clock input / output.  |
| US0_CS      | PE13     | PE4  | PC8  | PC14 | PB14 | PB14 |   | USART0 chip select input / output.  |
| US0_RX      | PE11     | PE6  | PC10 | PE12 | PB8  | PC1  |   | USART0 Asynchronous Receive.  |

| Alternate     | LOCATION  |     |      |      |     |     |   |   |
|---------------|-----------|-----|------|------|-----|-----|---|---|
| Functionality | 0         | 1   | 2    | 3    | 4   | 5   | 6 | Description   |
|               |           |     |      |      |     |     |   | USART0 Synchronous mode Master Input / Slave Output (MISO).   |
| US0_TX        | PE10      | PE7 | PC11 | PE13 | PB7 | PC0 |   | USART0 Asynchronous Transmit. Also used as receive input in half duplex communication.<br>USART0 Synchronous mode Master Output / Slave Input (MOSI). |
| US1_CLK       | PB7       | PD2 | PF0  |      |     |     |   | USART1 clock input / output.  |
| US1_CS        | PB8       | PD3 | PF1  |      |     |     |   | USART1 chip select input / output.  |
| US1_RX        | PC1       | PD1 | PD6  |      |     |     |   | USART1 Asynchronous Receive.<br>USART1 Synchronous mode Master Input / Slave Output (MISO).   |
| US1_TX        | PC0       | PD0 | PD7  |      |     |     |   | USART1 Asynchronous Transmit. Also used as receive input in half duplex communication.<br>USART1 Synchronous mode Master Output / Slave Input (MOSI). |
| US2_CLK       | PC4       | PB5 |      |      |     |     |   | USART2 clock input / output.  |
| US2_CS        | PC5       | PB6 |      |      |     |     |   | USART2 chip select input / output.  |
| US2_RX        | PC3       | PB4 |      |      |     |     |   | USART2 Asynchronous Receive.<br>USART2 Synchronous mode Master Input / Slave Output (MISO).   |
| US2_TX        | PC2       | PB3 |      |      |     |     |   | USART2 Asynchronous Transmit. Also used as receive input in half duplex communication.<br>USART2 Synchronous mode Master Output / Slave Input (MOSI). |
| USB_DM        | PF10      |     |      |      |     |     |   | USB D- pin.   |
| USB_DMPU      | PD2       |     |      |      |     |     |   | USB D- Pullup control.  |
| USB_DP        | PF11      |     |      |      |     |     |   | USB D+ pin.   |
| USB_ID        | PF12      |     |      |      |     |     |   | USB ID pin. Used in OTG mode.   |
| USB_VBUS      | USB_VBUS  |     |      |      |     |     |   | USB 5 V VBUS input.   |
| USB_VBUSEN    | PF5       |     |      |      |     |     |   | USB 5 V VBUS enable.  |
| USB_VREGI     | USB_VREGI |     |      |      |     |     |   | USB Input to internal 3.3 V regulator   |
| USB_VREGO     | USB_VREGO |     |      |      |     |     |   | USB Decoupling for internal 3.3 V USB regulator and regulator output  |

### 4.3 GPIO Pinout Overview

The specific GPIO pins available in *EFM32WG995* is shown in Table 4.3 (p. 66). Each GPIO port is organized as 16-bit ports indicated by letters A through F, and the individual pin on this port in indicated by a number from 15 down to 0.

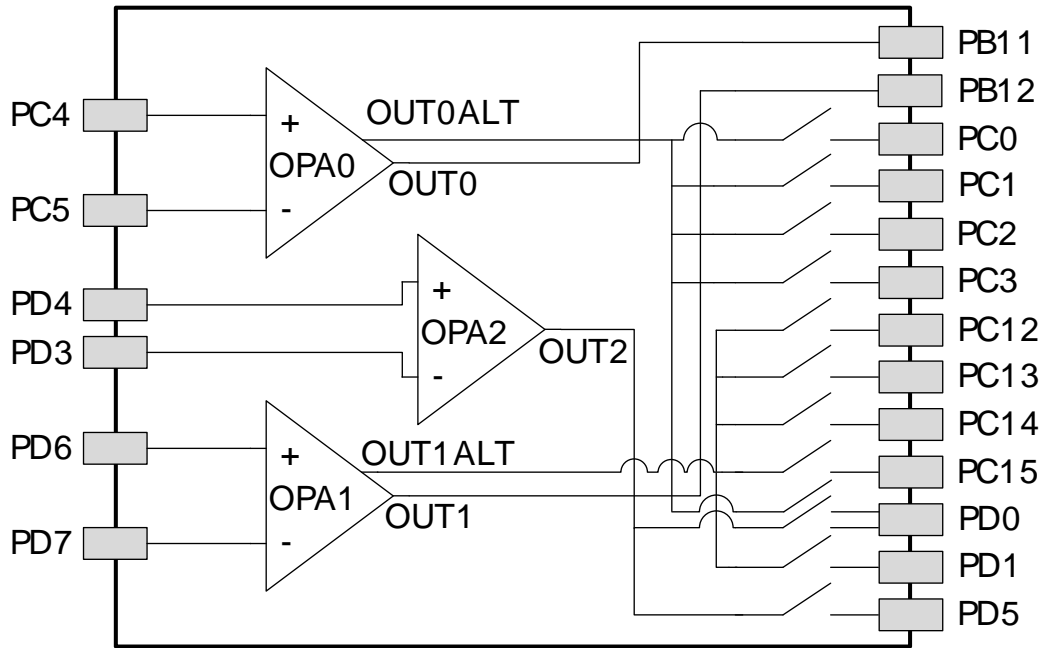
**Table 4.3. GPIO Pinout**

| Port   | Pin 15 | Pin 14 | Pin 13 | Pin 12 | Pin 11 | Pin 10 | Pin 9 | Pin 8 | Pin 7 | Pin 6 | Pin 5 | Pin 4 | Pin 3 | Pin 2 | Pin 1 | Pin 0 |
|--------|--------|--------|--------|--------|--------|--------|-------|-------|-------|-------|-------|-------|-------|-------|-------|-------|
| Port A | PA15   | PA14   | PA13   | PA12   | PA11   | PA10   | PA9   | PA8   | PA7   | PA6   | PA5   | PA4   | PA3   | PA2   | PA1   | PA0   |
| Port B | PB15   | PB14   | PB13   | PB12   | PB11   | PB10   | PB9   | PB8   | PB7   | PB6   | PB5   | PB4   | PB3   | PB2   | PB1   | PB0   |
| Port C | PC15   | PC14   | PC13   | PC12   | PC11   | PC10   | PC9   | PC8   | PC7   | PC6   | PC5   | PC4   | PC3   | PC2   | PC1   | PC0   |
| Port D | PD15   | PD14   | PD13   | PD12   | PD11   | PD10   | PD9   | PD8   | PD7   | PD6   | PD5   | PD4   | PD3   | PD2   | PD1   | PD0   |
| Port E | PE15   | PE14   | PE13   | PE12   | PE11   | PE10   | PE9   | PE8   | PE7   | PE6   | PE5   | PE4   | PE3   | PE2   | PE1   | PE0   |
| Port F | -      | -      | -      | PF12   | PF11   | PF10   | PF9   | PF8   | PF7   | PF6   | PF5   | PF4   | PF3   | PF2   | PF1   | PF0   |

### 4.4 Opamp Pinout Overview

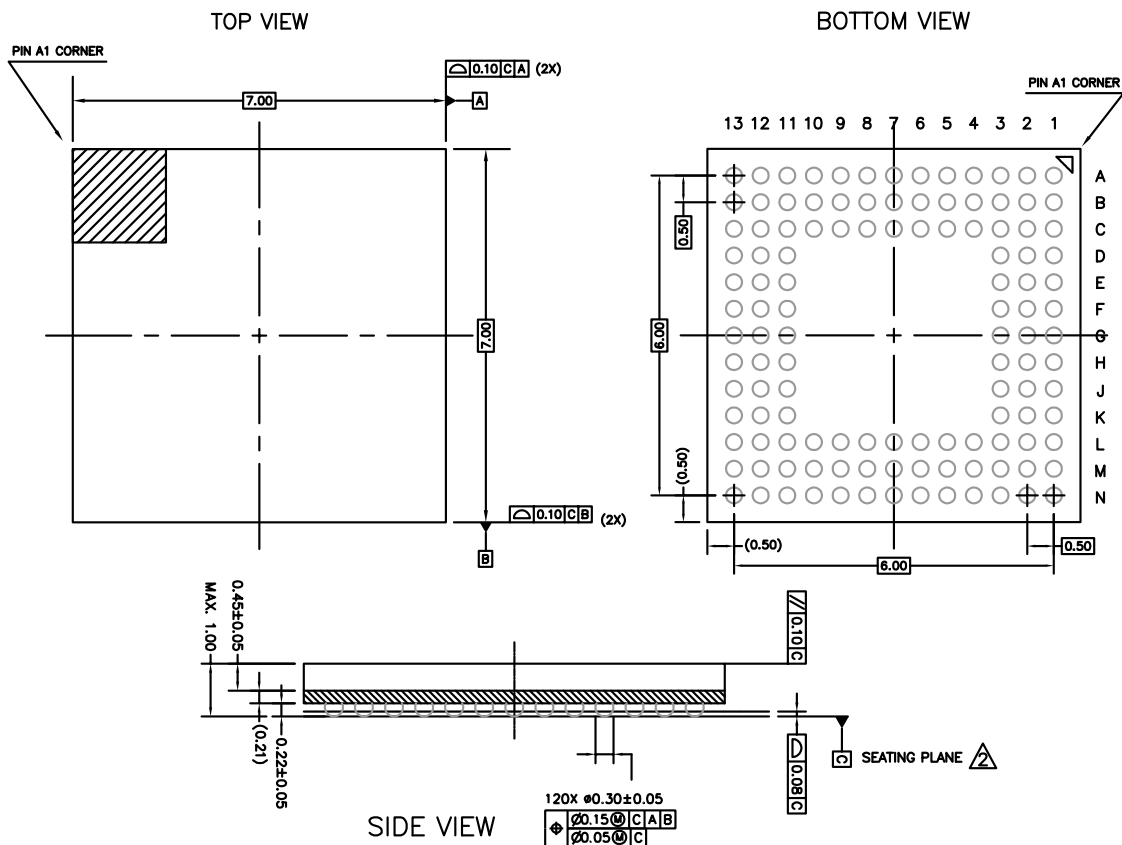
The specific opamp terminals available in EFM32WG995 is shown in Figure 4.2 (p. 67) .

Figure 4.2. Opamp Pinout



### 4.5 BGA120 Package

Figure 4.3. BGA120



Rev: 97SPPO1321A\_XO1\_06APR2011

Note:

1. The dimensions in parenthesis are reference.
2. Datum "C" and seating plane are defined by the crown of the solder balls.
3. All dimensions are in millimeters.

The BGA120 Package uses SAC105 solderballs.

All EFM32 packages are RoHS compliant and free of Bromine (Br) and Antimony (Sb).

For additional Quality and Environmental information, please see:  
<http://www.silabs.com/support/quality/pages/default.aspx>.

# 5 PCB Layout and Soldering

## 5.1 Recommended PCB Layout

Figure 5.1. BGA120 PCB Land Pattern

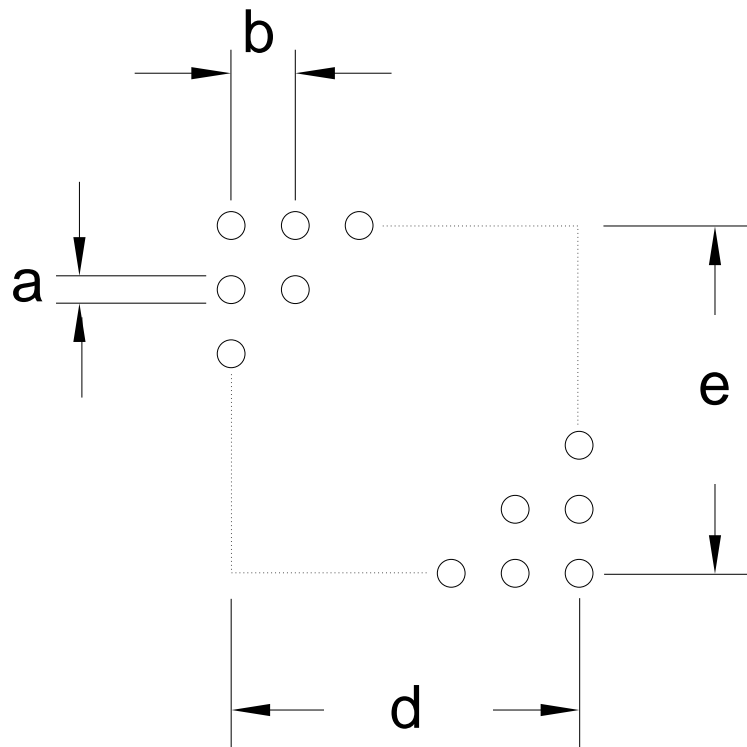
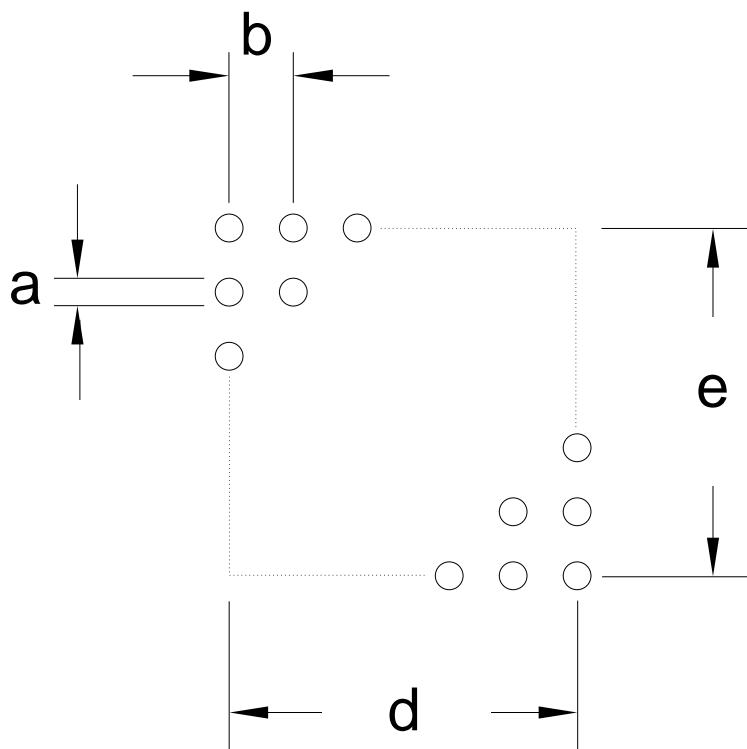


Table 5.1. BGA120 PCB Land Pattern Dimensions (Dimensions in mm)

| Symbol | Dim. (mm) |
|--------|-----------|
| a      | 0.25      |
| b      | 0.50      |
| d      | 6.00      |
| e      | 6.00      |

**Figure 5.2. BGA120 PCB Solder Mask**



**Table 5.2. BGA120 PCB Solder Mask Dimensions (Dimensions in mm)**

| Symbol | Dim. (mm) |
|--------|-----------|
| a      | 0.35      |
| b      | 0.50      |
| d      | 6.00      |
| e      | 6.00      |

Figure 5.3. BGA120 PCB Stencil Design

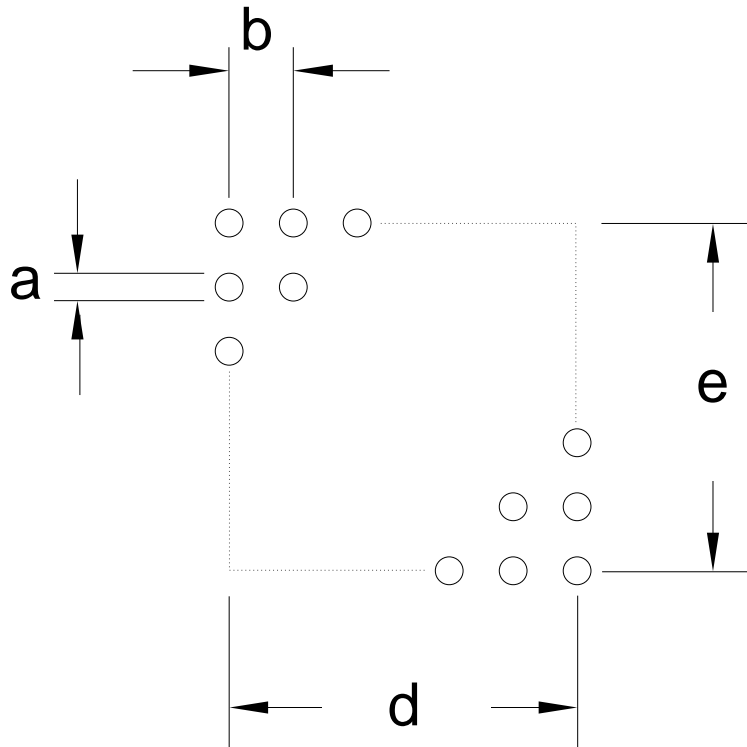


Table 5.3. BGA120 PCB Stencil Design Dimensions (Dimensions in mm)

| Symbol | Dim. (mm) |
|--------|-----------|
| a      | 0.25      |
| b      | 0.50      |
| d      | 6.00      |
| e      | 6.00      |

1. The drawings are not to scale.
2. All dimensions are in millimeters.
3. All drawings are subject to change without notice.
4. The PCB Land Pattern drawing is in compliance with IPC-7351B.
5. Stencil thickness 0.125 mm.
6. For detailed pin-positioning, see Figure 4.3 (p. 67) .

## 5.2 Soldering Information

The latest IPC/JEDEC J-STD-020 recommendations for Pb-Free reflow soldering should be followed.

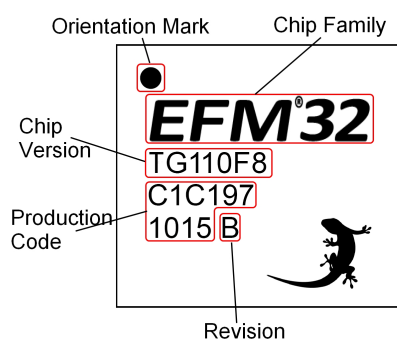
The packages have a Moisture Sensitivity Level rating of 3, please see the latest IPC/JEDEC J-STD-033 standard for MSL description and level 3 bake conditions.

## 6 Chip Marking, Revision and Errata

### 6.1 Chip Marking

In the illustration below package fields and position are shown.

**Figure 6.1. Example Chip Marking**



### 6.2 Revision

The revision of a chip can be determined from the "Revision" field in Figure 6.1 (p. 72) .

### 6.3 Errata

Please see the errata document for EFM32WG995 for description and resolution of device erratas. This document is available in Simplicity Studio and online at:

<http://www.silabs.com/support/pages/document-library.aspx?p=MCUs--32-bit>



## 7 Revision History

### 7.1 Revision 1.31

November 21st, 2013

Updated figures.

Updated errata-link.

Updated chip marking.

Added link to Environmental and Quality information.

Re-added missing DAC-data.

### 7.2 Revision 1.30

September 30th, 2013

Added I2C characterization data.

Added SPI characterization data.

Corrected the DAC and OPAMP2 pin sharing information in the Alternate Functionality Pinout section.

Added the USB bootloader information.

Corrected the ADC resolution from 12, 10 and 6 bit to 12, 8 and 6 bit.

Updated the EM0 and EM1 current consumption numbers. Updated the the EM1 plots and removed the EM0 plots.

Updated Environmental information.

Updated trademark, disclaimer and contact information.

Other minor corrections.

### 7.3 Revision 1.20

June 28th, 2013

Corrected pinout top view figure.

Updated PCB Land Pattern, PCB Solder Mask and PCB Stencil Design figures.

Updated power requirements in the Power Management section.

Removed minimum load capacitance figure and table. Added reference to application note.

Other minor corrections.

### 7.4 Revision 1.10

May 6th, 2013

Updated current consumption table and figures in Electrical characteristics section.

Other minor corrections.

## 7.5 Revision 1.00

September 11th, 2012

Updated the HFRCO 1 MHz band typical value to 1.2 MHz.

Updated the HFRCO 7 MHz band typical value to 6.6 MHz.

Corrected BGA solder balls material from Sn96.5/Ag3/Cu0.5 to SAC105.

Other minor corrections.

## 7.6 Revision 0.95

May 3rd, 2012

Updated EM2/EM3 current consumption at 85°C.

## 7.7 Revision 0.90

February 27th, 2012

Initial preliminary release.

# A Disclaimer and Trademarks

## A.1 Disclaimer

*Silicon Laboratories intends to provide customers with the latest, accurate, and in-depth documentation of all peripherals and modules available for system and software implementers using or intending to use the Silicon Laboratories products. Characterization data, available modules and peripherals, memory sizes and memory addresses refer to each specific device, and "Typical" parameters provided can and do vary in different applications. Application examples described herein are for illustrative purposes only. Silicon Laboratories reserves the right to make changes without further notice and limitation to product information, specifications, and descriptions herein, and does not give warranties as to the accuracy or completeness of the included information. Silicon Laboratories shall have no liability for the consequences of use of the information supplied herein. This document does not imply or express copyright licenses granted hereunder to design or fabricate any integrated circuits. The products must not be used within any Life Support System without the specific written consent of Silicon Laboratories. A "Life Support System" is any product or system intended to support or sustain life and/or health, which, if it fails, can be reasonably expected to result in significant personal injury or death. Silicon Laboratories products are generally not intended for military applications. Silicon Laboratories products shall under no circumstances be used in weapons of mass destruction including (but not limited to) nuclear, biological or chemical weapons, or missiles capable of delivering such weapons.*

## A.2 Trademark Information

Silicon Laboratories Inc., Silicon Laboratories, Silicon Labs, SiLabs and the Silicon Labs logo, CMEMS<sup>®</sup>, EFM, EFM32, EFR, Energy Micro, Energy Micro logo and combinations thereof, "the world's most energy friendly microcontrollers", Ember<sup>®</sup>, EZLink<sup>®</sup>, EZMac<sup>®</sup>, EZRadio<sup>®</sup>, EZRadioPRO<sup>®</sup>, DSPLL<sup>®</sup>, ISO-modem<sup>®</sup>, Precision32<sup>®</sup>, ProSLIC<sup>®</sup>, SiPHY<sup>®</sup>, USBXpress<sup>®</sup> and others are trademarks or registered trademarks of Silicon Laboratories Inc. ARM, CORTEX, Cortex-M3 and THUMB are trademarks or registered trademarks of ARM Holdings. Keil is a registered trademark of ARM Limited. All other products or brand names mentioned herein are trademarks of their respective holders.

## B Contact Information

**Silicon Laboratories Inc.**

400 West Cesar Chavez

Austin, TX 78701

Please visit the Silicon Labs Technical Support web page:

<http://www.silabs.com/support/pages/contacttechnicalsupport.aspx>

and register to submit a technical support request.

## Table of Contents

|  |    |
|--|----|
| 1. Ordering Information .....              | 2  |
| 2. System Summary .....                    | 3  |
| 2.1. System Introduction .....             | 3  |
| 2.2. Configuration Summary .....           | 7  |
| 2.3. Memory Map .....                      | 9  |
| 3. Electrical Characteristics .....        | 10 |
| 3.1. Test Conditions .....                 | 10 |
| 3.2. Absolute Maximum Ratings .....        | 10 |
| 3.3. General Operating Conditions .....    | 10 |
| 3.4. Current Consumption .....             | 11 |
| 3.5. Transition between Energy Modes ..... | 17 |
| 3.6. Power Management .....                | 18 |
| 3.7. Flash .....                           | 19 |
| 3.8. General Purpose Input Output .....    | 20 |
| 3.9. Oscillators .....                     | 27 |
| 3.10. Analog Digital Converter (ADC) ..... | 31 |
| 3.11. Digital Analog Converter (DAC) ..... | 41 |
| 3.12. Operational Amplifier (OPAMP) .....  | 42 |
| 3.13. Analog Comparator (ACMP) .....       | 46 |
| 3.14. Voltage Comparator (VCMP) .....      | 48 |
| 3.15. LCD .....                            | 49 |
| 3.16. I2C .....                            | 50 |
| 3.17. USART SPI .....                      | 51 |
| 3.18. Digital Peripherals .....            | 53 |
| 4. Pinout and Package .....                | 54 |
| 4.1. Pinout .....                          | 54 |
| 4.2. Alternate Functionality Pinout .....  | 58 |
| 4.3. GPIO Pinout Overview .....            | 66 |
| 4.4. Opamp Pinout Overview .....           | 67 |
| 4.5. BGA120 Package .....                  | 67 |
| 5. PCB Layout and Soldering .....          | 69 |
| 5.1. Recommended PCB Layout .....          | 69 |
| 5.2. Soldering Information .....           | 71 |
| 6. Chip Marking, Revision and Errata ..... | 72 |
| 6.1. Chip Marking .....                    | 72 |
| 6.2. Revision .....                        | 72 |
| 6.3. Errata .....                          | 72 |
| 7. Revision History .....                  | 73 |
| 7.1. Revision 1.31 .....                   | 73 |
| 7.2. Revision 1.30 .....                   | 73 |
| 7.3. Revision 1.20 .....                   | 73 |
| 7.4. Revision 1.10 .....                   | 73 |
| 7.5. Revision 1.00 .....                   | 74 |
| 7.6. Revision 0.95 .....                   | 74 |
| 7.7. Revision 0.90 .....                   | 74 |
| A. Disclaimer and Trademarks .....         | 75 |
| A.1. Disclaimer .....                      | 75 |
| A.2. Trademark Information .....           | 75 |
| B. Contact Information .....               | 76 |
| B.1. ....                                  | 76 |

## List of Figures

|  |    |
|--|----|
| 2.1. Block Diagram .....   | 3  |
| 2.2. EFM32WG995 Memory Map with largest RAM and Flash sizes .....                                  | 9  |
| 3.1. EM1 Current consumption with all peripheral clocks disabled and HFXO running at 48MHz .....   | 13 |
| 3.2. EM1 Current consumption with all peripheral clocks disabled and HFRCO running at 28MHz .....  | 13 |
| 3.3. EM1 Current consumption with all peripheral clocks disabled and HFRCO running at 21MHz .....  | 14 |
| 3.4. EM1 Current consumption with all peripheral clocks disabled and HFRCO running at 14MHz .....  | 14 |
| 3.5. EM1 Current consumption with all peripheral clocks disabled and HFRCO running at 11MHz .....  | 15 |
| 3.6. EM1 Current consumption with all peripheral clocks disabled and HFRCO running at 6.6MHz ..... | 15 |
| 3.7. EM1 Current consumption with all peripheral clocks disabled and HFRCO running at 1.2MHz ..... | 16 |
| 3.8. EM2 current consumption. RTC prescaled to 1kHz, 32.768 kHz LFRCO. ....                        | 16 |
| 3.9. EM3 current consumption. ....   | 17 |
| 3.10. EM4 current consumption. ....  | 17 |
| 3.11. Typical Low-Level Output Current, 2V Supply Voltage .....                                    | 21 |
| 3.12. Typical High-Level Output Current, 2V Supply Voltage .....                                   | 22 |
| 3.13. Typical Low-Level Output Current, 3V Supply Voltage .....                                    | 23 |
| 3.14. Typical High-Level Output Current, 3V Supply Voltage .....                                   | 24 |
| 3.15. Typical Low-Level Output Current, 3.8V Supply Voltage .....                                  | 25 |
| 3.16. Typical High-Level Output Current, 3.8V Supply Voltage .....                                 | 26 |
| 3.17. Calibrated LFRCO Frequency vs Temperature and Supply Voltage .....                           | 29 |
| 3.18. Calibrated HFRCO 11 MHz Band Frequency vs Supply Voltage and Temperature .....               | 30 |
| 3.19. Calibrated HFRCO 14 MHz Band Frequency vs Supply Voltage and Temperature .....               | 30 |
| 3.20. Calibrated HFRCO 21 MHz Band Frequency vs Supply Voltage and Temperature .....               | 30 |
| 3.21. Calibrated HFRCO 28 MHz Band Frequency vs Supply Voltage and Temperature .....               | 31 |
| 3.22. Integral Non-Linearity (INL) .....   | 36 |
| 3.23. Differential Non-Linearity (DNL) .....   | 36 |
| 3.24. ADC Frequency Spectrum, V <sub>dd</sub> = 3V, Temp = 25°C .....                              | 37 |
| 3.25. ADC Integral Linearity Error vs Code, V <sub>dd</sub> = 3V, Temp = 25°C .....                | 38 |
| 3.26. ADC Differential Linearity Error vs Code, V <sub>dd</sub> = 3V, Temp = 25°C .....            | 39 |
| 3.27. ADC Absolute Offset, Common Mode = V <sub>dd</sub> /2 .....                                  | 40 |
| 3.28. ADC Dynamic Performance vs Temperature for all ADC References, V <sub>dd</sub> = 3V .....    | 40 |
| 3.29. ADC Temperature sensor readout .....   | 41 |
| 3.30. OPAMP Common Mode Rejection Ratio .....  | 44 |
| 3.31. OPAMP Positive Power Supply Rejection Ratio .....  | 44 |
| 3.32. OPAMP Negative Power Supply Rejection Ratio .....  | 45 |
| 3.33. OPAMP Voltage Noise Spectral Density (Unity Gain) V <sub>out</sub> =1V .....                 | 45 |
| 3.34. OPAMP Voltage Noise Spectral Density (Non-Unity Gain) .....                                  | 45 |
| 3.35. ACMP Characteristics, V <sub>dd</sub> = 3V, Temp = 25°C, FULLBIAS = 0, HALFBIAS = 1 .....    | 47 |
| 3.36. SPI Master Timing .....  | 51 |
| 3.37. SPI Slave Timing .....   | 52 |
| 4.1. EFM32WG995 Pinout (top view, not to scale) .....  | 54 |
| 4.2. Opamp Pinout .....  | 67 |
| 4.3. BGA120 .....  | 67 |
| 5.1. BGA120 PCB Land Pattern .....   | 69 |
| 5.2. BGA120 PCB Solder Mask .....  | 70 |
| 5.3. BGA120 PCB Stencil Design .....   | 71 |
| 6.1. Example Chip Marking .....  | 72 |

## List of Tables

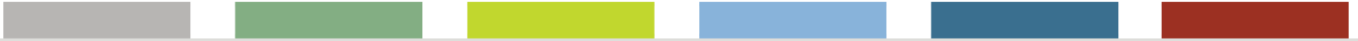
|  |    |
|--|----|
| 1.1. Ordering Information .....                                    | 2  |
| 2.1. Configuration Summary .....                                   | 8  |
| 3.1. Absolute Maximum Ratings .....                                | 10 |
| 3.2. General Operating Conditions .....                            | 10 |
| 3.3. Environmental .....   | 11 |
| 3.4. Current Consumption .....                                     | 11 |
| 3.5. Energy Modes Transitions .....                                | 17 |
| 3.6. Power Management .....  | 18 |
| 3.7. Flash .....   | 19 |
| 3.8. GPIO .....  | 20 |
| 3.9. LFXO .....  | 27 |
| 3.10. HFXO .....   | 28 |
| 3.11. LFRCO .....  | 28 |
| 3.12. HFRCO .....  | 29 |
| 3.13. ULFRCO .....   | 31 |
| 3.14. ADC .....  | 31 |
| 3.15. DAC .....  | 41 |
| 3.16. OPAMP .....  | 42 |
| 3.17. ACMP .....   | 46 |
| 3.18. VCMP .....   | 48 |
| 3.19. LCD .....  | 49 |
| 3.20. I2C Standard-mode (Sm) .....                                 | 50 |
| 3.21. I2C Fast-mode (Fm) .....                                     | 50 |
| 3.22. I2C Fast-mode Plus (Fm+) .....                               | 51 |
| 3.23. SPI Master Timing .....                                      | 51 |
| 3.24. SPI Master Timing with SSSEARLY and SMSDELAY .....           | 52 |
| 3.25. SPI Slave Timing .....                                       | 52 |
| 3.26. SPI Slave Timing with SSSEARLY and SMSDELAY .....            | 52 |
| 3.27. Digital Peripherals .....                                    | 53 |
| 4.1. Device Pinout .....   | 54 |
| 4.2. Alternate functionality overview .....                        | 59 |
| 4.3. GPIO Pinout .....   | 66 |
| 5.1. BGA120 PCB Land Pattern Dimensions (Dimensions in mm) .....   | 69 |
| 5.2. BGA120 PCB Solder Mask Dimensions (Dimensions in mm) .....    | 70 |
| 5.3. BGA120 PCB Stencil Design Dimensions (Dimensions in mm) ..... | 71 |

## List of Equations

|   |    |
|---|----|
| 3.1. Total ACMP Active Current .....                                      | 46 |
| 3.2. VCMP Trigger Level as a Function of Level Setting .....              | 48 |
| 3.3. Total LCD Current Based on Operational Mode and Internal Boost ..... | 49 |



# silabs.com



**ZERO**  
ARM Cortex-M0+



**TINY**  
ARM Cortex-M3



**GECKO**  
ARM Cortex-M3



**LEOPARD**  
ARM Cortex-M3



**GIANT**  
ARM Cortex-M3



**WONDER**  
ARM Cortex-M4

