

## Data Sheet | Item Number: 2002-1201

2-conductor through terminal block; 2.5 mm<sup>2</sup>; suitable for Ex e II applications; side and center marking; for DIN-rail 35 x 15 and 35 x 7.5; Push-in CAGE CLAMP®; 2,50 mm<sup>2</sup>; gray

<https://www.wago.com/2002-1201>

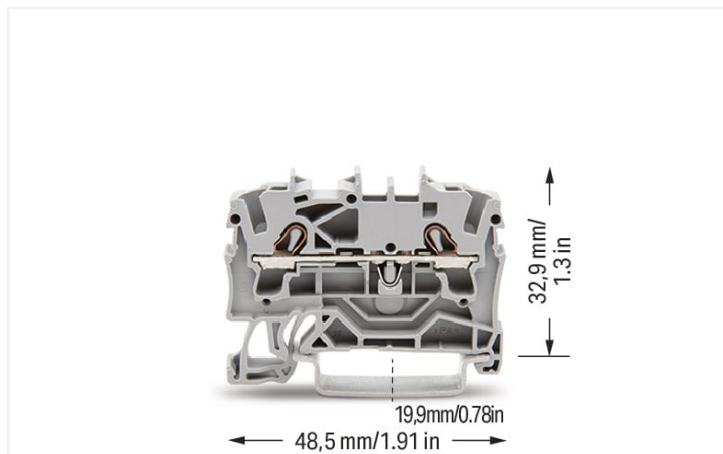

Color: ■ gray

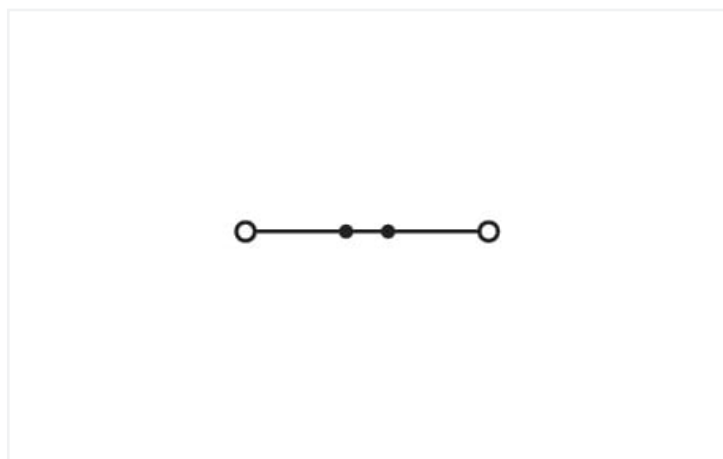

Similar to illustration

### Electrical data

Ratings per	IEC/EN 60947-7-1		
Overvoltage category	III	III	II
Pollution degree	3	2	2
Nominal voltage	800 V	-	-
Rated surge voltage	8 kV	-	-
Rated current	24 A	-	-
Current at conductor cross-section (max.) mm <sup>2</sup>	32 A	-	-

Approvals per	UL 1059		
Use group	B	C	D
Rated voltage	600 V	600 V	-
Rated current	20 A	20 A	-

Approvals per	CSA 22.2 No 158		
Use group	B	C	D
Rated voltage	600 V	600 V	-
Rated current	20 A	20 A	-

Ex information	
Reference hazardous areas	See application instructions in section "Knowledge and Downloads – Documentation – Additional Information: Technical Section; Technical Explanations"
Ratings per	ATEX: PTB 03 ATEX 1162 U / IECEx: PTB 03.0004U (Ex eb IIC Gb)
Rated voltage EN (Ex e II)	550 V
Rated current (Ex e II)	22 A
Rated current (Ex e II) with jumper	20 A

### Power Loss

Power loss, per pole (potential)	0.7661 W
Rated current $I_N$ for specified power loss	24 A
Resistance value for specified, current-dependent power loss	0.00133 $\Omega$

### Connection data

Connection points	2
Total number of potentials	1
Number of levels	1
Number of jumper slots	2

### Connection 1

Connection technology	Push-in CAGE CLAMP®
Actuation type	Operating tool
Connectable conductor materials	Copper
Nominal cross-section	2.5 mm <sup>2</sup>
Solid conductor	0.25 ... 4 mm <sup>2</sup> / 22 ... 12 AWG
Solid conductor; push-in termination	1 ... 4 mm <sup>2</sup> / 18 ... 12 AWG
Fine-stranded conductor	0.25 ... 4 mm <sup>2</sup> / 22 ... 12 AWG
Fine-stranded conductor; with insulated ferrule	0.25 ... 2.5 mm <sup>2</sup> / 22 ... 14 AWG
Fine-stranded conductor; with ferrule; push-in termination	1 ... 2.5 mm <sup>2</sup> / 18 ... 14 AWG
Note (conductor cross-section)	Depending on the conductor characteristic, a conductor with a smaller cross-section can also be inserted via push-in termination.
Strip length	10 ... 12 mm / 0.39 ... 0.47 inches
Wiring direction	Front-entry wiring

### Physical data

Width	5.2 mm / 0.205 inches
Height	48.5 mm / 1.909 inches
Depth from upper-edge of DIN-rail	32.9 mm / 1.295 inches

### Mechanical data

Mounting type	DIN-35 rail
Marking level	Center/side marking

### Material data

Note (material data)	<a href="#">Information on material specifications can be found here</a>
Color	gray
Material group	I
Insulation material	Polyamide (PA66)
Flammability class per UL94	V0
Fire load	0.128 MJ
Weight	5.1 g

### Environmental requirements

Processing temperature	-35 ... +85 °C
Continuous operating temperature	-60 ... +105 °C

### Commercial data

Product Group	22 (TOPJOB S)
eCl@ss 10.0	27-14-11-20
eCl@ss 9.0	27-14-11-20
ETIM 8.0	EC000897
ETIM 7.0	EC000897
PU (SPU)	100 pcs
Packaging type	Box
GTIN	4017332999168

### Environmental Product Compliance

RoHS Compliance Status	Compliant, No Exemption
------------------------	-------------------------

### Approvals / Certificates

#### General approvals



Approval	Standard	Certificate Name
CCA DEKRA Certification B.V.	EN 60947	NTR NL 7941
CSA DEKRA Certification B.V.	C22.2 No. 158	1536069
KEMA/KEUR DEKRA Certification B.V.	EN 60947	71-124163
UL Underwriters Laboratories Inc.	UL 1059	E45172

#### Declarations of conformity and manufacturer's declarations



Approval	Standard	Certificate Name
ATEX-Attestation of Conformity WAGO GmbH & Co. KG	-	-
EU-Declaration of Conformity WAGO GmbH & Co. KG	-	-
Railway WAGO GmbH & Co. KG	-	Railway Ready
UK-Declaration of Conformity WAGO GmbH & Co. KG	-	-

#### Approvals for marine applications



Approval	Standard	Certificate Name
ABS American Bureau of Shipping	EN 60947	20-HG1941090-PDA
BV Bureau Veritas S.A.	EN 60947	38586/B0 BV
DNV GL Det Norske Veritas, Germanischer Lloyd	-	TAE00001V2

#### Approvals for hazardous areas



Approval	Standard	Certificate Name
AEx Underwriters Laboratories Inc.	UL 60079	E185892 (AEx eb IIC resp. Ex eb IIC)
ATEX Physikalisch Technische Bundesanstalt	EN 60079	PTB 03 ATEX 1162 U (II2G Ex eb IIC Gb, IM2 Ex eb IMb)
CCC CNEX	GB/T 3836.3	2020312313000238 (Ex eb IIC Gb, Ex eb I Mb)
EAC Brjansker Zertifizierungsstelle	TP TC 012/2011	RU C-DE.AM02. B.00127/19 (Ex e IIC Gb U)
IECEX Physikalisch Technische Bundesanstalt	IEC 60079	IECEX PTB 03.0004U (Ex eb IIC Gb or Ex eb I Mb)
INMETRO TUV Rheinland do Brasil Ltda.	IEC 60079	TUV 12.1307 U

**Approvals for hazardous areas**

KTL Korea Testing Laboratory	EN IEC 60079-0, EN IEC 60079-7	19-KA4B0-0921U
---------------------------------	-----------------------------------	----------------

**Downloads**

**Environmental Product Compliance**

Compliance Search	
Environmental Product Compliance 2002-1201	<a href="#">↓</a>

**Documentation**

Additional Information		
Technical Section	pdf 2240.62 KB	<a href="#">↓</a>

Bid Text			
2002-1201	29.04.2019	xml 4.15 KB	<a href="#">↓</a>
2002-1201	23.04.2019	docx 14.68 KB	<a href="#">↓</a>

**CAD/CAE-Data**

CAD data	
2D/3D Models 2002-1201	<a href="#">↓</a>

CAE data	
EPLAN Data Portal 2002-1201	<a href="#">↓</a>
WSCAD Universe 2002-1201	<a href="#">↓</a>
ZUKEN Portal 2002-1201	<a href="#">↓</a>

**1 Compatible Products**

**1.1 Required Accessories**

**1.1.1 End plate**

**1.1.1.1 End plate**



**Item No.: 2002-1291**  
End and intermediate plate; 0.8 mm thick; gray



**Item No.: 2002-1292**  
End and intermediate plate; 0.8 mm thick; orange



**Item No.: 209-191**  
Separator for Ex e/Ex i applications; 3 mm thick; 120 mm wide; orange



**Item No.: 209-190**  
Separator for Ex e/Ex i applications; 3 mm thick; 90 mm wide; orange



**Item No.: 2002-1293**  
Separator plate; 2 mm thick; oversized; gray



**Item No.: 2002-1294**  
Separator plate; 2 mm thick; oversized; orange

## 1.2 Optional Accessories

### 1.2.1 DIN-rail

#### 1.2.1.1 Mounting accessories



**Item No.: 210-196**

Aluminum carrier rail; 35 x 8.2 mm; 1.6 mm thick; 2 m long; unslotted; similar to EN 60715; silver-colored



**Item No.: 210-198**

Copper carrier rail; 35 x 15 mm; 2.3 mm thick; 2 m long; unslotted; according to EN 60715; copper-colored



**Item No.: 210-508**

Steel carrier rail; 35 x 15 mm; 1.5 mm thick; 2 m long; slotted; galvanized; similar to EN 60715; silver-colored



**Item No.: 210-197**

Steel carrier rail; 35 x 15 mm; 1.5 mm thick; 2 m long; slotted; similar to EN 60715; silver-colored



**Item No.: 210-506**

Steel carrier rail; 35 x 15 mm; 1.5 mm thick; 2 m long; unslotted; galvanized; similar to EN 60715; silver-colored



**Item No.: 210-114**

Steel carrier rail; 35 x 15 mm; 1.5 mm thick; 2 m long; unslotted; similar to EN 60715; silver-colored



**Item No.: 210-118**

Steel carrier rail; 35 x 15 mm; 2.3 mm thick; 2 m long; unslotted; according to EN 60715; silver-colored



**Item No.: 210-115**

Steel carrier rail; 35 x 7.5 mm; 1 mm thick; 2 m long; slotted; according to EN 60715; "Hole width 18 mm; silver-colored



**Item No.: 210-112**

Steel carrier rail; 35 x 7.5 mm; 1 mm thick; 2 m long; slotted; according to EN 60715; "Hole width 25 mm; silver-colored



**Item No.: 210-504**

Steel carrier rail; 35 x 7.5 mm; 1 mm thick; 2 m long; slotted; galvanized; according to EN 60715; silver-colored



**Item No.: 210-113**

Steel carrier rail; 35 x 7.5 mm; 1 mm thick; 2 m long; unslotted; according to EN 60715; silver-colored



**Item No.: 210-505**

Steel carrier rail; 35 x 7.5 mm; 1 mm thick; 2 m long; unslotted; galvanized; according to EN 60715; silver-colored

### 1.2.2 Ferrule

#### 1.2.2.1 Ferrule



**Item No.: 216-241**

Ferrule; Sleeve for 0.5 mm<sup>2</sup> / 20 AWG; insulated; electro-tin plated; electrolytic copper; gastight crimped; acc. to DIN 46228, Part 4/09.90; white



**Item No.: 216-242**

Ferrule; Sleeve for 0.75 mm<sup>2</sup> / 18 AWG; insulated; electro-tin plated; electrolytic copper; gastight crimped; acc. to DIN 46228, Part 4/09.90; gray



**Item No.: 216-262**

Ferrule; Sleeve for 0.75 mm<sup>2</sup> / 18 AWG; insulated; electro-tin plated; electrolytic copper; gastight crimped; acc. to DIN 46228, Part 4/09.90; gray



**Item No.: 216-243**

Ferrule; Sleeve for 1 mm<sup>2</sup> / AWG 18; insulated; electro-tin plated; electrolytic copper; gastight crimped; acc. to DIN 46228, Part 4/09.90; red



**Item No.: 216-263**

Ferrule; Sleeve for 1 mm<sup>2</sup> / AWG 18; insulated; electro-tin plated; electrolytic copper; gastight crimped; acc. to DIN 46228, Part 4/09.90; red



**Item No.: 216-244**

Ferrule; Sleeve for 1.5 mm<sup>2</sup> / AWG 16; insulated; electro-tin plated; electrolytic copper; gastight crimped; acc. to DIN 46228, Part 4/09.90; black



**Item No.: 216-264**

Ferrule; Sleeve for 1.5 mm<sup>2</sup> / AWG 16; insulated; electro-tin plated; electrolytic copper; gastight crimped; acc. to DIN 46228, Part 4/09.90; black



**Item No.: 216-246**

Ferrule; Sleeve for 2.5 mm<sup>2</sup> / AWG 14; insulated; electro-tin plated; electrolytic copper; gastight crimped; acc. to DIN 46228, Part 4/09.90; blue



**Item No.: 216-266**

Ferrule; Sleeve for 2.5 mm<sup>2</sup> / AWG 14; insulated; electro-tin plated; electrolytic copper; gastight crimped; acc. to DIN 46228, Part 4/09.90; blue

### 1.2.3 Installation

#### 1.2.3.1 Cover



**Item No.: 709-156**

Cover; Type 3; suitable for cover carrier, type 3; 1 m long; transparent

1.2.3.2 Cover carrier



**Item No.: 709-169**

Cover carrier; Type 3; incl. fixing/retaining screws and knurled nut; suitable for 279 to 282 and 880 Series rail-mounted terminal blocks; suitable for 264 Series miniature rail-mounted terminal blocks; suitable for 270 Series sensor and actuator terminal blocks; gray

1.2.4 Insulation stop

1.2.4.1 Insulation stop



**Item No.: 2002-171**

Insulation stop; 0.25 - 0.5 mm<sup>2</sup>; 5 pieces/strip; light gray



**Item No.: 2002-172**

Insulation stop; 0.75 - 1 mm<sup>2</sup>; 5 pieces/strip; dark gray

1.2.5 Jumper

1.2.5.1 Jumper



**Item No.: 2002-400**

Continuous jumper; 2-way; insulated; light gray



**Item No.: 2002-423/000-006**

Continuous jumper; from 1 to 3; insulated; blue



**Item No.: 2002-423**

Continuous jumper; from 1 to 3; insulated; light gray



**Item No.: 2002-423/000-005**

Continuous jumper; from 1 to 3; insulated; red



**Item No.: 2002-424/000-006**

Continuous jumper; from 1 to 4; insulated; blue



**Item No.: 2002-424**

Continuous jumper; from 1 to 4; insulated; light gray



**Item No.: 2002-424/000-005**

Continuous jumper; from 1 to 4; insulated; red



**Item No.: 2002-406/020-000**

Delta jumper; insulated; light gray



**Item No.: 2002-410/000-006**

Jumper; 10-way; insulated; blue



**Item No.: 2002-410**

Jumper; 10-way; insulated; light gray



**Item No.: 2002-410/000-005**

Jumper; 10-way; insulated; red



**Item No.: 2002-402/000-006**

Jumper; 2-way; insulated; blue



**Item No.: 2002-402**

Jumper; 2-way; insulated; light gray



**Item No.: 2002-402/000-005**

Jumper; 2-way; insulated; red



**Item No.: 2002-403/000-006**

Jumper; 3-way; insulated; blue



**Item No.: 2002-403**

Jumper; 3-way; insulated; light gray



**Item No.: 2002-403/000-005**

Jumper; 3-way; insulated; red



**Item No.: 2002-404/000-006**

Jumper; 4-way; insulated; blue



**Item No.: 2002-404**

Jumper; 4-way; insulated; light gray



**Item No.: 2002-404/000-005**

Jumper; 4-way; insulated; red



**Item No.: 2002-405/000-006**

Jumper; 5-way; insulated; blue



**Item No.: 2002-405**

Jumper; 5-way; insulated; light gray



**Item No.: 2002-405/000-005**

Jumper; 5-way; insulated; red



**Item No.: 2002-406/000-006**

Jumper; 6-way; insulated; blue



**Item No.: 2002-406**

Jumper; 6-way; insulated; light gray



**Item No.: 2002-406/000-005**

Jumper; 6-way; insulated; red



**Item No.: 2002-407/000-006**

Jumper; 7-way; insulated; blue



**Item No.: 2002-407**

Jumper; 7-way; insulated; light gray



**Item No.: 2002-407/000-005**

Jumper; 7-way; insulated; red



**Item No.: 2002-408/000-006**

Jumper; 8-way; insulated; blue



**Item No.: 2002-408**

Jumper; 8-way; insulated; light gray



**Item No.: 2002-408/000-005**

Jumper; 8-way; insulated; red



**Item No.: 2002-409/000-006**

Jumper; 9-way; insulated; blue



**Item No.: 2002-409**

Jumper; 9-way; insulated; light gray



**Item No.: 2002-409/000-005**

Jumper; 9-way; insulated; red



**Item No.: 2002-440**



Jumper; from 1 to 10; insulated; light gray

1.2.5.1 Jumper













 <b>Item No.: 2002-433</b> Jumper; from 1 to 3; insulated; light gray	 <b>Item No.: 2002-434</b> Jumper; from 1 to 4; insulated; light gray	 <b>Item No.: 2002-435</b> Jumper; from 1 to 5; insulated; light gray	 <b>Item No.: 2002-436</b> Jumper; from 1 to 6; insulated; light gray
 <b>Item No.: 2002-437</b> Jumper; from 1 to 7; insulated; light gray	 <b>Item No.: 2002-438</b> Jumper; from 1 to 8; insulated; light gray	 <b>Item No.: 2002-439</b> Jumper; from 1 to 9; insulated; light gray	 <b>Item No.: 2002-480</b> Staggered jumper; 10-way; insulated; light gray
 <b>Item No.: 2002-481</b> Staggered jumper; 11-way; insulated; light gray	 <b>Item No.: 2002-482</b> Staggered jumper; 12-way; insulated; light gray	 <b>Item No.: 2002-473/011-000</b> Staggered jumper; 2-way; from 1 to 3; insulated; light gray	 <b>Item No.: 2002-472</b> Staggered jumper; 2-way; insulated; light gray
 <b>Item No.: 2002-473</b> Staggered jumper; 3-way; insulated; light gray	 <b>Item No.: 2002-475/011-000</b> Staggered jumper; 3-way; insulated; light gray	 <b>Item No.: 2002-474</b> Staggered jumper; 4-way; insulated; light gray	 <b>Item No.: 2002-475</b> Staggered jumper; 5-way; insulated; light gray
 <b>Item No.: 2002-476</b> Staggered jumper; 6-way; insulated; light gray	 <b>Item No.: 2002-477</b> Staggered jumper; 7-way; insulated; light gray	 <b>Item No.: 2002-478</b> Staggered jumper; 8-way; insulated; light gray	 <b>Item No.: 2002-479</b> Staggered jumper; 9-way; insulated; light gray
 <b>Item No.: 2002-477/011-000</b> Staggered jumper; insulated; light gray	 <b>Item No.: 2002-479/011-000</b> Staggered jumper; insulated; light gray	 <b>Item No.: 2002-481/011-000</b> Staggered jumper; insulated; light gray	 <b>Item No.: 2002-405/011-000</b> Star point jumper; 3-way; insulated; light gray
 <b>Item No.: 2006-499</b> Step-down jumper; from 2006/2004 to 2004/2002/2001 series; from 2206/2204 to 2204/2202/2201 series; insulated; light gray	 <b>Item No.: 2016-499</b> Step-down jumper; from 2016/2010 to 2010/2006/2004/2002 series; from 2216/2210 to 2210/2206/2204/2202 series; insulated; light gray	 <b>Item No.: 210-103</b> Wire commoning chain; insulated; black	 <b>Item No.: 210-123</b> Wire commoning chain; insulated; blue

1.2.6 Marking

1.2.6.1 Group marker carrier

 <b>Item No.: 2009-191</b> Group marker carrier; gray	 <b>Item No.: 2009-192</b> Group marker carrier; gray	 <b>Item No.: 2009-193</b> Group marker carrier; gray
--	--	--

1.2.6.2 Marker

 <b>Item No.: 2009-145/000-006</b> Mini-WSB Inline; for Smart Printer; 1700 pieces on roll; stretchable 5 - 5.2 mm; plain; snap-on type; blue	 <b>Item No.: 2009-145/000-007</b> Mini-WSB Inline; for Smart Printer; 1700 pieces on roll; stretchable 5 - 5.2 mm; plain; snap-on type; gray	 <b>Item No.: 2009-145/000-023</b> Mini-WSB Inline; for Smart Printer; 1700 pieces on roll; stretchable 5 - 5.2 mm; plain; snap-on type; green	 <b>Item No.: 2009-145/000-012</b> Mini-WSB Inline; for Smart Printer; 1700 pieces on roll; stretchable 5 - 5.2 mm; plain; snap-on type; orange
 <b>Item No.: 2009-145/000-005</b> Mini-WSB Inline; for Smart Printer; 1700 pieces on roll; stretchable 5 - 5.2 mm; plain; snap-on type; red	 <b>Item No.: 2009-145/000-024</b> Mini-WSB Inline; for Smart Printer; 1700 pieces on roll; stretchable 5 - 5.2 mm; plain; snap-on type; violet	 <b>Item No.: 2009-145</b> Mini-WSB Inline; for Smart Printer; 1700 pieces on roll; stretchable 5 - 5.2 mm; plain; snap-on type; white	 <b>Item No.: 2009-145/000-002</b> Mini-WSB Inline; for Smart Printer; 1700 pieces on roll; stretchable 5 - 5.2 mm; plain; snap-on type; yellow
 <b>Item No.: 248-501/000-006</b> Mini-WSB marking card; as card; not stretchable; plain; snap-on type; blue	 <b>Item No.: 248-501/000-007</b> Mini-WSB marking card; as card; not stretchable; plain; snap-on type; gray	 <b>Item No.: 248-501/000-023</b> Mini-WSB marking card; as card; not stretchable; plain; snap-on type; green	 <b>Item No.: 248-501/000-017</b> Mini-WSB marking card; as card; not stretchable; plain; snap-on type; light green

1.2.6.2 Marker



**Item No.: 248-501/000-012**

Mini-WSB marking card; as card; not stretchable; plain; snap-on type; orange

**Item No.: 248-501/000-005**

Mini-WSB marking card; as card; not stretchable; plain; snap-on type; red

**Item No.: 248-501/000-024**

Mini-WSB marking card; as card; not stretchable; plain; snap-on type; violet

**Item No.: 248-501**

Mini-WSB marking card; as card; not stretchable; plain; snap-on type; white



**Item No.: 248-501/000-002**

Mini-WSB marking card; as card; not stretchable; plain; snap-on type; yellow

**Item No.: 793-5501/000-006**

WMB marking card; as card; for terminal block width 5 - 17.5 mm; stretchable 5 - 5.2 mm; plain; snap-on type; blue

**Item No.: 793-5501/000-014**

WMB marking card; as card; for terminal block width 5 - 17.5 mm; stretchable 5 - 5.2 mm; plain; snap-on type; brown

**Item No.: 793-5501/000-007**

WMB marking card; as card; for terminal block width 5 - 17.5 mm; stretchable 5 - 5.2 mm; plain; snap-on type; gray



**Item No.: 793-5501/000-023**

WMB marking card; as card; for terminal block width 5 - 17.5 mm; stretchable 5 - 5.2 mm; plain; snap-on type; green

**Item No.: 793-5501/000-017**

WMB marking card; as card; for terminal block width 5 - 17.5 mm; stretchable 5 - 5.2 mm; plain; snap-on type; light green

**Item No.: 793-5501/000-012**

WMB marking card; as card; for terminal block width 5 - 17.5 mm; stretchable 5 - 5.2 mm; plain; snap-on type; orange

**Item No.: 793-5501/000-005**

WMB marking card; as card; for terminal block width 5 - 17.5 mm; stretchable 5 - 5.2 mm; plain; snap-on type; red



**Item No.: 793-5501/000-024**

WMB marking card; as card; for terminal block width 5 - 17.5 mm; stretchable 5 - 5.2 mm; plain; snap-on type; violet

**Item No.: 793-5501**

WMB marking card; as card; for terminal block width 5 - 17.5 mm; stretchable 5 - 5.2 mm; plain; snap-on type; white

**Item No.: 793-5501/000-002**

WMB marking card; as card; for terminal block width 5 - 17.5 mm; stretchable 5 - 5.2 mm; plain; snap-on type; yellow

**Item No.: 2009-115/000-006**

WMB-Inline; for Smart Printer; 1500 pieces on roll; stretchable 5 - 5.2 mm; plain; snap-on type; blue



**Item No.: 2009-115/000-007**

WMB-Inline; for Smart Printer; 1500 pieces on roll; stretchable 5 - 5.2 mm; plain; snap-on type; gray

**Item No.: 2009-115/000-023**

WMB-Inline; for Smart Printer; 1500 pieces on roll; stretchable 5 - 5.2 mm; plain; snap-on type; green

**Item No.: 2009-115/000-017**

WMB-Inline; for Smart Printer; 1500 pieces on roll; stretchable 5 - 5.2 mm; plain; snap-on type; light green

**Item No.: 2009-115/000-012**

WMB-Inline; for Smart Printer; 1500 pieces on roll; stretchable 5 - 5.2 mm; plain; snap-on type; orange



**Item No.: 2009-115/000-005**

WMB-Inline; for Smart Printer; 1500 pieces on roll; stretchable 5 - 5.2 mm; plain; snap-on type; red

**Item No.: 2009-115/000-024**

WMB-Inline; for Smart Printer; 1500 pieces on roll; stretchable 5 - 5.2 mm; plain; snap-on type; violet

**Item No.: 2009-115**

WMB-Inline; for Smart Printer; 1500 pieces on roll; stretchable 5 - 5.2 mm; plain; snap-on type; white

**Item No.: 2009-115/000-002**

WMB-Inline; for Smart Printer; 1500 pieces on roll; stretchable 5 - 5.2 mm; plain; snap-on type; yellow

1.2.6.3 Marker carrier



**Item No.: 2002-161**

Adaptor; gray

**Item No.: 2009-198**

Adaptor; gray

1.2.6.4 Marking strip



**Item No.: 2009-110**

Marking strips; for Smart Printer; on reel; not stretchable; plain; snap-on type; white

1.2.7 Plug

1.2.7.1 Component module with diode



**Item No.: 2002-880/1000-411**

Component plug; 2-pole; with diode 1N4007; 10.4 mm wide; Operating temperature 85°C max.; gray



1.2.7.2 Component module with LED



**Item No.: 2002-880/1000-541**

Component plug; 2-pole; LED (red); 10.4 mm wide; Operating temperature 85°C max.; gray

**Item No.: 2002-880/1000-836**

Component plug; 2-pole; LED (red); 10.4 mm wide; Operating temperature 85°C max.; gray

**Item No.: 2002-880/1000-542**

Component plug; 2-pole; LED (red); 10.4 mm wide; Operating temperature 85°C max.; multicoloured

1.2.7.3 Empty component plug housing



**Item No.: 2002-880**

Empty component plug housing; 10.4 mm wide; 2-pole; Type 4; gray

1.2.8 Protective warning marker

1.2.8.1 Cover



**Item No.: 2002-115**

Protective warning marker; for 5 terminal blocks; with high-voltage symbol, black; yellow

1.2.9 Push-in type wire jumper

1.2.9.1 Jumper



**Item No.: 2009-414**

Push-in type wire jumper; 1.5 mm<sup>2</sup>; insulated; 110 mm long; black



**Item No.: 2009-414/000-005**

Push-in type wire jumper; 1.5 mm<sup>2</sup>; insulated; 110 mm long; black



**Item No.: 2009-416**

Push-in type wire jumper; 1.5 mm<sup>2</sup>; insulated; 250 mm long; black



**Item No.: 2009-414/000-006**

Push-in type wire jumper; insulated; 110 mm long; black



**Item No.: 2009-412**

Push-in type wire jumper; insulated; 60 mm long; black

1.2.10 Screwless end stop

1.2.10.1 Mounting accessories



**Item No.: 249-117**

Screwless end stop; 10 mm wide; for DIN-rail 35 x 15 and 35 x 7.5; gray



**Item No.: 249-116**

Screwless end stop; 6 mm wide; for DIN-rail 35 x 15 and 35 x 7.5; gray

1.2.11 Test and measurement

1.2.11.1 Testing accessories



**Item No.: 2002-560**  
Modular TOPJOB®S connector; modular; for jumper contact slot; 10-pole; 2,50 mm<sup>2</sup>; gray



**Item No.: 2002-511**  
Modular TOPJOB®S connector; modular; for jumper contact slot; 1-pole; 2,50 mm<sup>2</sup>; gray



**Item No.: 2002-552**  
Modular TOPJOB®S connector; modular; for jumper contact slot; 2-pole; 2,50 mm<sup>2</sup>; gray



**Item No.: 2002-553**  
Modular TOPJOB®S connector; modular; for jumper contact slot; 3-pole; 2,50 mm<sup>2</sup>; gray



**Item No.: 2002-554**  
Modular TOPJOB®S connector; modular; for jumper contact slot; 4-pole; 2,50 mm<sup>2</sup>; gray



**Item No.: 2002-555**  
Modular TOPJOB®S connector; modular; for jumper contact slot; 5-pole; 2,50 mm<sup>2</sup>; gray



**Item No.: 2002-556**  
Modular TOPJOB®S connector; modular; for jumper contact slot; 6-pole; 2,50 mm<sup>2</sup>; gray



**Item No.: 2002-557**  
Modular TOPJOB®S connector; modular; for jumper contact slot; 7-pole; 2,50 mm<sup>2</sup>; gray



**Item No.: 2002-558**  
Modular TOPJOB®S connector; modular; for jumper contact slot; 8-pole; 2,50 mm<sup>2</sup>; gray



**Item No.: 2002-559**  
Modular TOPJOB®S connector; modular; for jumper contact slot; 9-pole; 2,50 mm<sup>2</sup>; gray



**Item No.: 2002-549**  
Spacer module; modular; e.g., for bridging commoned terminal blocks; gray



**Item No.: 2009-174**  
Test plug adapter; for 4 mm Ø test plugs; for testing TOPJOB®S rail-mounted terminal blocks; gray



**Item No.: 2009-182**  
Testing tap; for max. 2.5 mm<sup>2</sup>; tool-free connection for individual test wires 0.08 - 2.5 mm; gray



**Item No.: 2002-649**  
TOPJOB®S L-type spacer module; modular; e.g., for bridging commoned terminal blocks; gray



**Item No.: 2002-611**  
TOPJOB®S L-type test plug module; modular; 1-pole; 2,50 mm<sup>2</sup>; gray

1.2.12 Tool

1.2.12.1 Operating tool



**Item No.: 210-658**  
Operating tool; Blade: 3.5 x 0.5 mm; with a partially insulated shaft; angled; short; multicoloured



**Item No.: 210-720**  
Operating tool; Blade: 3.5 x 0.5 mm; with a partially insulated shaft; multicoloured

Installation Notes

Conductor termination



All conductor types at a glance

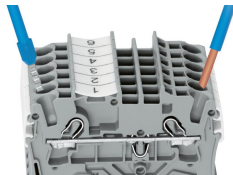

Push-in termination of solid and ferruled conductors

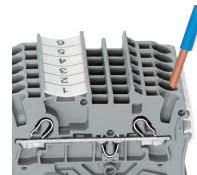

**Inserting a conductor via push-in termination:**  
Solid conductors with cross-sections from either one size above, or up to two sizes below, the rated cross-section can be simply pushed in – no tools needed.

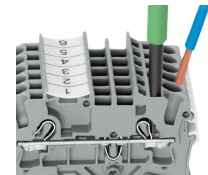

**Inserting a conductor via operating tool:**  
Connecting fine-stranded conductors without ferrules, or small cross-sectional conductors that cannot be pushed in, is performed similarly to the original CAGE CLAMP® – just use an operating tool.  
**Advantage:**  
To open the clamp, the operating tool is inserted vertically. The conductor entry is less than 15 degrees for easier wiring.

Commoning

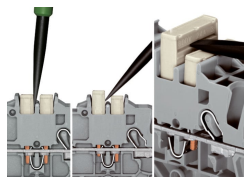
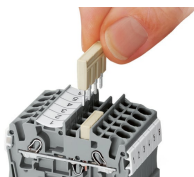

Insert push-in type jumper bar and push down until it hits backstop.

**Removing a push-in type jumper bar:** Insert the operating tool between the jumper and partition wall of the dual jumper slots, then lift up the jumper. Place the operating tool in the center of jumpers for up to five contacts (see above), or alternately on both sides for jumpers with more than five contacts.

Commoning

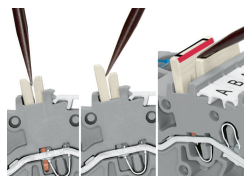
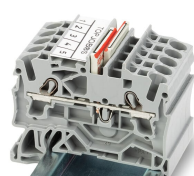

Orient the staggered jumpers' red stripes on the inside. Insert the staggered jumper and push down until it hits the backstop.

**Removing a staggered jumper:** Insert the operating tool between the staggered jumpers, then lift up the jumper.

Commoning

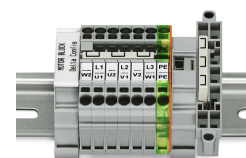
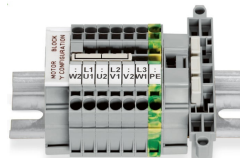
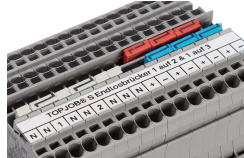
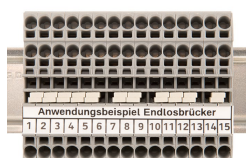

Continuous jumpers (2002 Series) readily connect an endless number of terminal blocks to each other via single jumper slot. Use the second jumper slot for additional commoning or testing.

The 1-to-3 adjacent jumper for continuous commoning enables every other terminal block to be commoned. For example, positive and negative potentials can be accommodated alongside each other.

This star point jumper has been specially developed to create a "star point" and is used on motor terminal boards equipped with Rail-Mount Terminal Blocks TOPJOB® S.

This delta jumper has been specially developed to create a delta configuration and is used on motor terminal boards equipped with rail-mount terminal blocks TOPJOB® S.

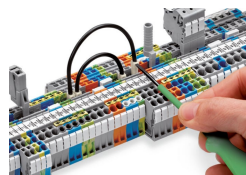

Push down the wire jumper until fully inserted. Lift the jumper with an operating tool for rewiring.

**Commoning**

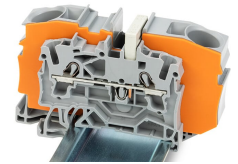
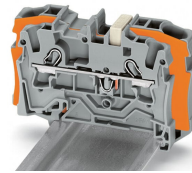
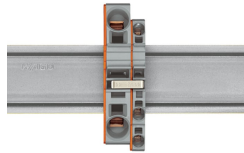
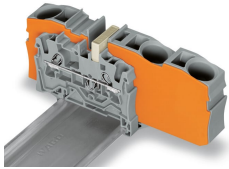

Step-down jumpers common terminal blocks of different sizes, without losing a conductor clamping point. This can be beneficial on long conductor runs where voltage drop can be a problem. A large conductor can be easily connected to smaller conductors at the distribution point. Commoning may be made in either direction using the special thin end plate to cover the open side. Additional through terminal blocks having a smaller cross-section may be commoned using push-in type jumper bars.

**Using step-down jumpers**, an end plate must be inserted between the terminal blocks to be commoned.

**Step-down jumper (2006-499)** commons 6/4 mm<sup>2</sup> (10/12 AWG) terminal blocks (2006/2004 Series) with 4/2.5/1.5 mm<sup>2</sup> (AWG 12/14/16) terminal blocks (2004/2002/2001 Series).

**Step-down jumper (2016-499)** commons 16/10 mm<sup>2</sup> (16/8 AWG) terminal blocks (2016/2010 Series) with 10/6/4/2.5 mm<sup>2</sup> (8/10/12/14 AWG) terminal blocks (2010/2006/2004/2002 Series).

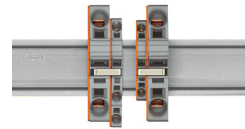
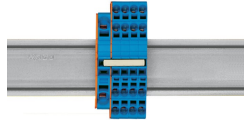
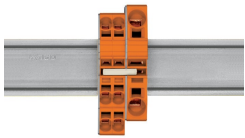

**Stepping down via push-in type jumper bar:** Commoning via open terminal side with end plate allows jumpering over two cross-section sizes for 16 mm<sup>2</sup> (6 AWG) and 10 mm<sup>2</sup> (8 AWG) and one cross-section size for 6/4/2.5 mm<sup>2</sup> (10/12/14 AWG). An example: from 16 mm<sup>2</sup> (6 AWG) to 6 mm<sup>2</sup> (10 AWG) (see illustration above) or from 10 mm<sup>2</sup> (8 AWG) to 4 mm<sup>2</sup> (12 AWG).

**Stepping down via push-in type jumper bar:** Commoning via closed terminal side with end plate allows jumpering over two cross-section sizes, e.g., from 16 mm<sup>2</sup> (6 AWG) to 6 mm<sup>2</sup> (10 AWG) or from 6 mm<sup>2</sup> (10 AWG) to 2.5 mm<sup>2</sup> (14 AWG) (see illustration above).

**Note:** The total current of the outgoing circuits must not exceed the nominal current of the step-down jumper/push-in type jumper bar.

**Testing**

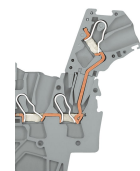
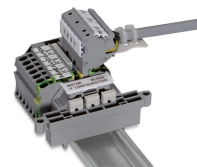
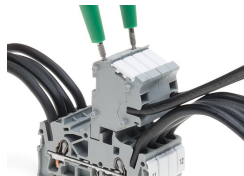

The modular TOPJOB® S connectors also connect conductors of the same size as the terminal blocks being used.

TOPJOB® S Connectors with a 2 mm Ø test socket for testing voltage via 2-pole voltage tester

Rail-mount terminal block assembly for electric motor wiring

L-type test plug module – cross-sectional view of contacts



Test plug adapter (2009-174, CAT I) for 4 mm Ø plugs – compatible with 2000 to 2016 Series

Testing tap (2009-182) for tool-free connection of test cables up to 2.5 mm<sup>2</sup> (12 AWG) – compatible with 2000 to 2016 Series

Marking

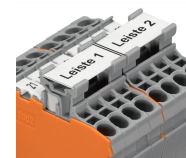
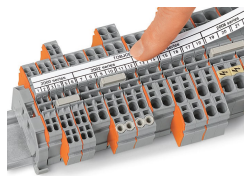
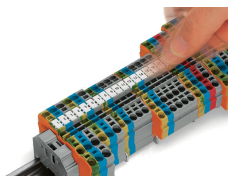

Snapping WMB Inline markers into marker slots.

TOPJOB® S 2009-193 Group Marker Carrier (equipped with a marking strip) for all 2001 to 2016 Series TOPJOB® S Rail-Mount Terminal Blocks  
Do not use on an end plate!

Using marker carriers for marking strips (2002-161) in jumper slots.

Ex application

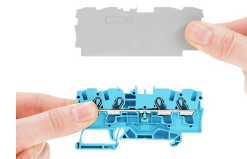
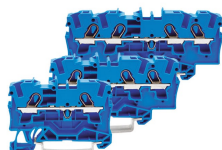
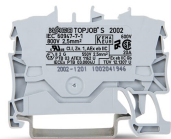

Through terminal blocks with a blue insulated housing are suitable for Ex i applications.

All through and ground conductor terminal blocks are suitable for Ex e II applications.

**Separator plate for Ex e/Ex i applications**

An end plate must be applied to the terminal block located directly behind an Ex e/Ex i separator plate.

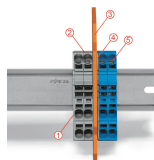

**Ex e II/Ex i terminal strip**

**Note:**  
The movable feet of terminal blocks and separator plates must face the same direction.

A separator plate is located between the Ex e II and Ex i terminal strip.

- End plate
- Ex e II terminal blocks
- Separator plate for Ex e/Ex i applications
- End plate
- Ex i terminal blocks

According to EN 50020, a minimum distance of 50 mm must be kept between live parts of Ex e and Ex i circuits. The use of Ex e/Ex i separators is a space-saving solution when Ex e and Ex i terminal blocks are mounted on a common DIN-rail.