

FEATURES

- **Large capacity in small size:**
10 A 250 V AC (1a)
- **High sensitivity:**
200 mW nominal operating power
- **High breakdown voltage 4,000 Vrms between contacts and coil 1,000 Vrms between open contacts Meeting FCC Part 68**
- **Sealed construction**
- **Latching types available**

About Cd-free contacts

We have introduced Cadmium free type products to reduce Environmental Hazardous Substances. (The suffix "F" should be added to the part number) (Note: The Suffix "F" is required only for 1 Form A contact type. The 2 Form A and 1 Form A 1 Form B contact type is originally Cadmium free, the suffix "F" is not required.) Please replace parts containing Cadmium with Cadmium-free products and evaluate them with your actual application before use because the life of a relay depends on the contact material and load.

SPECIFICATIONS

Contact

Arrangement	1 Form A	2 Form A, 1 Form A 1 Form B	
Initial contact resistance, max. (By voltage drop 6 V DC 1A)	30 mΩ		
Contact material	AgSnO ₂ type		
Rating (resistive)	Nominal switching capacity	10 A 250 V AC 10 A 30 V DC	8 A 250 V AC 8 A 30 V DC
	Max. switching power	300 W, 2,500 VA	240 W, 2,000 VA
	Max. switching voltage	250 V AC, 30 V DC	250 V AC, 30 V DC
	Max. switching current	10 A	8 A
	Min. switching capacity ^{#1}	10 mA, 5 V DC	
Expected life (min. operations)	Mechanical	5×10 ⁷	
	Electrical (resistive)	10 ⁵ (10 A 250 V AC, 10 A 30 V DC)	10 ⁵ (8 A 250 V AC, 8 A 30 V DC)

Coil

Nominal operating power	200 mW
-------------------------	--------

#1 This value can change due to the switching frequency, environmental conditions, and desired reliability level, therefore it is recommended to check this with the actual load.

Remarks

- * Specifications will vary with foreign standards certification ratings.
- *¹ Measurement at same location as "Initial breakdown voltage" section
- *² Detection current: 10 mA
- *³ Wave is standard shock voltage of $\pm 1.2 \times 50\mu\text{s}$ according to JEC-212-1981
- *⁴ Excluding contact bounce time
- *⁵ Half-wave pulse of sine wave: 11ms; detection time: 10 μs
- *⁶ Half-wave pulse of sine wave: 6ms
- *⁷ Detection time: 10 μs
- *⁸ Refer to 6. Conditions for operation, transport and storage mentioned in [AMBIENT ENVIRONMENT \(p. 19, Relay Technical Information\)](#).

Characteristics

Max. operating speed	20 cpm (at rated load)	
Initial insulation resistance ^{*1}	Min. 1,000 mΩ (at 500 V DC)	
Initial breakdown voltage ^{*2}	Between open contacts	1,000 Vrms
	Between contacts and coil	4,000 Vrms
Surge voltage between coil and contact ^{*3}	Min. 10,000 V	
Operate time ^{*4} (at nominal voltage)	Max. 10 ms (Approx. 5 ms)	
Release time (without diode) ^{*4} (at nominal voltage)	Max. 8 ms (Approx. 3 ms)	
Temperature rise (at nominal voltage)	Max. 40°C with nominal coil voltage and at 10 A switching current	
Shock resistance	Functional ^{*5}	Min. 98 m/s ² {10 G}
	Destructive ^{*6}	Min. 980 m/s ² {100 G}
Vibration resistance	Functional ^{*7}	88.2 m/s ² {9 G}, 10 to 55 Hz at double amplitude of 1.5 mm
	Destructive	176.4 m/s ² {18 G}, 10 to 55 Hz at double amplitude of 3.0 mm
Conditions for operation, transport and storage ^{*8} (Not freezing and condensing at low temperature)	Ambient temp.	-40°C to +65°C -40°F to +149°F
	Humidity	5 to 85% R.H.
Unit weight	1 Form A	Approx. 5.6 g .20 oz
	1 Form A 1 Form B, 2 Form A	Approx. 6 g .21 oz

TYPICAL APPLICATIONS

- Switching power supply
- Power switching for various OA equipment
- Control or driving relays for industrial machines (robotics, numerical control machines, etc.)
- Output relays for programmable logic controllers, temperature controllers, timers and so on.
- Home appliances

ORDERING INFORMATION

Ex. DK 1a — L2 — 12V — F

Contact arrangement	Operating function	Coil voltage	Contact material
1a: 1 Form A 2a: 2 Form A 1a1b: 1 Form A 1 Form B	Nil: Single side stable L2: 2 coil latching	3, 5, 6, 9, 12, 24V	• AgSnO ₂ type F: 1a Nil: 2a, 1a1b

- Notes: 1. Standard packing Carton: 50 pcs.; Case: 500 pcs.
UL/CSA, TÜV approved type is standard.
2. 1 coil latching type available.
3. Please inquire about the previous products (Cadmium containing parts).
(1 Form A type only)

TYPES AND COIL DATA (at 20°C 68°F)

Single side stable

	Part No.	Nominal voltage, V DC	Pick-up voltage, V DC (max.)	Drop-out voltage, V DC (min.)	Nominal operating current, mA (±10%)	Coil resistance, Ω (±10%)	Nominal operating power, mW	Maximum allowable voltage, V DC (at 65°C 149°F)
1 Form A	DK1a-3V-F	3	2.1	0.3	66.6	45	200	3.9
	DK1a-5V-F	5	3.5	0.5	40	125	200	6.5
	DK1a-6V-F	6	4.2	0.6	33.3	180	200	7.8
	DK1a-9V-F	9	6.3	0.9	22.2	405	200	11.7
	DK1a-12V-F	12	8.4	1.2	16.6	720	200	15.6
	DK1a-24V-F	24	16.8	2.4	8.3	2,880	200	31.2
1 Form A 1 Form B	DK1a1b-3V	3	2.1	0.3	66.6	45	200	3.9
	DK1a1b-5V	5	3.5	0.5	40	125	200	6.5
	DK1a1b-6V	6	4.2	0.6	33.3	180	200	7.8
	DK1a1b-9V	9	6.3	0.9	22.2	405	200	11.7
	DK1a1b-12V	12	8.4	1.2	16.6	720	200	15.6
	DK1a1b-24V	24	16.8	2.4	8.3	2,880	200	31.2
2 Form A	DK2a-3V	3	2.1	0.3	66.6	45	200	3.9
	DK2a-5V	5	3.5	0.5	40	125	200	6.5
	DK2a-6V	6	4.2	0.6	33.3	180	200	7.8
	DK2a-9V	9	6.3	0.9	22.2	405	200	11.7
	DK2a-12V	12	8.4	1.2	16.6	720	200	15.6
	DK2a-24V	24	16.8	2.4	8.3	2,880	200	31.2

2 coil latching

	Part No.	Nominal voltage, V DC	Set voltage, V DC (max.)	Reset voltage, V DC (max.)	Nominal operating current, mA (±10%)		Coil resistance, Ω (±10%)		Nominal operating power, mW		Maximum allowable voltage, V DC (at 65°C 149°F)
					Set	Reset	Set	Reset	Set	Reset	
1 Form A	DK1a-L2-3V-F	3	2.1	2.1	66.6	66.6	45	45	200	200	3.9
	DK1a-L2-5V-F	5	3.5	3.5	40	40	125	125	200	200	6.5
	DK1a-L2-6V-F	6	4.2	4.2	33.3	33.3	180	180	200	200	7.8
	DK1a-L2-9V-F	9	6.3	6.3	22.2	22.2	405	405	200	200	11.7
	DK1a-L2-12V-F	12	8.4	8.4	16.6	16.6	720	720	200	200	15.6
	DK1a-L2-24V-F	24	16.8	16.8	8.3	8.3	2,880	2,880	200	200	31.2
1 Form A 1 Form B	DK1a1b-L2-3V	3	2.1	2.1	66.6	66.6	45	45	200	200	3.9
	DK1a1b-L2-5V	5	3.5	3.5	40	40	125	125	200	200	6.5
	DK1a1b-L2-6V	6	4.2	4.2	33.3	33.3	180	180	200	200	7.8
	DK1a1b-L2-9V	9	6.3	6.3	22.2	22.2	405	405	200	200	11.7
	DK1a1b-L2-12V	12	8.4	8.4	16.6	16.6	720	720	200	200	15.6
	DK1a1b-L2-24V	24	16.8	16.8	8.3	8.3	2,880	2,880	200	200	31.2
2 Form A	DK2a-L2-3V	3	2.1	2.1	66.6	66.6	45	45	200	200	3.9
	DK2a-L2-5V	5	3.5	3.5	40	40	125	125	200	200	6.5
	DK2a-L2-6V	6	4.2	4.2	33.3	33.3	180	180	200	200	7.8
	DK2a-L2-9V	9	6.3	6.3	22.2	22.2	405	405	200	200	11.7
	DK2a-L2-12V	12	8.4	8.4	16.6	16.6	720	720	200	200	15.6
	DK2a-L2-24V	24	16.8	16.8	8.3	8.3	2,880	2,880	200	200	31.2

REFERENCE DATA

1. 1 Form A type

1. Maximum operating power

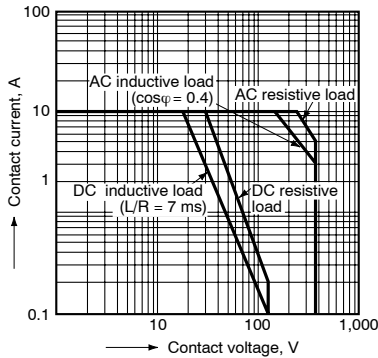

2. Life curve

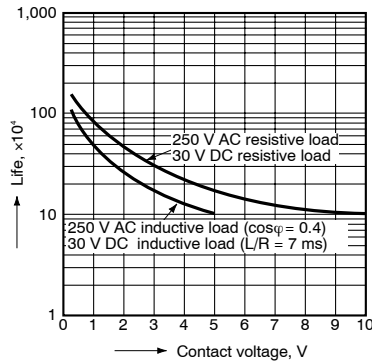

3. Operate/Release time

Sample: DK1a-24V, 5 pcs.

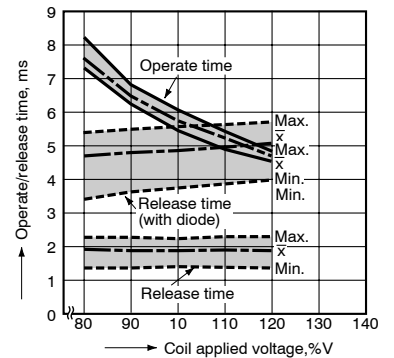

4. Coil temperature rise (at 30°C 68°F)

Sample: DK1a-12V, 5 pcs.

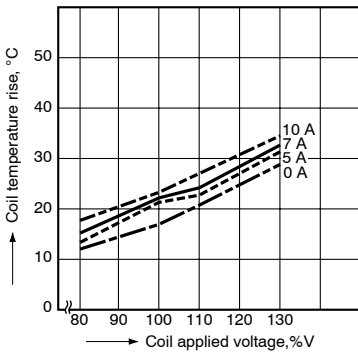

5. Ambient temperature characteristics

Sample: DK1a-24V, 6 pcs

Ambient temperature: -40°C to +80°C
-40°F to +176°F

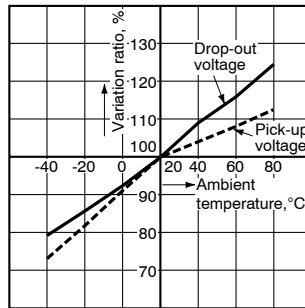

6. Operate/Release time (at 20°C 68°F)

Sample: DK1a-24V (50 pcs.)

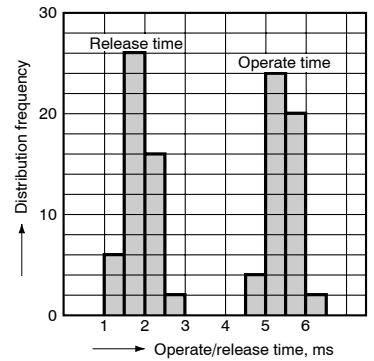

7. Contact resistance (at 20°C 68°F)

Sample: DK1a-24V (50 pcs.)

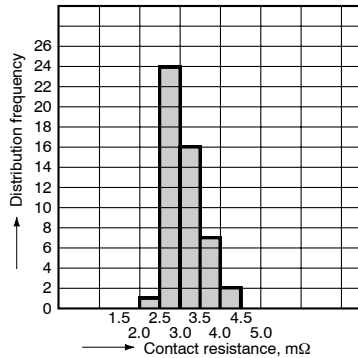

2. 1 Form A 1 Form B type, 2 Form A type 1. 1 Form A type

1. Maximum operating power

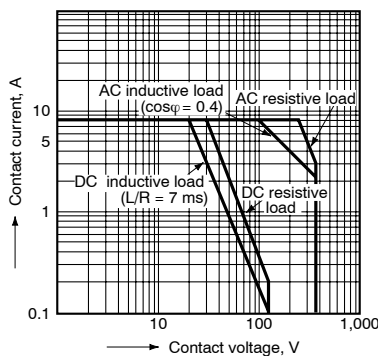

2. Life curve

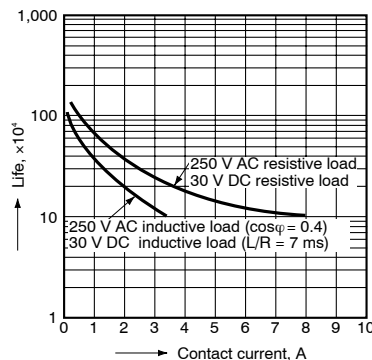

3. Operate/Release time (at 20°C 68°F)

Sample: DK1a1b-12V, 5 pcs.

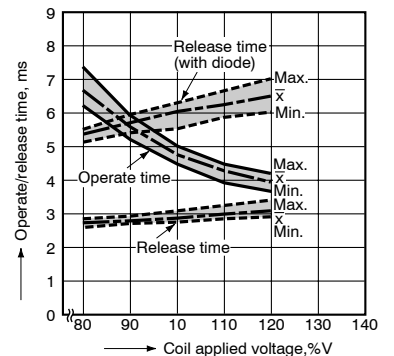

4. Coil temperature rise

Sample: DK1a1b-12V, 5 pcs.
Ambient temperature: 20°C 68°F

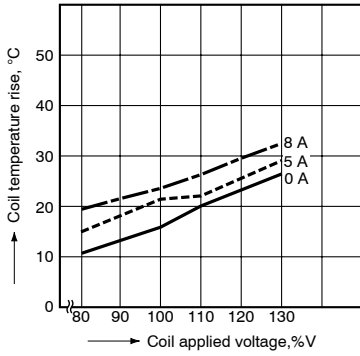

5. Ambient temperature characteristics

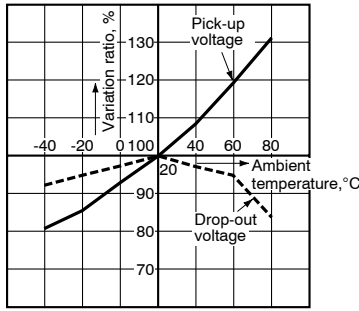

DIMENSIONS

mm inch

1. 1 Form A type

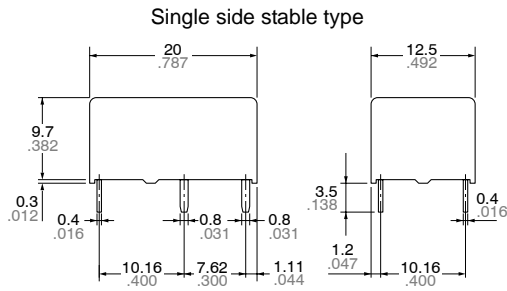

PC board pattern (Copper-side view)

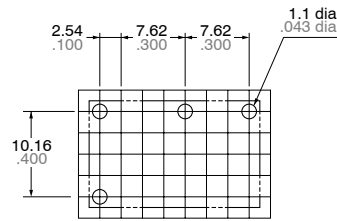

Schematic (Bottom view)
Single side stable
(Deenergized condition)

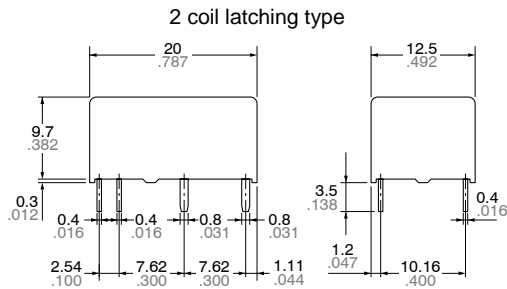
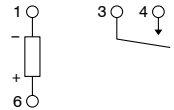

PC board pattern (Copper-side view)

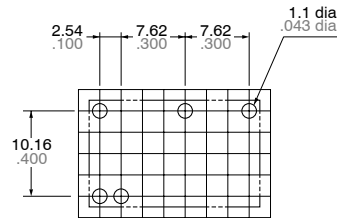

2 coil latching
(Reset condition)

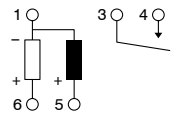

The above shows 2 coil latching type.
No.5 terminal is eliminated on single side stable type.

Since this is a polarized relay, the connection to the coil should be done according to the above schematic.

General tolerance: $\pm 0.3 \pm .012$

Tolerance: $\pm 0.1 \pm .004$

2. 1 Form A 1 Form B type, 2 Form A type

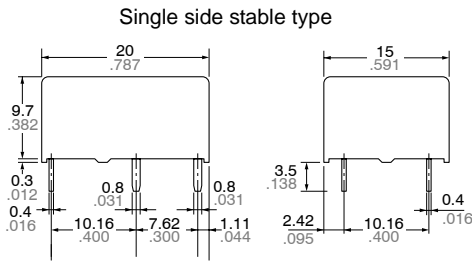

PC board pattern (Copper-side view)

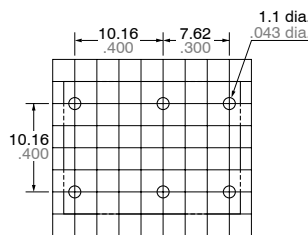

Schematic (Bottom view)
<1 Form A 1 Form B type>
Single side stable
(Deenergized condition) 2 coil latching
(Reset condition)

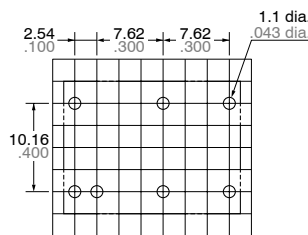
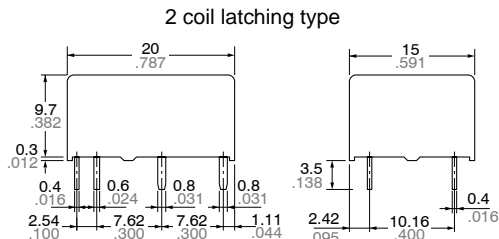
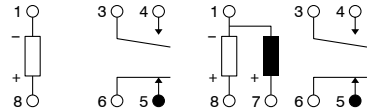

<2 Form A>
Single side stable
(Deenergized condition) 2 coil latching
(Reset condition)

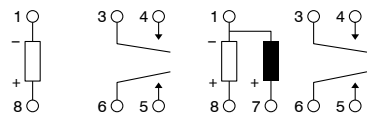

Since this is a polarized relay, the connection to the coil should be done according to the above schematic.

Note:

Relay out-line and PC board pattern are common for both 1 Form A 1 Form B type and 2 Form A type.

General tolerance: $\pm 0.3 \pm .012$

Tolerance: $\pm 0.1 \pm .004$

DK relay socket



TYPES AND RELAY COMPATIBILITY

Relay		Socket	1 Form A		1 Form A 1 Form B, 2 Form A	
			Single side stable type	2 coil latching type	Single side stable type	2 coil latching type
1 Form A	Single side stable type		DK1a-PS	DK1a-PSL2	—	—
	2 coil latching type		—	DK1a-PSL2	—	—
1 Form A 1 Form B 2 Form A	Single side stable type		—	—	DK2a-PS	DK2a-PSL2
	2 coil latching type		—	—	—	DK2a-PSL2

SPECIFICATIONS

Breakdown voltage*1	4,000 Vrms (Except the portion between coil terminals)
Insulation resistance	Min. 1,000 mΩ (at 500 V DC)
Heat resistance	150°C (for 1 hour)
Max. continuous current	10 A (DK1a-PS, DK1a-PSL2), 8 A (DK2a-PS, DK2a-PSL2)

Remarks

*1 Detection current: 10 mA

DIMENSIONS

mm inch

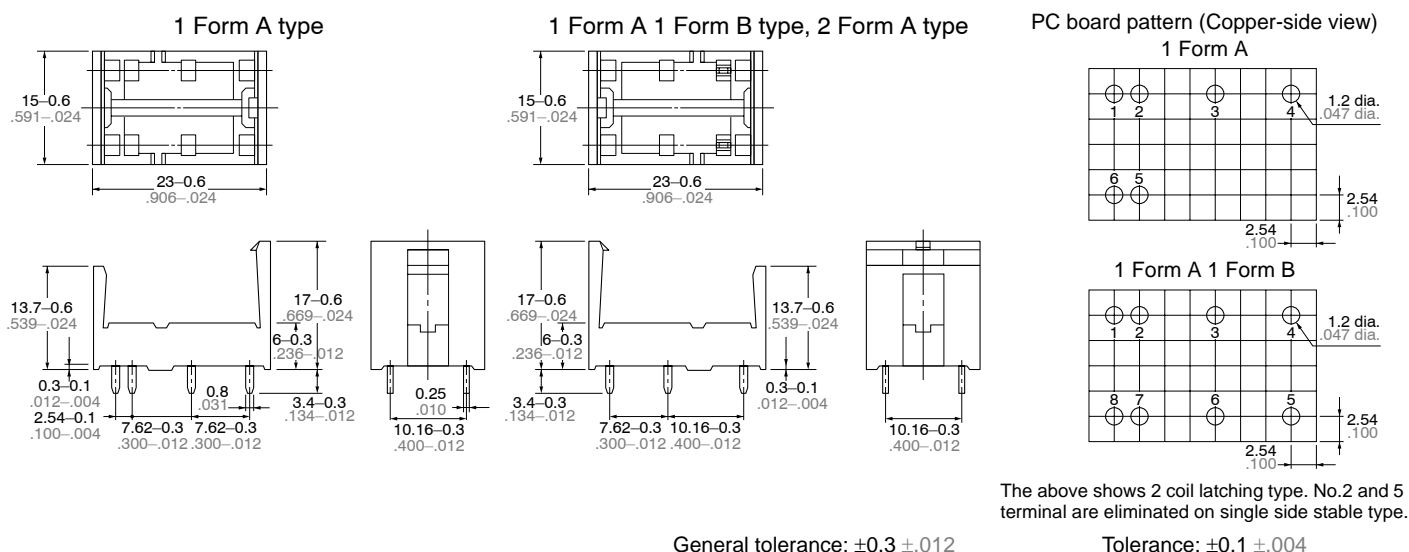

FIXING AND REMOVAL METHOD

1. Match the direction of relay and socket.
2. Both ends of the relay are to be secured firmly so that the socket hooks on the top surface of the relay.
3. Remove the relay, applying force in the direction shown below.
4. In case there is not enough space to grasp relay with fingers, use screwdrivers in the way shown below.

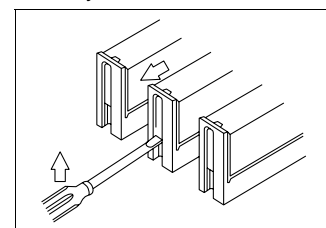
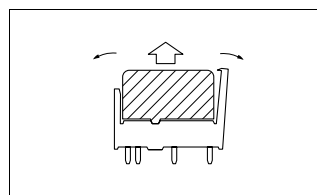
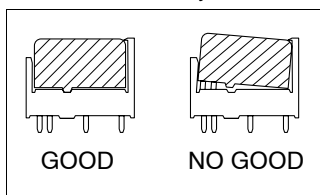
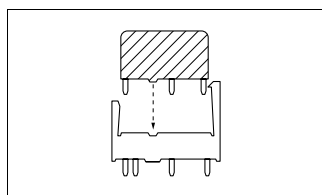

NOTES

1. Phase synchronization of AC-load switching
In case of switching the contact synchronized with phase of load voltage, the life of contact might be shorter or contact failure might be caused. Please confirm this matter in the actual system in this case. If necessary, the phase control would be recommended.

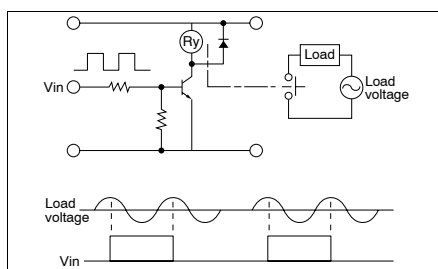

2. Soldering should be done under the following conditions:
250°C 482°F within 10s
300°C 572°F within 5s
350°C 662°F within 3s

For Cautions for Use, see [Relay Technical Information](#).