



## Features

- Radial leaded devices
- Cured, flame retardant epoxy polymer insulating material meets UL 94V-0 requirements
- Bulk packaging, tape and reel available
- Resettable circuit protection
- Agency recognition:  
- RoHS compliant\* and halogen free\*\*

## Applications

- Food blenders, coffee machines
- HVAC
- Electric fans, blowers
- AC adaptors

# MF-RM Series - PTC Resettable Fuses

## Electrical Characteristics

Model	Typical Current Trip Limit		V <sub>max</sub>		I <sub>max</sub>	Initial Resistance	One Hour Post-Trip Resistance	Max. Time to Trip		Tripped Power Dissipation
	I <sub>hold</sub> at 23 °C	I <sub>trip</sub> at 23 °C	Operating Voltage	Interrupt Voltage	Interrupt Current	R <sub>Min.</sub> at 23 °C	R <sub>1</sub> Max. at 23 °C	at 23 °C		PD Typ. at 23 °C
	(A)	(A)	(Vac)	(Vac)	(A)	(Ohms)	(Ohms)	(A)	(Sec.)	(W)
MF-RM005/240	0.05	0.12	240	265	1.0	18.50	65.00	0.25	10.0	0.9
MF-RM008/240	0.08	0.19	240	265	1.2	7.40	26.00	0.40	10.0	0.9
MF-RM012/240	0.12	0.30	240	265	1.2	3.00	12.00	0.60	15.0	1.0
MF-RM016/240	0.16	0.37	240	265	2.0	2.50	7.80	0.80	15.0	1.4
MF-RM025/240	0.25	0.56	240	265	3.5	1.30	3.80	1.25	18.5	1.5
MF-RM033/240	0.33	0.74	240	265	4.5	0.77	2.60	1.65	21.0	1.7
MF-RM040/240	0.40	0.90	240	265	5.5	0.60	1.90	2.00	24.0	2.0
MF-RM055/240	0.55	1.25	240	265	7.0	0.45	1.45	2.75	26.0	3.4

## Environmental Characteristics

Operating Temperature.....	-20 °C to +85 °C
Humidity Aging.....	+85 °C, 85 % R.H. 1000 hours .....±20 % typical resistance change
Passive Aging.....	+85 °C, 1000 hours.....±20 % typical resistance change
Vibration .....	MIL-STD-883C, Method 2007.1,.....No change Condition A
Solvent Resistance.....	MIL-STD-202, Method 215 .....No change

## Test Procedures And Requirements For Model MF-RM Series

Item	Test Conditions	Accept/Reject Criteria
Visual/Mechanical.....	Verify dimensions and material.....	Per MF physical description
Resistance.....	In still air @ 23 °C.....	R <sub>min</sub> ≤ R ≤ R <sub>1max</sub>
Time to Trip.....	240 Vac, specified current .....	T ≤ max. time to trip
Hold Current.....	At I <sub>hold</sub> .....	No trip
Trip Cycle Life.....	240 Vac, I <sub>max</sub> , 100 cycles .....	No arcing or burning
Trip Endurance .....	a) 240 Vac, I <sub>max</sub> , 24 hours .....	No arcing or burning
	b) 265 Vac, I <sub>max</sub> , 30 mins.	
Solderability.....	MIL-STD-202, Method 208 .....	95 % min. coverage

UL File Number .....E174545..... <http://www.ul.com/> Follow link to Certifications, then UL File No., enter E174545  
 TÜV Certificate Number .....50232433..... [http://www.tuvdotcom.com/certificates/50232433?locale=en&page\\_number=3](http://www.tuvdotcom.com/certificates/50232433?locale=en&page_number=3)

\* RoHS Directive 2002/95/EC Jan. 27, 2003 including annex and RoHS Recast 2011/65/EU June 8, 2011.

\*\* Bourns follows the prevailing definition of "halogen free" in the industry. Bourns considers a product to be "halogen free" if (a) the Bromine (Br) content is 900 ppm or less; (b) the Chlorine (Cl) content is 900 ppm or less; and (c) the total Bromine (Br) and Chlorine (Cl) content is 1500 ppm or less.

Specifications are subject to change without notice.

The device characteristics and parameters in this data sheet can and do vary in different applications and actual device performance may vary over time. Users should verify actual device performance in their specific applications.

## Advantages

- Resettable feature with overtemperature and overcurrent protection can save expensive components from having to be replaced after tripping, e.g., transformers with built in thermal fuses
- Faster than bimetallic switch designs that take on average approximately 30 seconds to cool down and reset
- Generally lower electromagnetic interference than bimetallic switches

## Benefits

- Reduced repair and replacement costs
- Reduced nuisance tripping
- Combined overcurrent and overtemperature protector in one device

# MF-RM Series - PTC Resettable Fuses

# BOURNS®

### Thermal Derating Chart - I<sub>hold</sub> (Amps)

Model	Ambient Operating Temperature							
	-20 °C	0 °C	23 °C	40 °C	50 °C	60 °C	70 °C	85 °C
MF-RM005/240	0.08	0.06	0.05	0.04	0.04	0.03	0.03	0.02
MF-RM008/240	0.12	0.10	0.08	0.07	0.06	0.05	0.04	0.03
MF-RM012/240	0.18	0.15	0.12	0.10	0.09	0.07	0.06	0.04
MF-RM016/240	0.24	0.20	0.16	0.13	0.11	0.10	0.08	0.05
MF-RM025/240	0.38	0.32	0.25	0.21	0.18	0.15	0.13	0.09
MF-RM033/240	0.50	0.42	0.33	0.27	0.23	0.20	0.17	0.11
MF-RM040/240	0.61	0.51	0.40	0.33	0.28	0.24	0.20	0.14
MF-RM055/240	0.80	0.68	0.55	0.46	0.40	0.35	0.29	0.22

### Product Dimensions

Model	A Max.	B Max.	C		D Min.	E Max.	Physical Characteristics		
			Nom.	Tol. ±			Style	Lead Dia.	Material
MF-RM005/240	8.3 (0.327)	12.9 (0.508)	5.1 (0.201)	0.7 (0.028)	7.6 (0.299)	3.8 (0.150)	1	0.51 (0.020)	Sn/Cu
MF-RM008/240	8.3 (0.327)	12.9 (0.508)	5.1 (0.201)	0.7 (0.028)	7.6 (0.299)	3.8 (0.150)	1	0.51 (0.020)	Sn/Cu
MF-RM012/240	8.3 (0.327)	12.9 (0.508)	5.1 (0.201)	0.7 (0.028)	7.6 (0.299)	3.8 (0.150)	1	0.51 (0.020)	Sn/Cu
MF-RM016/240	9.9 (0.390)	13.8 (0.543)	5.1 (0.201)	0.7 (0.028)	7.6 (0.299)	3.8 (0.150)	1	0.51 (0.020)	Sn/Cu
MF-RM025/240	10.0 (0.394)	20.0 (0.787)	5.1 (0.201)	0.7 (0.028)	7.6 (0.299)	3.8 (0.150)	2	0.65 (0.026)	Sn/Cu
MF-RM033/240	11.4 (0.449)	20.0 (0.787)	5.1 (0.201)	0.7 (0.028)	7.6 (0.299)	3.8 (0.150)	2	0.65 (0.026)	Sn/Cu
MF-RM040/240	11.5 (0.453)	20.9 (0.823)	5.1 (0.201)	0.7 (0.028)	7.6 (0.299)	3.8 (0.150)	2	0.65 (0.026)	Sn/Cu
MF-RM055/240	14.0 (0.551)	22.4 (0.882)	5.1 (0.201)	0.7 (0.028)	7.6 (0.299)	4.1 (0.161)	2	0.81 (0.032)	Sn/Cu

Packaging options:

BULK: 500 pcs. per bag.

TAPE & REEL: 2000 pcs. per reel (MF-RM005/240~MF-RM040/240); 1000 pcs. per reel (MF-RM055/240)

0.51 (24AWG)

0.65 (22AWG)

0.81 (20AWG)

DIMENSIONS:  $\frac{\text{MM}}{\text{(INCHES)}}$

#### Style 1

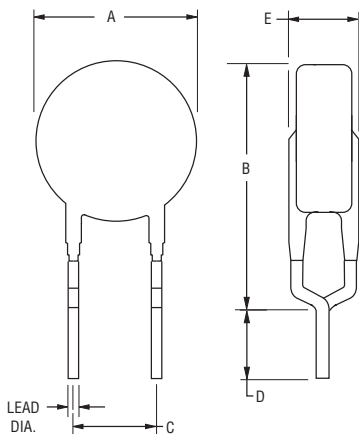

#### Style 2

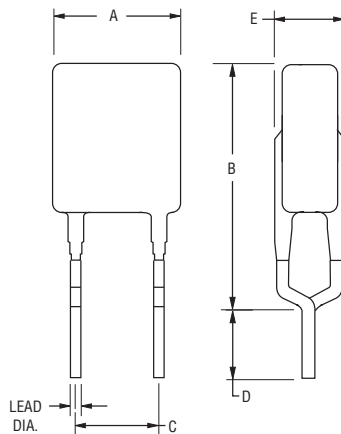

### Typical Part Marking

Represents total content. Layout may vary.

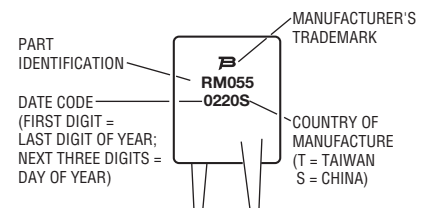

Specifications are subject to change without notice. The device characteristics and parameters in this data sheet can and do vary in different applications and actual device performance may vary over time. Users should verify actual device performance in their specific applications.

# MF-RM Series - PTC Resettable Fuses

**BOURNS®**

## Typical Time to Trip at 23 °C

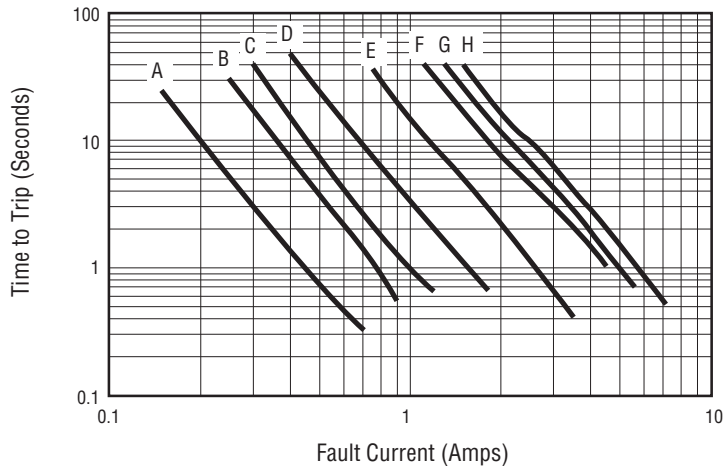

- A = MF-RM005/240
- B = MF-RM008/240
- C = MF-RM012/240
- D = MF-RM016/240
- E = MF-RM025/240
- F = MF-RM033/240
- G = MF-RM040/240
- H = MF-RM055/240

## How to Order

**MF - RM 005 / 240 - 2**

Multifuse®  
 Product Designator

Series \_\_\_\_\_  
 RM = Radial Leaded Component

Hold Current,  $I_{hold}$  \_\_\_\_\_  
 005-055 (0.05 Amps - 0.55 Amps)

Operating Voltage,  $V_{max}$  \_\_\_\_\_  
 240 = 240 Vac

Packaging Options \_\_\_\_\_  
 - 0 = Bulk Packaging  
 - 2 = Tape and Reel

\*Packaged per EIA486-B

# MF-RM Series Tape and Reel Specifications

**BOURNS®**

Devices taped using EIA468-B/IEC60286-2 standards. See table below and Figures 1 and 2 for details.

Dimension Description	IEC Mark	EIA Mark	Dimensions	
			Dimensions	Tolerance
Carrier tape width	$W$	$W$	$\frac{18}{(.709)}$	$\frac{-0.5/+1.0}{(-0.02/+0.039)}$
Hold down tape width	$W_0$	$W_4$	$\frac{11}{(.433)}$	min.
Hold down tape			No protrusion	
Top distance between tape edges	$W_2$	$W_6$	$\frac{3}{(.118)}$	max.
Sprocket hole position	$W_1$	$W_5$	$\frac{9}{(.354)}$	$\frac{-0.5/+0.75}{(-0.02/+0.03)}$
Sprocket hole diameter	$D_0$	$D_0$	$\frac{4}{(.157)}$	$\frac{\pm 0.2}{(\pm 0.079)}$
Abscissa to plane (MF-RM005/240~MF-RM016/240)	$H$	$H$	$\frac{18.5}{(.728)}$	$\frac{\pm 3.0}{(\pm .118)}$
Abscissa to plane (MF-RM025/240~MF-RM055/240)	$H_0$	$H_0$	$\frac{16}{(.63)}$	$\frac{\pm 0.5}{(\pm .02)}$
Abscissa to top (MF-RM005/240~MF-RM016/240)	$H_1$	$H_1$	$\frac{32.2}{(1.268)}$	max.
Abscissa to top (MF-RM025/240~MF-RM055/240)	$H_1$	$H_1$	$\frac{45.0}{(1.772)}$	max.
Overall width w/lead protrusion (MF-RM005/240~MF-RM016/240)		$C_1$	$\frac{43.2}{(1.701)}$	max.
Overall width w/lead protrusion (MF-RM025/240~MF-RM055/240)		$C_1$	$\frac{56.0}{(2.205)}$	max.
Overall width w/o lead protrusion (MF-RM005/240~MF-RM016/240)		$C_2$	$\frac{42.5}{(1.673)}$	max.
Overall width w/o lead protrusion (MF-RM025/240~MF-RM055/240)		$C_2$	$\frac{56.0}{(2.205)}$	max.
Lead protrusion	$l_1$	$L_1$	$\frac{1.0}{(.039)}$	max.
Protrusion of cutout	$L$	$L$	$\frac{11}{(.433)}$	max.
Protrusion beyond hold-down tape	$l_2$	$l_2$	Not specified	
Sprocket hole pitch	$P_0$	$P_0$	$\frac{12.7}{(.500)}$	$\frac{\pm 0.3}{(\pm .012)}$
Pitch tolerance			20 consecutive	$\frac{\pm 1}{(\pm .039)}$
Device pitch (MF-RM005/240-MF-RM040/240)			$\frac{12.7}{(.500)}$	$\frac{\pm 0.3}{(\pm .012)}$
Device pitch (MF-RM055/240)			$\frac{25.4}{(1.00)}$	$\frac{\pm 0.6}{(\pm .024)}$
Tape thickness	$t$	$t$	$\frac{0.9}{(.035)}$	max.
Tape thickness with splice (MF-RM005/240~MF-RM040/240)		$t_1$	$\frac{1.5}{(.059)}$	max.
Tape thickness with splice (MF-RM055/240)		$t_1$	$\frac{2.3}{(.091)}$	max.
Splice sprocket hole alignment			0	$\frac{\pm 0.3}{(\pm .012)}$
Body lateral deviation	$\Delta_h$	$\Delta_h$	0	$\frac{\pm 1}{(\pm .039)}$
Body tape plane deviation	$\Delta_p$	$\Delta_p$	0	$\frac{\pm 0.3}{(\pm .012)}$
Lead seating plane deviation	$\Delta P_1$	$P_1$	$\frac{3.81}{(.015)}$	$\frac{\pm 0.7}{(\pm .028)}$
Lead spacing	$F$	$F$	$\frac{5.08}{(.200)}$	$\frac{+0.8/-0.5}{(+.031/-0.020)}$

DIMENSIONS:  $\frac{\text{MM}}{\text{(INCHES)}}$

Specifications are subject to change without notice.

The device characteristics and parameters in this data sheet can and do vary in different applications and actual device performance may vary over time. Users should verify actual device performance in their specific applications.

# MF-RM Series Tape and Reel Specifications

**BOURNS®**

Dimension Description	IEC Mark	EIA Mark	Dimensions	
			Dimensions	Tolerance
Reel width (MF-RM005/240~MF-RM040/240)	<i>w</i>	<i>w</i> <sub>2</sub>	$\frac{56.0}{(2.20)}$	max.
Reel width (MF-RM055/240)	<i>w</i>	<i>w</i> <sub>2</sub>	$\frac{63.5}{(2.50)}$	max.
Reel diameter	<i>d</i>	<i>a</i>	$\frac{370.0}{(14.57)}$	max.
Space between flanges (MF-RM005/240~MF-RM040/240)	<i>h</i>	<i>w</i> <sub>1</sub>	$\frac{48.0}{(1.89)}$	max.
Space between flanges (MF-RM055/240)	<i>h</i>	<i>w</i> <sub>1</sub>	$\frac{55.0}{(2.17)}$	max.
Arbor hole diameter	<i>f</i>	<i>c</i>	$\frac{26.0}{(1.02)}$	$\frac{\pm 12.0}{(\pm 4.72)}$
Core diameter	<i>h</i>	<i>n</i>	$\frac{91.0}{(3.58)}$	max.
Box			$\frac{64}{(2.5)}$ $\frac{372}{(14.6)}$ $\frac{372}{(14.6)}$	max.
Consecutive missing places			3	max.
Empty places per reel			0.1 %	max.

DIMENSIONS:  $\frac{\text{MM}}{\text{(INCHES)}}$

**Taped Component Dimensions - Figure 1**

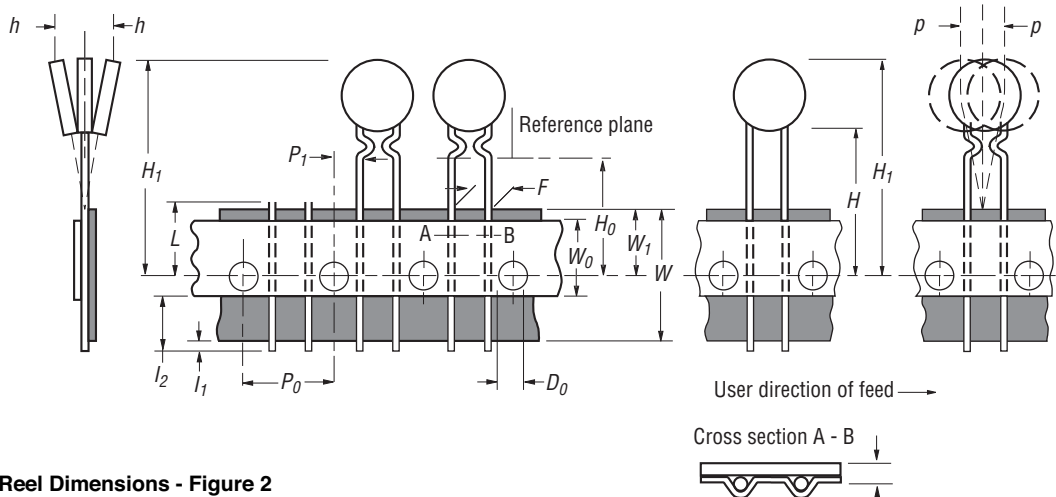

**Reel Dimensions - Figure 2**

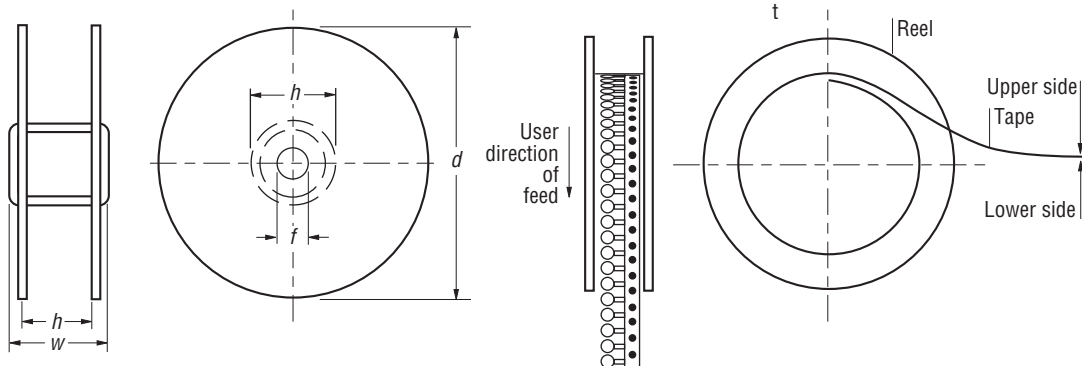

Specifications are subject to change without notice. The device characteristics and parameters in this data sheet can and do vary in different applications and actual device performance may vary over time. Users should verify actual device performance in their specific applications.