



Features

- Radial Leaded Devices
- Cured, flame retardant epoxy polymer insulating material meets UL 94V-0 requirements
- RoHS compliant* and halogen free**
- Agency recognition: 

Applications

- Almost anywhere there is a low voltage power supply and a load to be protected, including:
- Computers & peripherals
 - General electronics
 - Automotive applications

MF-R Series - PTC Resettable Fuses

Electrical Characteristics

| Model | V max. Volts | I max. Amps | Ihold | Itrip | Initial Resistance | | 1 Hour (R ₁) Post-Trip Resistance | Max. Time to Trip | | Tripped Power Dissipation |
|--------------|--------------|-------------|------------------|-------|--------------------|-------|---|-------------------|------------------|---------------------------|
| | | | Amperes at 23 °C | | Ohms at 23 °C | | Ohms at 23 °C | Amperes at 23 °C | Seconds at 23 °C | Watts at 23 °C |
| | | | Hold | Trip | Min. | Max. | Max. | | | Typ. |
| MF-R005 | 60 | 40 | 0.05 | 0.10 | 7.3 | 11.1 | 22.0 | 0.5 | 5.0 | 0.22 |
| MF-R010 | 60 | 40 | 0.10 | 0.20 | 2.50 | 4.50 | 7.50 | 0.5 | 4.0 | 0.38 |
| MF-R017 | 60 | 40 | 0.17 | 0.34 | 2.00 | 3.20 | 8.00 | 0.85 | 3.0 | 0.48 |
| MF-R020 | 60 | 40 | 0.20 | 0.40 | 1.50 | 2.84 | 4.40 | 1.0 | 2.2 | 0.40 |
| MF-R025 | 60 | 40 | 0.25 | 0.50 | 1.00 | 1.95 | 3.00 | 1.25 | 2.5 | 0.45 |
| MF-R030 | 60 | 40 | 0.30 | 0.60 | 0.76 | 1.36 | 2.10 | 1.5 | 3.0 | 0.50 |
| MF-R040 | 60 | 40 | 0.40 | 0.80 | 0.52 | 0.86 | 1.29 | 2.0 | 3.8 | 0.55 |
| MF-R050 | 60 | 40 | 0.50 | 1.00 | 0.41 | 0.77 | 1.17 | 2.5 | 4.0 | 0.75 |
| MF-R065 | 60 | 40 | 0.65 | 1.30 | 0.27 | 0.48 | 0.72 | 3.25 | 5.3 | 0.90 |
| MF-R075 | 60 | 40 | 0.75 | 1.50 | 0.18 | 0.40 | 0.60 | 3.75 | 6.3 | 0.90 |
| MF-R090 | 60 | 40 | 0.90 | 1.80 | 0.14 | 0.31 | 0.47 | 4.5 | 7.2 | 1.00 |
| MF-R090-0-9 | 30 | 40 | 0.90 | 1.80 | 0.07 | 0.12 | 0.22 | 4.5 | 5.9 | 0.60 |
| MF-R110 | 30 | 40 | 1.10 | 2.20 | 0.10 | 0.18 | 0.27 | 5.5 | 6.6 | 0.70 |
| MF-R135 | 30 | 40 | 1.35 | 2.70 | 0.065 | 0.115 | 0.17 | 6.75 | 7.3 | 0.80 |
| MF-R160 | 30 | 40 | 1.60 | 3.20 | 0.055 | 0.105 | 0.15 | 8.0 | 8.0 | 0.90 |
| MF-R185 | 30 | 40 | 1.85 | 3.70 | 0.040 | 0.07 | 0.11 | 9.25 | 8.7 | 1.00 |
| MF-R250 | 30 | 40 | 2.50 | 5.00 | 0.025 | 0.048 | 0.07 | 12.5 | 10.3 | 1.20 |
| MF-R250-0-10 | 30 | 40 | 2.50 | 5.00 | 0.025 | 0.048 | 0.07 | 12.5 | 10.3 | 1.20 |
| MF-R300 | 30 | 40 | 3.00 | 6.00 | 0.020 | 0.05 | 0.08 | 15.0 | 10.8 | 2.00 |
| MF-R400 | 30 | 40 | 4.00 | 8.00 | 0.010 | 0.03 | 0.05 | 20.0 | 12.7 | 2.50 |
| MF-R500 | 30 | 40 | 5.00 | 10.00 | 0.010 | 0.03 | 0.05 | 25.0 | 14.5 | 3.00 |
| MF-R600 | 30 | 40 | 6.00 | 12.00 | 0.005 | 0.02 | 0.04 | 30.0 | 16.0 | 3.50 |
| MF-R700 | 30 | 40 | 7.00 | 14.00 | 0.005 | 0.02 | 0.03 | 35.0 | 17.5 | 3.80 |
| MF-R800 | 30 | 40 | 8.00 | 16.00 | 0.005 | 0.02 | 0.03 | 40.0 | 18.8 | 4.00 |
| MF-R900 | 30 | 40 | 9.00 | 18.00 | 0.005 | 0.01 | 0.02 | 40.0 | 20.0 | 4.20 |
| MF-R1100 | 16 | 100 | 11.00 | 22.00 | 0.003 | 0.01 | 0.014 | 40.0 | 20.0 | 4.50 |

Environmental Characteristics

| | | |
|-------------------------------------|------------------------------------|---------------------------------|
| Operating/Storage Temperature | -40 °C to +85 °C | |
| Maximum Device Surface Temperature | | |
| in Tripped State | 125 °C | |
| Passive Aging | +85 °C, 1000 hours | ±5 % typical resistance change |
| Humidity Aging | +85 °C, 85 % R.H. 1000 hours | ±5 % typical resistance change |
| Thermal Shock | -40 °C to +85 °C, 10 times | ±10 % typical resistance change |
| Solvent Resistance | MIL-STD-202, Method 215 | No change |
| Vibration | MIL-STD-883C, Method 2007.1, | No change |
| | Condition A | |
| Moisture Sensitivity Level | 1 | |
| ESD Classification (HBM) | 6 | |

Test Procedures And Requirements For Model MF-R Series

| Test | Test Conditions | Accept/Reject Criteria |
|-----------------------|--|---|
| Visual/Mech. | Verify dimensions and materials | Per MF physical description |
| Resistance | In still air @ 23 °C | R _{min} ≤ R ≤ R _{max} |
| Time to Trip | 5 times I _{hold} , V _{max} , 23 °C | T ≤ max. time to trip (seconds) |
| Hold Current | 30 min. at I _{hold} | No trip |
| Trip Cycle Life | V _{max} , I _{max} , 100 cycles | No arcing or burning |
| Trip Endurance | V _{max} , 48 hours | No arcing or burning |

UL File Number E174545
<http://www.ul.com/> Follow link to Online Certificates Directory, then enter UL File No. E174545, or [click here](#)

TÜV Certificate Certificate Number Available on Request, or [click here](#)

* RoHS Directive 2002/95/EC Jan. 27, 2003 including annex and RoHS Recast 2011/65/EU June 8, 2011.

** Bourns follows the prevailing definition of "halogen free" in the industry. Bourns considers a product to be "halogen free" if (a) the Bromine (Br) content is 900 ppm or less; (b) the Chlorine (Cl) content is 900 ppm or less; and (c) the total Bromine (Br) and Chlorine (Cl) content is 1500 ppm or less.

Specifications are subject to change without notice.

Users should verify actual device performance in their specific applications.

The products described herein and this document are subject to specific disclaimers as set forth on the last page of this document, and at www.bourns.com/legal/disclaimer.pdf.

Additional Features

- Bulk packaging, tape and reel and Ammo-Pak available on most models

MF-R Series - PTC Resettable Fuses

BOURNS®

Product Dimensions (see next page for outline drawing)

| Model | A Max. | B Max. | C | | D Min. | E Max. | Physical Characteristics | | |
|--------------|------------------------|------------------------|------------------------|-----------------------|-----------------------|-----------------------|--------------------------|-------------------------|----------|
| | | | Nom. | Tol. ± | | | Style | Lead Dia. | Material |
| MF-R005 | $\frac{8.0}{(0.315)}$ | $\frac{8.3}{(0.327)}$ | $\frac{5.1}{(0.201)}$ | $\frac{0.7}{(0.028)}$ | $\frac{7.6}{(0.299)}$ | $\frac{3.1}{(0.122)}$ | 4 | $\frac{0.405}{(0.016)}$ | Sn/NiCu |
| MF-R010 | $\frac{7.4}{(0.291)}$ | $\frac{12.7}{(0.5)}$ | $\frac{5.1}{(0.201)}$ | $\frac{0.7}{(0.028)}$ | $\frac{7.6}{(0.299)}$ | $\frac{3.1}{(0.122)}$ | 1 | $\frac{0.51}{(0.020)}$ | Sn/NiCu |
| MF-R017 | $\frac{7.4}{(0.291)}$ | $\frac{12.7}{(0.5)}$ | $\frac{5.1}{(0.201)}$ | $\frac{0.7}{(0.028)}$ | $\frac{7.6}{(0.299)}$ | $\frac{3.1}{(0.122)}$ | 1 | $\frac{0.51}{(0.020)}$ | Sn/CuFe |
| MF-R020 | $\frac{7.4}{(0.291)}$ | $\frac{12.7}{(0.5)}$ | $\frac{5.1}{(0.201)}$ | $\frac{0.7}{(0.028)}$ | $\frac{7.6}{(0.299)}$ | $\frac{3.1}{(0.122)}$ | 1 | $\frac{0.51}{(0.020)}$ | Sn/CuFe |
| MF-R025 | $\frac{7.4}{(0.291)}$ | $\frac{12.7}{(0.5)}$ | $\frac{5.1}{(0.201)}$ | $\frac{0.7}{(0.028)}$ | $\frac{7.6}{(0.299)}$ | $\frac{3.1}{(0.122)}$ | 1 | $\frac{0.51}{(0.020)}$ | Sn/CuFe |
| MF-R030 | $\frac{7.4}{(0.291)}$ | $\frac{13.4}{(0.528)}$ | $\frac{5.1}{(0.201)}$ | $\frac{0.7}{(0.028)}$ | $\frac{7.6}{(0.299)}$ | $\frac{3.1}{(0.122)}$ | 1 | $\frac{0.51}{(0.020)}$ | Sn/CuFe |
| MF-R040 | $\frac{7.4}{(0.291)}$ | $\frac{13.7}{(0.539)}$ | $\frac{5.1}{(0.201)}$ | $\frac{0.7}{(0.028)}$ | $\frac{7.6}{(0.299)}$ | $\frac{3.1}{(0.122)}$ | 1 | $\frac{0.51}{(0.020)}$ | Sn/CuFe |
| MF-R050 | $\frac{7.9}{(0.311)}$ | $\frac{13.7}{(0.539)}$ | $\frac{5.1}{(0.201)}$ | $\frac{0.7}{(0.028)}$ | $\frac{7.6}{(0.299)}$ | $\frac{3.1}{(0.122)}$ | 1 | $\frac{0.51}{(0.020)}$ | Sn/Cu |
| MF-R065 | $\frac{9.7}{(0.382)}$ | $\frac{15.2}{(0.598)}$ | $\frac{5.1}{(0.201)}$ | $\frac{0.7}{(0.028)}$ | $\frac{7.6}{(0.299)}$ | $\frac{3.1}{(0.122)}$ | 1 | $\frac{0.51}{(0.020)}$ | Sn/Cu |
| MF-R075 | $\frac{10.4}{(0.409)}$ | $\frac{16.0}{(0.630)}$ | $\frac{5.1}{(0.201)}$ | $\frac{0.7}{(0.028)}$ | $\frac{7.6}{(0.299)}$ | $\frac{3.1}{(0.122)}$ | 1 | $\frac{0.51}{(0.020)}$ | Sn/Cu |
| MF-R090 | $\frac{11.7}{(0.461)}$ | $\frac{16.7}{(0.657)}$ | $\frac{5.1}{(0.201)}$ | $\frac{0.7}{(0.028)}$ | $\frac{7.6}{(0.299)}$ | $\frac{3.1}{(0.122)}$ | 1 | $\frac{0.51}{(0.020)}$ | Sn/Cu |
| MF-R090-0-9 | $\frac{7.4}{(0.291)}$ | $\frac{12.2}{(0.480)}$ | $\frac{5.1}{(0.201)}$ | $\frac{0.7}{(0.028)}$ | $\frac{7.6}{(0.299)}$ | $\frac{3.0}{(0.118)}$ | 3 | $\frac{0.51}{(0.020)}$ | Sn/CuFe |
| MF-R110 | $\frac{8.9}{(0.350)}$ | $\frac{14.0}{(0.551)}$ | $\frac{5.1}{(0.201)}$ | $\frac{0.7}{(0.028)}$ | $\frac{7.6}{(0.299)}$ | $\frac{3.0}{(0.118)}$ | 1 | $\frac{0.51}{(0.020)}$ | Sn/Cu |
| MF-R135 | $\frac{8.9}{(0.350)}$ | $\frac{18.9}{(0.744)}$ | $\frac{5.1}{(0.201)}$ | $\frac{0.7}{(0.028)}$ | $\frac{7.6}{(0.299)}$ | $\frac{3.0}{(0.118)}$ | 1 | $\frac{0.51}{(0.020)}$ | Sn/Cu |
| MF-R160 | $\frac{10.2}{(0.402)}$ | $\frac{16.8}{(0.661)}$ | $\frac{5.1}{(0.201)}$ | $\frac{0.7}{(0.028)}$ | $\frac{7.6}{(0.299)}$ | $\frac{3.0}{(0.118)}$ | 1 | $\frac{0.51}{(0.020)}$ | Sn/Cu |
| MF-R185 | $\frac{12.0}{(0.472)}$ | $\frac{18.4}{(0.724)}$ | $\frac{5.1}{(0.201)}$ | $\frac{0.7}{(0.028)}$ | $\frac{7.6}{(0.299)}$ | $\frac{3.0}{(0.118)}$ | 1 | $\frac{0.51}{(0.020)}$ | Sn/Cu |
| MF-R250 | $\frac{12.0}{(0.472)}$ | $\frac{18.3}{(0.720)}$ | $\frac{5.1}{(0.201)}$ | $\frac{0.7}{(0.028)}$ | $\frac{7.6}{(0.299)}$ | $\frac{3.0}{(0.118)}$ | 2 | $\frac{0.81}{(0.032)}$ | Sn/Cu |
| MF-R250-0-10 | $\frac{12.0}{(0.472)}$ | $\frac{18.3}{(0.720)}$ | $\frac{5.1}{(0.201)}$ | $\frac{0.7}{(0.028)}$ | $\frac{7.6}{(0.299)}$ | $\frac{3.0}{(0.118)}$ | 3 | $\frac{0.51}{(0.020)}$ | Sn/CuFe |
| MF-R300 | $\frac{12.0}{(0.472)}$ | $\frac{18.3}{(0.720)}$ | $\frac{5.1}{(0.201)}$ | $\frac{0.7}{(0.028)}$ | $\frac{7.6}{(0.299)}$ | $\frac{3.0}{(0.118)}$ | 2 | $\frac{0.81}{(0.032)}$ | Sn/Cu |
| MF-R400 | $\frac{14.4}{(0.567)}$ | $\frac{24.8}{(0.976)}$ | $\frac{5.1}{(0.201)}$ | $\frac{0.7}{(0.028)}$ | $\frac{7.6}{(0.299)}$ | $\frac{3.0}{(0.118)}$ | 2 | $\frac{0.81}{(0.032)}$ | Sn/Cu |
| MF-R500 | $\frac{17.4}{(0.685)}$ | $\frac{24.9}{(0.980)}$ | $\frac{10.2}{(0.402)}$ | $\frac{0.7}{(0.028)}$ | $\frac{7.6}{(0.299)}$ | $\frac{3.0}{(0.118)}$ | 2 | $\frac{0.81}{(0.032)}$ | Sn/Cu |
| MF-R600 | $\frac{19.3}{(0.760)}$ | $\frac{31.9}{(1.256)}$ | $\frac{10.2}{(0.402)}$ | $\frac{0.7}{(0.028)}$ | $\frac{7.6}{(0.299)}$ | $\frac{3.0}{(0.118)}$ | 2 | $\frac{0.81}{(0.032)}$ | Sn/Cu |
| MF-R700 | $\frac{22.1}{(0.870)}$ | $\frac{29.8}{(1.173)}$ | $\frac{10.2}{(0.402)}$ | $\frac{0.7}{(0.028)}$ | $\frac{7.6}{(0.299)}$ | $\frac{3.0}{(0.118)}$ | 2 | $\frac{0.81}{(0.032)}$ | Sn/Cu |
| MF-R800 | $\frac{24.2}{(0.953)}$ | $\frac{32.9}{(1.295)}$ | $\frac{10.2}{(0.402)}$ | $\frac{0.7}{(0.028)}$ | $\frac{7.6}{(0.299)}$ | $\frac{3.0}{(0.118)}$ | 2 | $\frac{0.81}{(0.032)}$ | Sn/Cu |
| MF-R900 | $\frac{24.2}{(0.953)}$ | $\frac{32.9}{(1.295)}$ | $\frac{10.2}{(0.402)}$ | $\frac{0.7}{(0.028)}$ | $\frac{7.6}{(0.299)}$ | $\frac{3.0}{(0.118)}$ | 2 | $\frac{0.81}{(0.032)}$ | Sn/Cu |
| MF-R1100 | $\frac{24.2}{(0.953)}$ | $\frac{32.9}{(1.295)}$ | $\frac{10.2}{(0.402)}$ | $\frac{0.7}{(0.028)}$ | $\frac{7.6}{(0.299)}$ | $\frac{3.0}{(0.118)}$ | 2 | $\frac{0.81}{(0.032)}$ | Sn/Cu |

Packaging options:

BULK: All models = 500 pcs. per bag

TAPE & REEL: MF-R005-MF-R160 12.7 mm device pitch = 3000 pcs. per reel
 MF-R185-MF-R400 25.4 mm device pitch = 1500 pcs. per reel
 MF-R500-MF-R1100 25.4 mm device pitch = 1000 pcs. per reel

AMMO-PACK: MF-R005-MF-R160 12.7 mm device pitch = 2000 pcs. per pack
 MF-R185-MF-R400 25.4 mm device pitch = 1000 pcs. per pack
 MF-R500-MF-R1100 25.4 mm device pitch = 500 pcs. per pack

0.405 (26AWG)
 0.51 (24AWG)
 0.81 (20AWG)

DIMENSIONS: $\frac{\text{MM}}{\text{(INCHES)}}$

Specifications are subject to change without notice.

Users should verify actual device performance in their specific applications.

The products described herein and this document are subject to specific disclaimers as set forth on the last page of this document, and at www.bourns.com/legal/disclaimer.pdf.

MF-R Series - PTC Resettable Fuses

BOURNS®

Product Dimensions (see previous page for dimensions)

Style 1

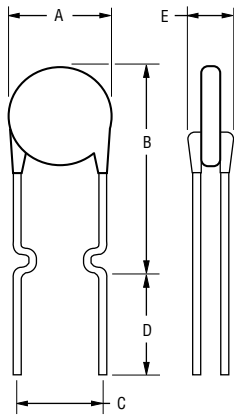

Style 2

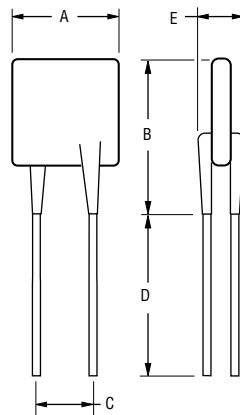

Style 3

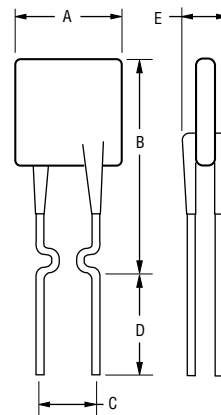

Style 4

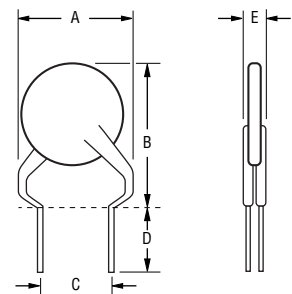

NOTE: Kinked lead option is available for board standoff. Contact factory for details.

NOTE: Also available with straight leads. Contact factory for details.

Thermal Derating Chart - I_{hold} / I_{trip} (Amps)

| Model | Ambient Operating Temperature | | | | | | | | |
|--------------|-------------------------------|-------------|-------------|-------------|-------------|-------------|-------------|-------------|-------------|
| | -40 °C | -20 °C | 0 °C | 23 °C | 40 °C | 50 °C | 60 °C | 70 °C | 85 °C |
| MF-R005 | 0.08 / 0.16 | 0.07 / 0.14 | 0.06 / 0.12 | 0.05 / 0.10 | 0.04 / 0.08 | 0.04 / 0.08 | 0.03 / 0.07 | 0.03 / 0.07 | 0.02 / 0.05 |
| MF-R010 | 0.16 / 0.32 | 0.14 / 0.28 | 0.12 / 0.24 | 0.10 / 0.20 | 0.08 / 0.16 | 0.07 / 0.14 | 0.06 / 0.12 | 0.05 / 0.10 | 0.04 / 0.08 |
| MF-R017 | 0.26 / 0.52 | 0.23 / 0.46 | 0.20 / 0.40 | 0.17 / 0.34 | 0.14 / 0.28 | 0.12 / 0.24 | 0.11 / 0.22 | 0.09 / 0.18 | 0.07 / 0.14 |
| MF-R020 | 0.31 / 0.62 | 0.27 / 0.54 | 0.24 / 0.48 | 0.20 / 0.40 | 0.16 / 0.32 | 0.14 / 0.28 | 0.13 / 0.26 | 0.11 / 0.22 | 0.08 / 0.16 |
| MF-R025 | 0.39 / 0.78 | 0.34 / 0.68 | 0.30 / 0.60 | 0.25 / 0.50 | 0.20 / 0.40 | 0.18 / 0.36 | 0.16 / 0.32 | 0.14 / 0.28 | 0.10 / 0.20 |
| MF-R030 | 0.47 / 0.94 | 0.41 / 0.82 | 0.36 / 0.72 | 0.30 / 0.60 | 0.24 / 0.48 | 0.22 / 0.44 | 0.19 / 0.38 | 0.16 / 0.32 | 0.12 / 0.24 |
| MF-R040 | 0.62 / 1.24 | 0.54 / 1.08 | 0.48 / 0.96 | 0.40 / 0.80 | 0.32 / 0.64 | 0.29 / 0.58 | 0.25 / 0.50 | 0.22 / 0.44 | 0.16 / 0.32 |
| MF-R050 | 0.78 / 1.56 | 0.68 / 1.36 | 0.60 / 1.20 | 0.50 / 1.00 | 0.41 / 0.82 | 0.36 / 0.72 | 0.32 / 0.64 | 0.27 / 0.54 | 0.20 / 0.40 |
| MF-R065 | 1.01 / 2.02 | 0.88 / 1.76 | 0.77 / 1.54 | 0.65 / 1.30 | 0.53 / 1.06 | 0.47 / 0.94 | 0.41 / 0.82 | 0.35 / 0.70 | 0.26 / 0.52 |
| MF-R075 | 1.16 / 2.32 | 1.02 / 2.04 | 0.89 / 1.78 | 0.75 / 1.50 | 0.61 / 1.22 | 0.54 / 1.08 | 0.47 / 0.94 | 0.41 / 0.82 | 0.30 / 0.60 |
| MF-R090 | 1.40 / 2.80 | 1.22 / 2.44 | 1.07 / 2.14 | 0.90 / 1.80 | 0.73 / 1.46 | 0.65 / 1.30 | 0.57 / 1.14 | 0.49 / 0.98 | 0.36 / 0.72 |
| MF-R090-0-9 | 1.40 / 2.80 | 1.22 / 2.44 | 1.07 / 2.14 | 0.90 / 1.80 | 0.73 / 1.46 | 0.65 / 1.30 | 0.57 / 1.14 | 0.49 / 0.98 | 0.36 / 0.72 |
| MF-R110 | 1.60 / 3.20 | 1.43 / 2.86 | 1.27 / 2.54 | 1.10 / 2.20 | 0.91 / 1.82 | 0.85 / 1.70 | 0.75 / 1.50 | 0.67 / 1.34 | 0.57 / 1.14 |
| MF-R135 | 1.96 / 3.92 | 1.76 / 3.52 | 1.55 / 3.10 | 1.35 / 2.70 | 1.12 / 2.24 | 1.04 / 2.08 | 0.92 / 1.84 | 0.82 / 1.64 | 0.70 / 1.40 |
| MF-R160 | 2.32 / 4.64 | 2.08 / 4.16 | 1.84 / 3.68 | 1.60 / 3.20 | 1.33 / 2.66 | 1.23 / 2.46 | 1.09 / 2.18 | 0.98 / 1.96 | 0.83 / 1.66 |
| MF-R185 | 2.68 / 5.36 | 2.41 / 4.82 | 2.13 / 4.26 | 1.85 / 3.70 | 1.54 / 3.08 | 1.42 / 2.84 | 1.26 / 2.52 | 1.13 / 2.26 | 0.96 / 1.92 |
| MF-R250 | 3.63 / 7.26 | 3.25 / 6.50 | 2.88 / 5.76 | 2.50 / 5.00 | 2.08 / 4.16 | 1.93 / 3.86 | 1.70 / 3.40 | 1.53 / 3.06 | 1.30 / 2.60 |
| MF-R250-0-10 | 3.63 / 7.26 | 3.25 / 6.50 | 2.88 / 5.76 | 2.50 / 5.00 | 2.08 / 4.16 | 1.93 / 3.86 | 1.70 / 3.40 | 1.53 / 3.06 | 1.30 / 2.60 |
| MF-R300 | 4.35 / 8.70 | 3.90 / 7.80 | 3.45 / 6.90 | 3.00 / 6.00 | 2.49 / 4.98 | 2.31 / 4.62 | 2.04 / 4.08 | 1.83 / 3.66 | 1.56 / 3.12 |
| MF-R400 | 5.80 / 11.6 | 5.20 / 10.4 | 4.60 / 9.20 | 4.00 / 8.00 | 3.32 / 6.64 | 3.08 / 6.16 | 2.72 / 5.44 | 2.44 / 4.88 | 2.08 / 4.16 |
| MF-R500 | 7.25 / 14.5 | 6.50 / 13.0 | 5.75 / 11.5 | 5.00 / 10.0 | 4.15 / 8.30 | 3.85 / 7.70 | 3.40 / 6.80 | 3.05 / 6.10 | 2.60 / 5.20 |
| MF-R600 | 8.70 / 17.4 | 7.80 / 15.6 | 6.90 / 13.8 | 6.00 / 12.0 | 4.98 / 9.96 | 4.62 / 9.24 | 4.08 / 8.16 | 3.66 / 7.32 | 3.12 / 6.24 |
| MF-R700 | 10.1 / 20.3 | 9.10 / 18.2 | 8.05 / 16.1 | 7.00 / 14.0 | 5.81 / 11.6 | 5.39 / 10.7 | 4.76 / 9.52 | 4.27 / 9.44 | 3.64 / 7.28 |
| MF-R800 | 11.6 / 23.2 | 10.4 / 20.8 | 9.20 / 18.4 | 8.00 / 16.0 | 6.64 / 13.2 | 6.16 / 12.3 | 5.44 / 10.8 | 4.88 / 9.76 | 4.16 / 8.32 |
| MF-R900 | 13.0 / 26.1 | 11.7 / 23.4 | 10.3 / 20.7 | 9.00 / 18.0 | 7.47 / 14.9 | 6.93 / 12.7 | 6.12 / 12.2 | 5.49 / 10.9 | 4.68 / 9.36 |
| MF-R1100 | 16.1 / 32.0 | 14.6 / 29.2 | 13.1 / 26.2 | 11.0 / 22.1 | 9.40 / 18.4 | 8.80 / 17.6 | 7.80 / 15.6 | 6.90 / 13.8 | 5.20 / 10.4 |

Specifications are subject to change without notice.

Users should verify actual device performance in their specific applications.

The products described herein and this document are subject to specific disclaimers as set forth on the last page of this document, and at www.bourns.com/legal/disclaimer.pdf.

MF-R Series - PTC Resettable Fuses

BOURNS®

Typical Time to Trip at 23 °C

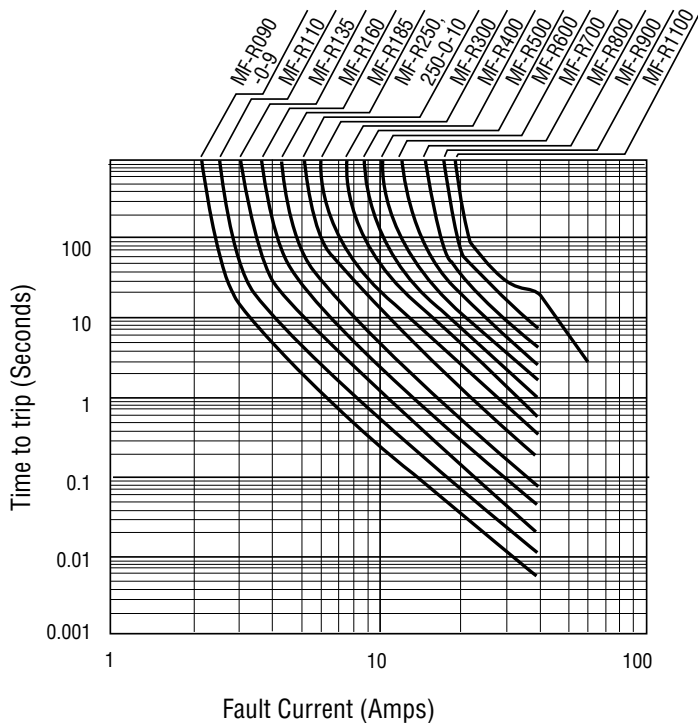
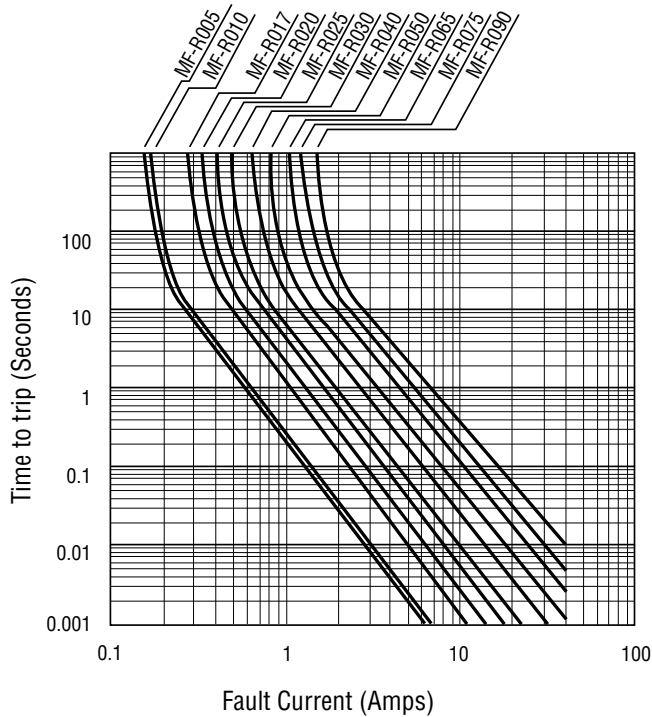

How to Order

MF - R 110 - 0 - 99

Multifuse®
 Product Designator _____
 Series _____
 R = Radial Leaded Component
 Hold Current, I_{hold} _____
 005-1100 (0.05 Amps - 11.0 Amps)
 Packaging Options _____
 - ____ = Bulk Packaging without part number suffix option
 - 0-99 = Bulk Packaging with part number suffix option
 - 2 = Tape and Reel without part number suffix option*
 - 2-99 = Tape and Reel with part number suffix option*
 - AP = Ammo-Pak*
 - 0-14 = Kinked leads where straight leads are standard
 - 0-17 = Straight leads where kinked leads are standard
 Part Number Suffix Option _____
 - 99 = RoHS Compliance
 As of date code April 1, 2005 all MF-R models are RoHS compliant. The suffix “-99” can be used if a new part number is required to reference the RoHS compliance, **but including the “-99” suffix option is not recommended for new designs.**

*Packaged per EIA486-B

Typical Part Marking: MF-R005 - R025

Represents total content. Layout may vary.

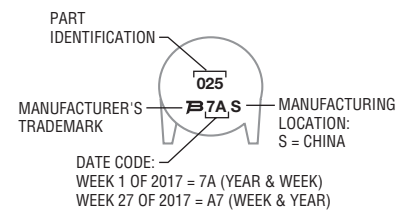

Typical Part Marking: MF-R030 - R1100

Represents total content. Layout may vary.

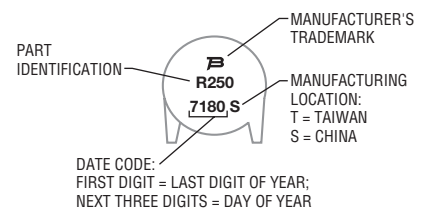

MF-R SERIES, REV. AH, 11/17

Specifications are subject to change without notice.

Users should verify actual device performance in their specific applications.

The products described herein and this document are subject to specific disclaimers as set forth on the last page of this document, and at www.bourns.com/legal/disclaimer.pdf.

MF-R, MF-R/90, MF-R/600, & MF-RX, & MF-RX/72 Series Tape and Reel Specifications

BOURNS®

Devices taped using EIA468-B/IEC286-2 standards. See table below and Figures 1 and 2 for details.

| Dimension Description | IEC Mark | EIA Mark | Dimensions | |
|---|------------|------------|------------------------|------------------------------------|
| | | | Dimensions | Tolerance |
| Carrier tape width | W | W | $\frac{18}{(.709)}$ | $\frac{-0.5/+1.0}{(-0.02/+0.039)}$ |
| Hold down tape width | W_0 | W_4 | $\frac{11}{(.433)}$ | min. |
| Hold down tape | | | No protrusion | |
| Top distance between tape edges | W_2 | W_6 | $\frac{3}{(.118)}$ | max. |
| Sprocket hole position | W_1 | W_5 | $\frac{9}{(.354)}$ | $\frac{-0.5/+0.75}{(-0.02/+0.03)}$ |
| Sprocket hole diameter | D_0 | D_0 | $\frac{4}{(.157)}$ | $\frac{\pm 0.2}{(\pm .0078)}$ |
| Abscissa to plane (straight lead) | H | H | $\frac{18.5}{(.728)}$ | $\frac{\pm 3.0}{(\pm .118)}$ |
| Abscissa to plane (kinked lead) | H_0 | H_0 | $\frac{16}{(.63)}$ | $\frac{\pm 0.5}{(\pm .02)}$ |
| Abscissa to top (straight lead) | H_1 | H_1 | $\frac{38.0}{(1.496)}$ | max. |
| Abscissa to top (kinked lead) | H_1 | H_1 | $\frac{32.2}{(1.268)}$ | max. |
| Overall width w/lead protrusion (straight lead) | | C_1 | $\frac{55.0}{(2.165)}$ | max. |
| Overall width w/lead protrusion (kinked lead) | | C_1 | $\frac{43.2}{(1.7)}$ | max. |
| Overall width w/o lead protrusion (straight lead) | | C_2 | $\frac{54.0}{(2.126)}$ | max. |
| Overall width w/o lead protrusion (kinked lead) | | C_2 | $\frac{42.5}{(1.673)}$ | max. |
| Lead protrusion | l_1 | L_1 | $\frac{1.0}{(.039)}$ | max. |
| Protrusion of cutout | L | L | $\frac{11}{(.433)}$ | max. |
| Protrusion beyond hold-down tape | l_2 | l_2 | Not specified | |
| Sprocket hole pitch | P_0 | P_0 | $\frac{12.7}{(0.5)}$ | $\frac{\pm 0.3}{(\pm .012)}$ |
| Pitch tolerance | | | 20 consecutive | $\frac{\pm 1}{(\pm .039)}$ |
| Device pitch: MF-R005–MF-R160, MF-R/90, MF-RX020/72–MF-RX030/72 | | | $\frac{12.7}{(0.5)}$ | $\frac{\pm 0.3}{(\pm .012)}$ |
| Device pitch: MF-R185–MF-R400, MF-R/600, MF-RX110–MF-RX375 MF-RX040/72–MF-RX375/72 | | | $\frac{25.4}{(1.0)}$ | $\frac{\pm 0.6}{(\pm .024)}$ |
| Tape thickness | t | t | $\frac{0.9}{(.035)}$ | max. |
| Tape thickness with splice: MF-R010–MF-R160, MF-RX110/72–MF-RX185/72 | | t_1 | $\frac{1.5}{(.059)}$ | max. |
| Tape thickness with splice: MF-R250–MF-R1100, MF-RX110–MF-RX375, MF-R/90, MF-RX250/72–MF-RX375/72 | | t_1 | $\frac{2.3}{(.091)}$ | max. |
| Splice sprocket hole alignment | | | 0 | $\frac{\pm 0.3}{(\pm .012)}$ |
| Body lateral deviation | Δ_h | Δ_h | 0 | $\frac{\pm 1.0}{(\pm .039)}$ |
| Body tape plane deviation | Δ_p | Δ_p | 0 | $\frac{\pm 1.3}{(\pm .051)}$ |

DIMENSIONS: $\frac{\text{MM}}{\text{(INCHES)}}$

Specifications are subject to change without notice.

Users should verify actual device performance in their specific applications.

The products described herein and this document are subject to specific disclaimers as set forth on the last page of this document, and at www.bourns.com/legal/disclaimer.pdf.

MF-R, MF-R/90, MF-R/600, MF-RX, & MF-RX/72 Series Tape and Reel Specifications

BOURNS®

| Dimension Description | IEC Mark | EIA Mark | Dimensions | |
|--|----------------------|----------------------|--|-------------------------------|
| | | | Dimensions | Tolerance |
| Lead spacing: MF-R, MF-R/90, MF-R/600, MF-RX, MF-RX/72 | <i>F</i> | <i>F</i> | $\frac{5.08}{(0.2)}$ | $\frac{\pm 0.2}{(\pm 0.008)}$ |
| Reel width | <i>w</i> | <i>W₂</i> | $\frac{56.0}{(2.205)}$ | max. |
| Reel diameter | <i>d</i> | <i>a</i> | $\frac{370.0}{(14.57)}$ | max. |
| Space between flanges less device | <i>W₁</i> | <i>h</i> | $\frac{4.75}{(.187)}$ | $\frac{\pm 3.25}{(\pm .128)}$ |
| Arbor hole diameter | <i>f</i> | <i>c</i> | $\frac{26.0}{(1.024)}$ | $\frac{\pm 12.0}{(\pm .472)}$ |
| Core diameter: MF-R, MF-RX, MF-R/90 | <i>h</i> | <i>n</i> | $\frac{80}{(3.15)}$ | max. |
| Core diameter: MF-R/600 | <i>h</i> | <i>n</i> | $\frac{91}{(3.58)}$ | max. |
| Box: MF-R, MF-RX, MF-R/90 | | | $\frac{62}{(2.44)}$ $\frac{355}{(14.0)}$ $\frac{345}{(13.6)}$ | nom. |
| Box: MF-R/600 | | | $\frac{64}{(2.52)}$ $\frac{372}{(14.6)}$ $\frac{362}{(14.25)}$ | max. |
| Consecutive missing places: MF-R, MF-RX, MF-R/90 | | | 3 | max. |
| Consecutive missing places: MF-R/600 | | | none | |
| Empty places per reel: MF-R, MF-RX, MF-R/90 | | | Not specified | |
| Empty places per reel: MF-R/600 | | | 0.1 % | |

**Taped Component Dimensions -
Figure 1**

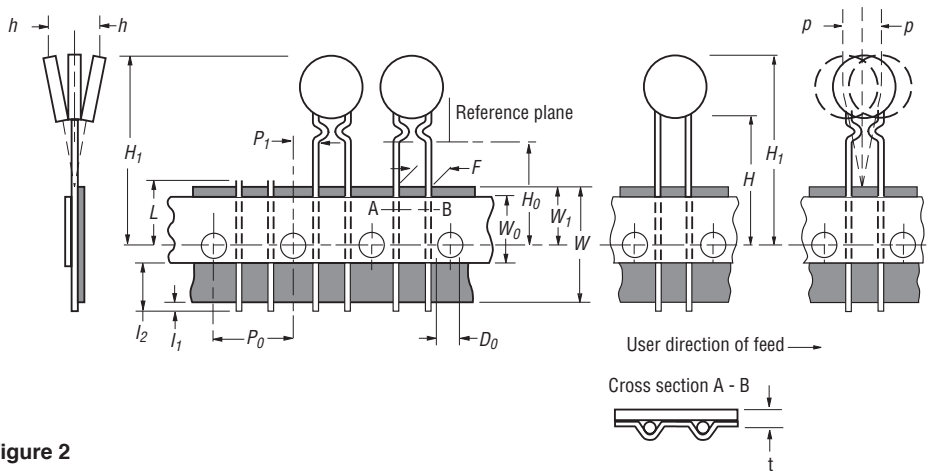

Reel Dimensions - Figure 2

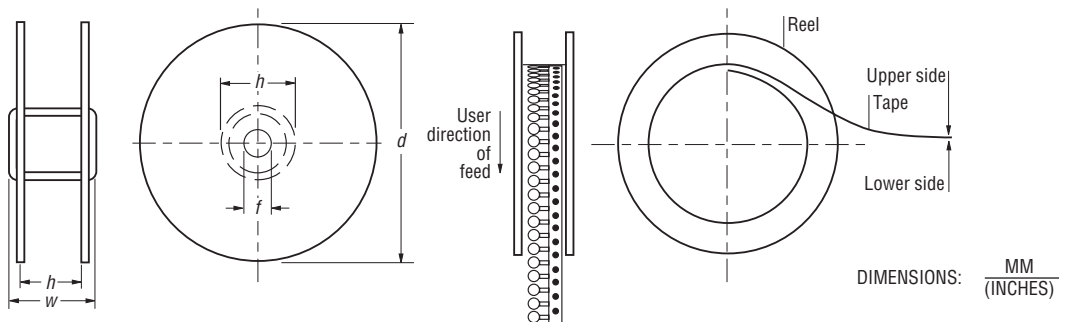

Specifications are subject to change without notice.
Users should verify actual device performance in their specific applications.
The products described herein and this document are subject to specific disclaimers as set forth on the last page of this document, and at www.bourns.com/legal/disclaimer.pdf.