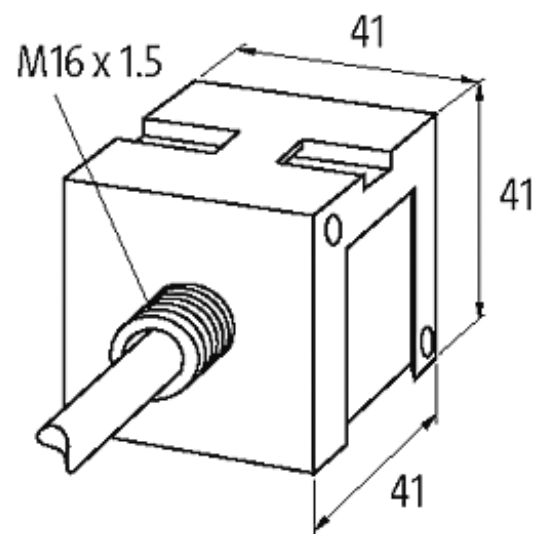

MOTOR SUPPRESSOR

RC, 3x400VAC/4kW

3 × 400 V AC
RC

Suppressors for other voltages, frequencies, and motor ratings available on request. Do not use RC motor suppressors with frequency inverters. For DIN-rail mounting use 2 × Art.-No. 20900 adapter feet

[Link to Product](#)**Illustration**

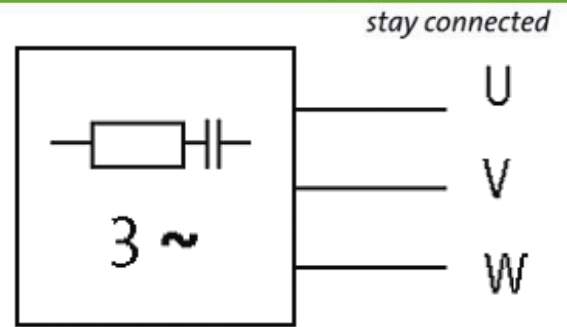

RC

Product may differ from Image

Technical Data

Frequency	50...60 Hz
Material	Flame retardant plastic acc. to (UL 94)
Potting compound	2-component epoxy

General data

Temperature range	-20...+60 °C
Connection	approx. 500 mm, PVC cable 3 × 0.75 mm ²
Dimensions H × W × D	41×41×41 mm

Commercial data

country of origin	CZ
customs tariff number	85363010
minimum order quantity	1