

MVP12, 4XM12, 4POLE, PLUGGABLE CABLE

5.0m PUR/PVC 4x0,34+3x0,75

4-way, 4-pole

PUR/PVC

5.0 m

with LED for digital PNP-signals 24 V DC

Further cable lengths on request. Plastic housings with good resistance against chemicals and oils. The resistance to aggressive media should be individually tested for your application. Further details on request.

[Link to Product](#)**Illustration**

M12 Females 4-pole

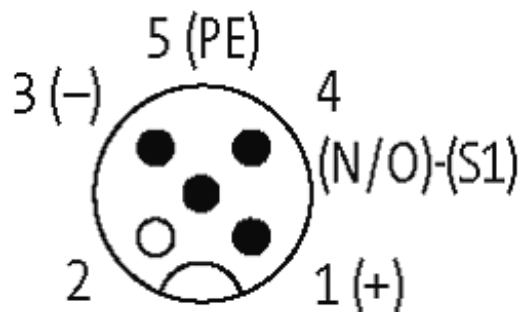

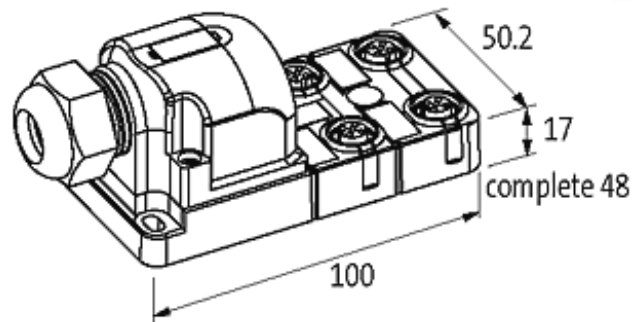

Product may differ from Image

Approvals



Technical Data

Housing	Plastic, flame retardant
Protection	IP67 inserted and tightened (EN 60529)
Operating voltage	24 V DC
Signal per port	1 - (31-32)
Operating current per contact	max. 4 A
Total current	max. 8 A
Locking of ports	Screw thread M12 × 1 mm

Cables

Cable number	333
No./diameter of wires	4×0.34 + 3×0.75 mm ²
Wire isolation	PVC
C-track properties	2 Mio.
Jacket Color	gray
Shore hardness outer jacket	85 ± 5A
Material (jacket)	PUR/PVC
Outer diameter	approx. 8.5 mm
Bend radius (fixed)	10 × outer Ø
Bend radius (moving)	12 × outer Ø
Temperature range (fixed)	-30...+80 °C
Temperature range (mobile)	-5...+80 °C

General data

Temperature range	-20...+80 °C
Dimensions H × W × D	100×50.2×17 mm

Contact layout

Contact 1	(+)
-----------	-----

Contact 3	(-)
Contact 4	(NO)/(S1)
Contact 5	(Earth)
LED display	LED (green): Power / LED (yellow): (S1)

Commercial data

country of origin	DE
customs tariff number	85369010
minimum order quantity	1