

CUBE67 I/O EXTENSION MODULE, VALVE-INTERFACE

16 digitale outputs for Norgren V20/22

Expansion module
DO16 - Valve (E) 0.5 m
Multipole plug (70 mA)
NORGREN - V20/22

Housing fully potted. For connection cables please see chapter "Connection Technology"

[Link to Product](#)

Illustration

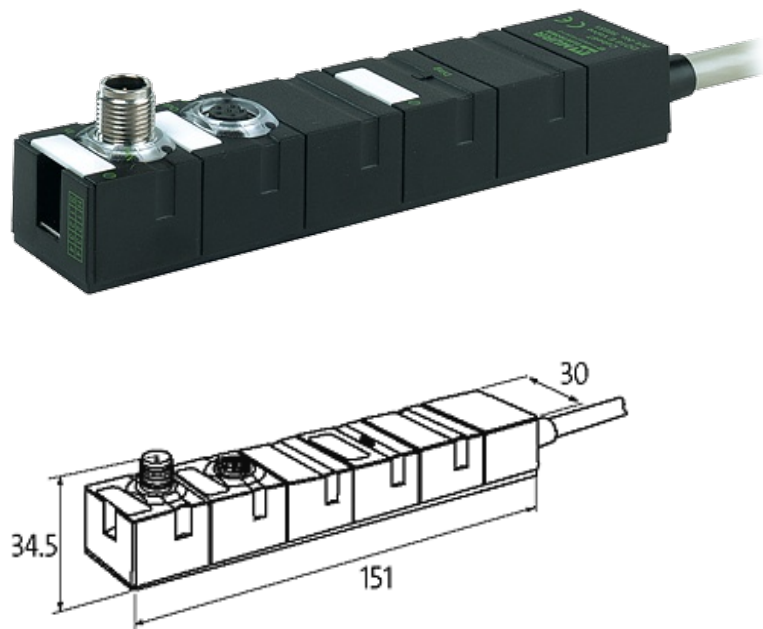

Product may differ from Image

Approvals



Internal communication

Current consumption	max. 50 mA
LED display	US: sensor supply and internal supply voltage (green: OK); UA: actuator supply (green: OK)

Connections

Fieldbus	via internal system connection
Sensor-system/actuator supply	via internal system connection (max. 2×4 A)

I/O ports Cable (0.5 m) / NORGREN - V20/22 (70 mA)

Cables

No./diameter of wires 18 × 0.25 mm²

Material (jacket) PVC

General data

Protection IP67

Mounting method 2-hole screw mounting

Temperature range 0...+55 °C (storage temperature -20...+75 °C)

Dimensions H × W × D 150×30×34.5 mm

Output

Actuator supply UA 24 V DC (EN 61131-2), via system connection (max. 4 A)

Switching current per output short-circuit and overload protected

Diagnostic

Communication status via LED

Diagnostic via LED per module

Diagnostic via BUS per module and channel

Monitoring - under voltage yes

Monitoring - no voltage yes

Short circuit and overload yes

Actuator warning per channel via BUS

Commercial data

country of origin DE

customs tariff number 85176200

minimum order quantity 1