

DO NOT SCALE DRAWING

REVISIONS				
ZONE	REV.	DESCRIPTION	DATE	APPROVED
	A	DRAWN	13-06-2013	

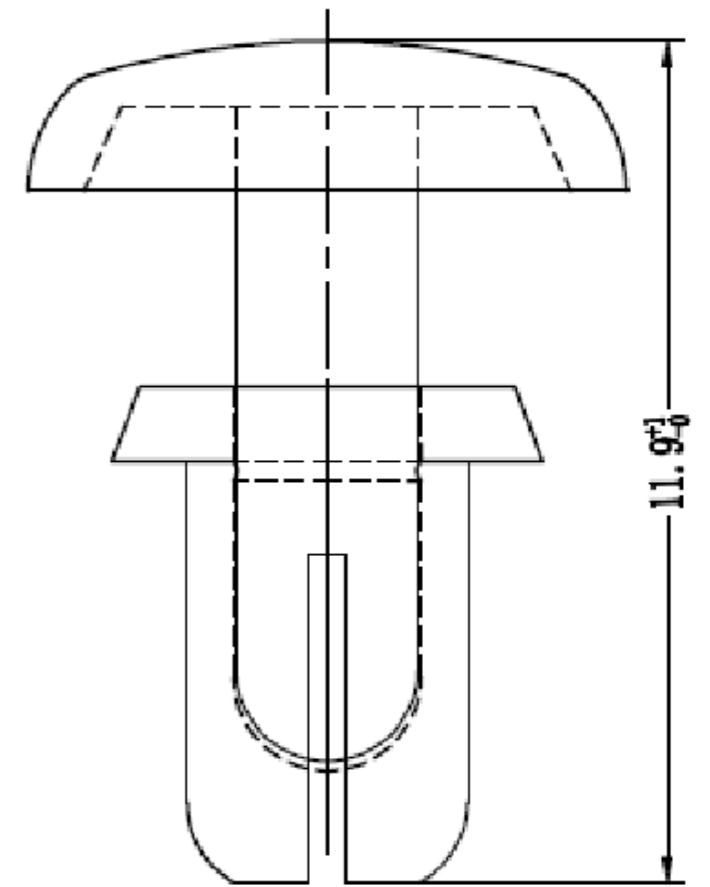
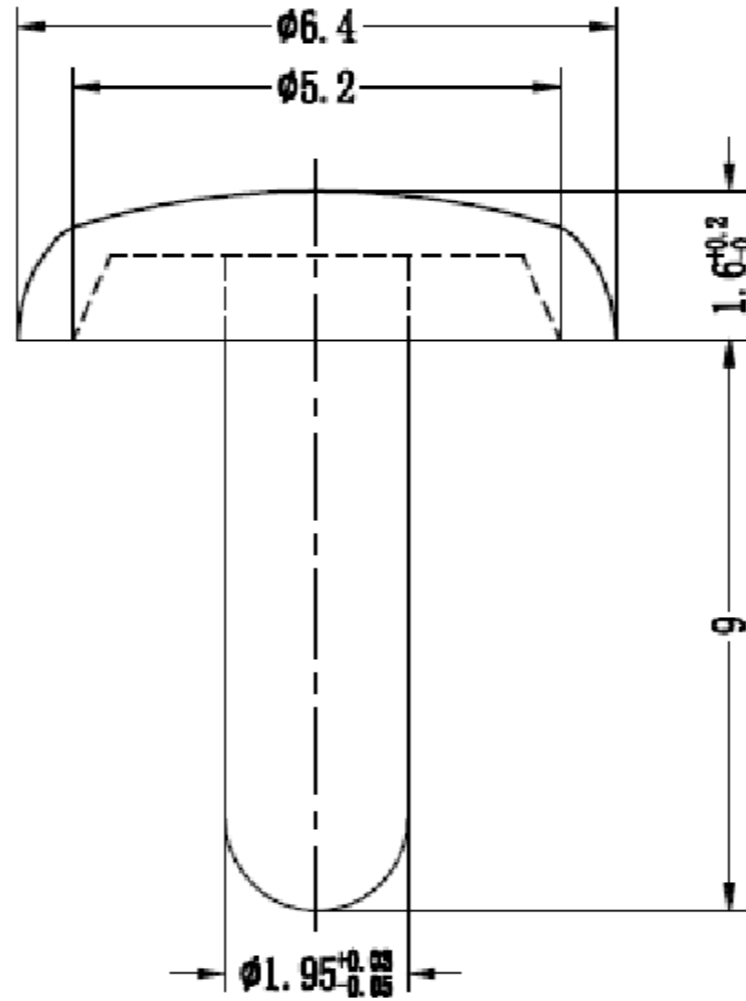
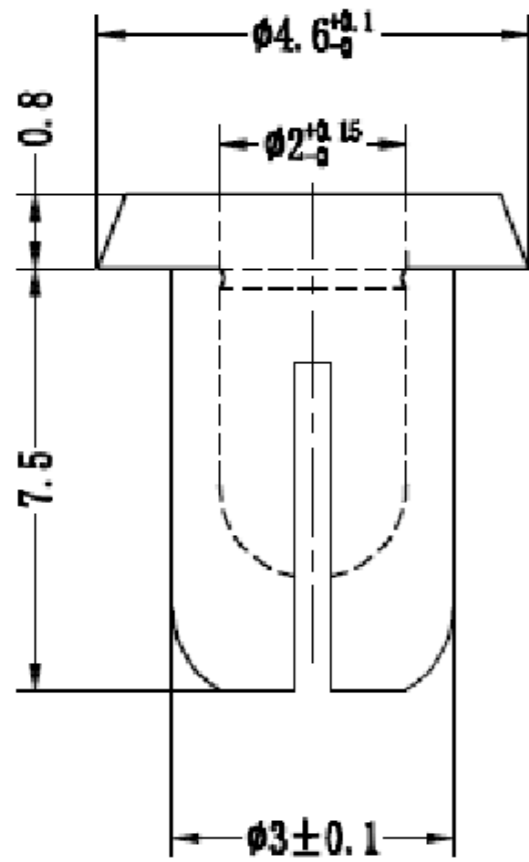

NOTES

Also available in flame retardant nylon (PA6 UL94V-0)



DESIGN RIGHT. TR FASTENINGS LTD, 2003  
UNDER NO CIRCUMSTANCES MUST THIS  
DRAWING BE COPIED OR DISCLOSED,  
WITHOUT FIRST OBTAINING WRITTEN  
AUTHORITY.

UNLESS OTHERWISE SPECIFIED:  
DIMENSIONS ARE IN MILLIMETERS.  
SURFACE FINISH:  
TOLERANCES:  
L ≤ 4 = ±0,1      4 < L ≤ 15 = ±0,2  
15 < L ≤ 50 = ±0,3      50 < L ≤ 100 = ±0,4

NAME	DATE
DRAWN DANIELE MONTALI	13/06/2013
CHK'D	
APPV'D	

MATERIAL  
PA6 UL94V-2  
ROHS compliant

HEAT TREATMENT  
N/A

FINISH  
Black or White

TITLE  
Snap Rivet

DWG NO.  
TRSR3075

A3