

MVP12, 4XM12, 5POLE, PLUGGABLE CABLE

10.0m PUR/PVC 8x0,34+5x0,75

4-way, 5-pole
 PUR/PVC
 potentially separated
 with LED for digital PNP-signals 24 V DC

Further cable lengths on request. Plastic housings with good resistance against chemicals and oils. The resistance to aggressive media should be individually tested for your application. Further details on request.

[Link to Product](#)

Illustration

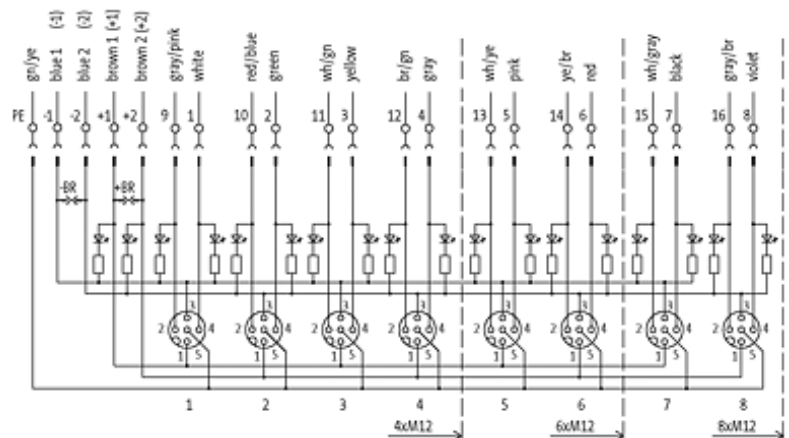

stay connected

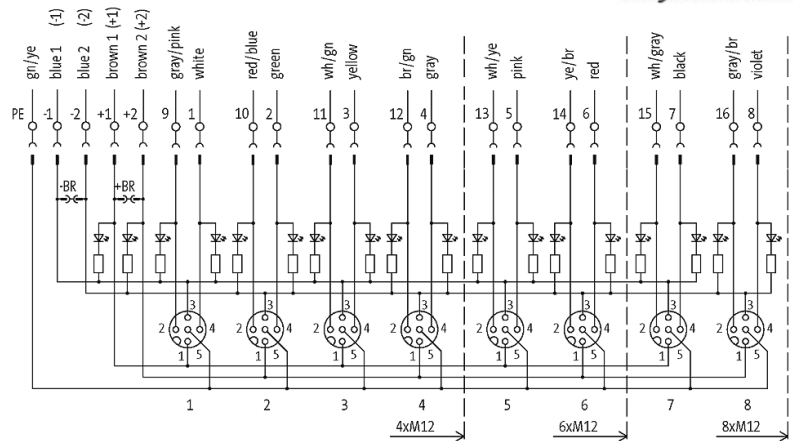

M12 Females 5-pole

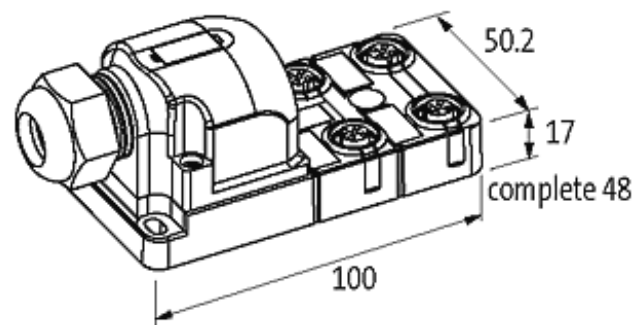
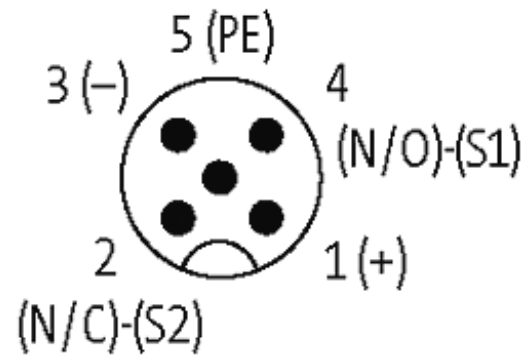

Product may differ from Image

Approvals



Technical Data

Housing	Plastic, flame retardant
Protection	IP67 inserted and tightened (EN 60529)
Operating voltage	24 V DC

The information in this brochure has been compiled with the utmost care.

Liability for the correctness completeness and topicality of the information is restricted to gross negligence. Version: 05/15

Operating current per contact	max. 4 A
Signal per port	2
Total current	max. 2 × 8 A
Locking of ports	Screw thread M12 × 1 mm

Cables

Cable number	374
No./diameter of wires	8×0.34 + 5×0.75 mm ²
Wire isolation	PVC
C-track properties	1.5 Mio.
Jacket Color	gray
Shore hardness outer jacket	85 ± 5A
Material (jacket)	PUR/PVC (UL/CSA)
Outer diameter	approx. 9.2 mm
Bend radius (fixed)	10 × outer Ø
Bend radius (moving)	12 × outer Ø
Temperature range (fixed)	-30...+80 °C
Temperature range (mobile)	-30...+80 °C

General data

Temperature range	-20...+80 °C
Dimensions H × W × D	100×50.2×17 mm

Contact layout

Contact 1	(+)
Contact 2	(NC)/(S2)
Contact 3	(-)
Contact 4	(NO)/(S1)
Contact 5	(Earth)
LED display	LED (green): Power / LED (yellow): (S1/S2)

Commercial data

country of origin	CZ
customs tariff number	85444290
minimum order quantity	1