

M12 MALE 90° / M12 FEMALE 90° 8 POLE

PUR 8x0,25 GRAY, drag ch 5m

Male 90° to female 90°
M12 - M12, 8-pole

Plastic housings with good resistance against chemicals and oils. The resistance to aggressive media should be individually tested for your application. Further details on request. Further cable lengths on request.

[Link to Product](#)

Illustration

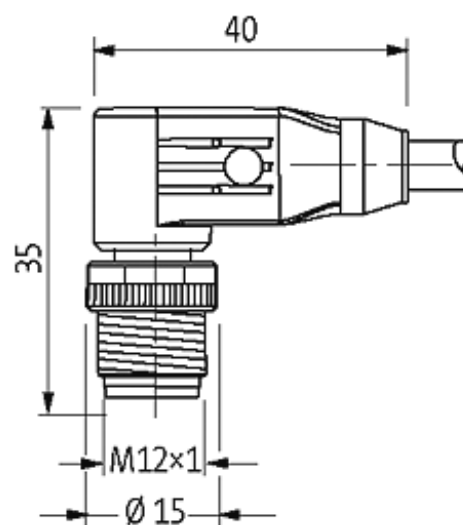
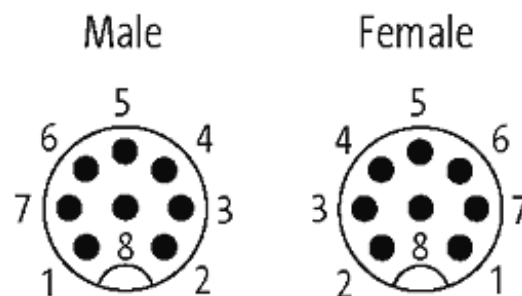
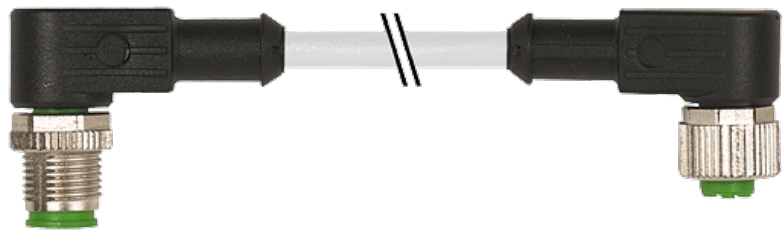

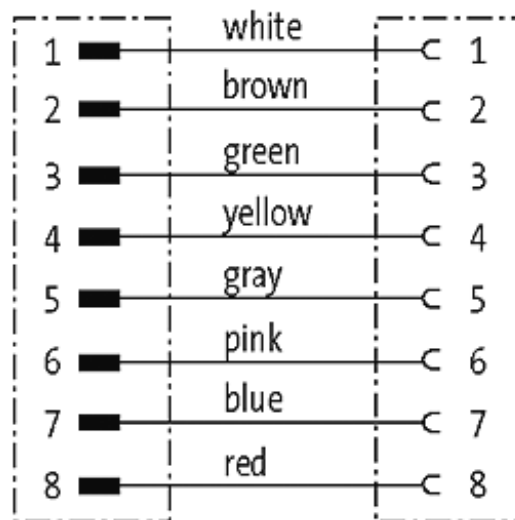
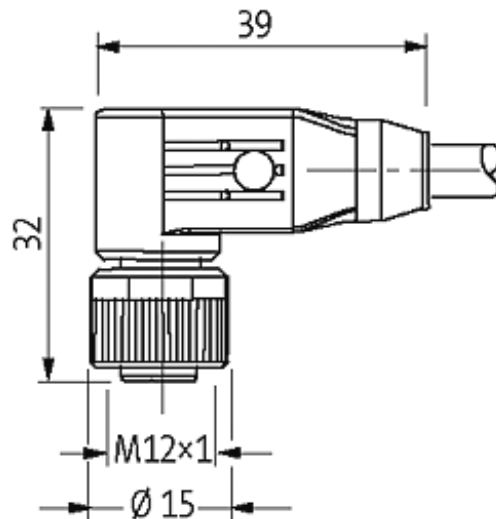

Product may differ from Image

Approvals



Form

48021

Technical Data

Protection	IP67 inserted and tightened (EN 60529)
Operating voltage	30 V AC/DC
Operating current per contact	max. 2 A
Locking of ports	Screw thread M12 × 1 mm (recommended torque 0.6 Nm) self-securing

Cables

Cable number	292
--------------	-----

No./diameter of wires	8 × 0.25 mm ²
Wire isolation	PP (wh, br, gn, ye, gr, pk, bl, rd)
C-track properties	2 Mio.
Jacket Color	gray
Shore hardness outer jacket	85 ± 5A
Material (jacket)	PUR
Outer diameter	approx. 6.0 mm
Bend radius (fixed)	10 × outer Ø
Bend radius (moving)	15 × outer Ø
Temperature range (fixed)	-40...+80 °C
Temperature range (mobile)	-20...+80 °C

Commercial data

country of origin	DE
customs tariff number	85444290
minimum order quantity	1