

# PC SCREW TERMINALS

These easy-to-mount, multipurpose screw type terminals are a practical, low-cost alternative to PC screw type edge connectors, barrier blocks, terminal boards and terminal strips. Steadfast and easy to install, will accommodate solid or stranded wire, crimp type terminals or lugs. Multi-placement of these low-profile terminals make them ideally suited for high density packaging. Supplied unassembled or with screw installed and captivated.

## PRINCIPAL FEATURES

- Low profile
- Stable, no-rock design with exclusive anti-rotational feature
- Easily mounts with four legs into pre-drilled or punched holes
- Accepts 14-22 AWG solid or stranded wire, crimp type terminals or lugs
- Ideally suited for high-density packaging
- Available in horizontal or vertical mounting
- Space-saving and time saving
- Easy accessibility for PC board testing
- Binding screw is positioned above board level to avoid wicking during wave soldering
- Terminals are made of Brass with Tin Plate
- Supplied with a combination drive 6-32 binding head screw

CAT. NO. COLOR SUFFIX  
Ex: XXXX -X

**COLOR SELECTION:**  
Select desired screw terminal and add color suffix to the screw terminal Cat. No.

HEAD COLOR	SUFFIX
RED	-2
BLACK	-3
WHITE	-4
BLUE	-5
GREEN	-6
YELLOW	-7
NICKEL	none

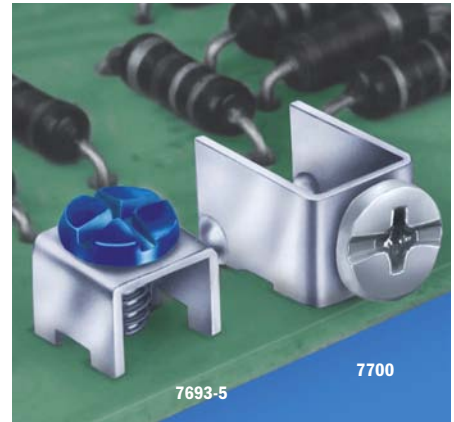

### SNAP-IN PC MOUNT

- Color coded screws available (add color screw suffix to Cat. No.)

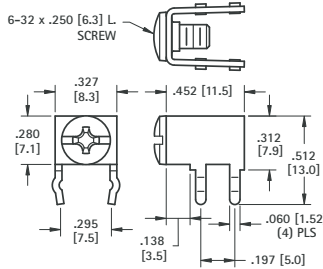

## HORIZONTAL TYPE

### SPECIFICATIONS

Rated: 15 Amps  
Terminal: .032 (.81) Brass, Matte Tin Plate  
Binding Head Screw: Brass, Nickel Plate

#### Mounting Detail

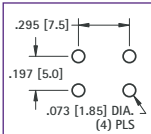

Color coded screws available (add color screw suffix to Cat. No.)

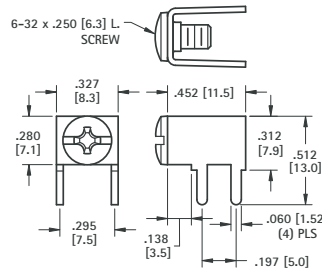

### PC MOUNT

- Color coded screws available (add color screw suffix to Cat. No.)

CAT. NO. 7779 (No Screw Supplied)

CAT. NO. 7690 (Screw Supplied Unassembled)

CAT. NO. 7692 (Screw Installed & Captivated)

CAT. NO. 7781 (No Screw Supplied)

CAT. NO. 8190 (Screw Supplied Unassembled)

CAT. NO. 7700 (Screw Installed & Captivated)



### SNAP-IN PC MOUNT

- Color coded screws available (add color screw suffix to Cat. No.)

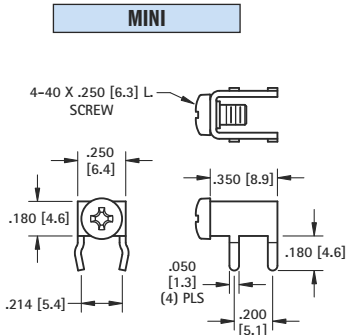

## SPECIFICATIONS

Rated: 15 Amps  
Terminal: .032 (.81) Brass, Matte Tin Plate  
Binding Head Screw: Brass, Nickel Plate

#### Mounting Detail

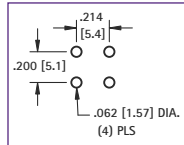

## 45°

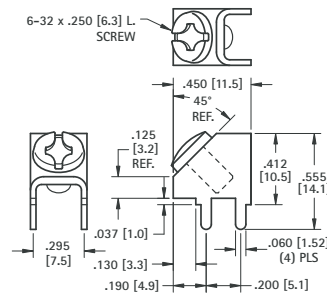

### PC MOUNT

- Color coded screws available (add color screw suffix to Cat. No.)

#### Mounting Detail

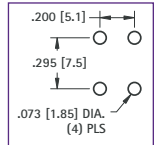

CAT. NO. 7774 (No Screw Supplied)

CAT. NO. 7773 (Screw Supplied Unassembled)

CAT. NO. 7783 (No Screw Supplied)

CAT. NO. 8189 (Screw Supplied Unassembled)

CAT. NO. 7702 (Screw Installed & Captivated)



### SNAP-IN PC MOUNT

- Color coded screws available (add color screw suffix to Cat. No.)

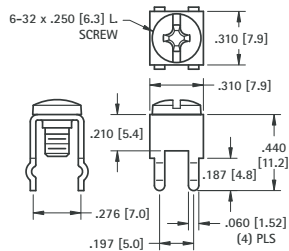

## VERTICAL TYPE

### SPECIFICATIONS

Rated: 15 Amps  
Terminal: .032 (.81) Brass, Matte Tin Plate  
Binding Head Screw: Brass, Nickel Plate

#### Mounting Detail

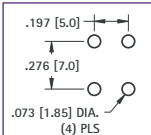

Color coded screws available (add color screw suffix to Cat. No.)

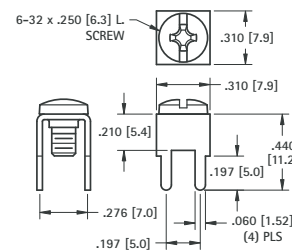

### PC MOUNT

- Color coded screws available (add color screw suffix to Cat. No.)

CAT. NO. 7780 (No Screw Supplied)

CAT. NO. 7691 (Screw Supplied Unassembled)

CAT. NO. 7693 (Screw Installed & Captivated)

CAT. NO. 7782 (No Screw Supplied)

CAT. NO. 8191 (Screw Supplied Unassembled)

CAT. NO. 7701 (Screw Installed & Captivated)