

M12 MALE 90° / M12 FEMALE 90° LED

PUR 4X0.34 black UL/CSA, drag ch 0.6m

Male 90° to female 90°

M12 - M12, 4-pole

3 × LED (PNP), (NPN) on request

Art.-No. 7005 - M12 Lite - (plastic hexagonal screw) on request

Plastic housings with good resistance against chemicals and oils. The resistance to aggressive media should be individually tested for your application. Further details on request. Further cable lengths on request.

[Link to Product](#)

Illustration

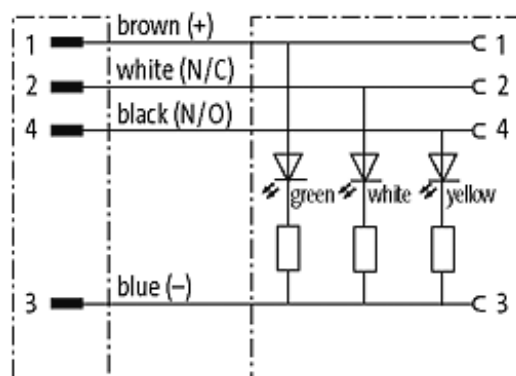

Male

Female

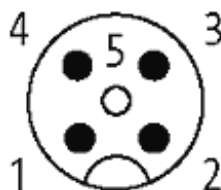

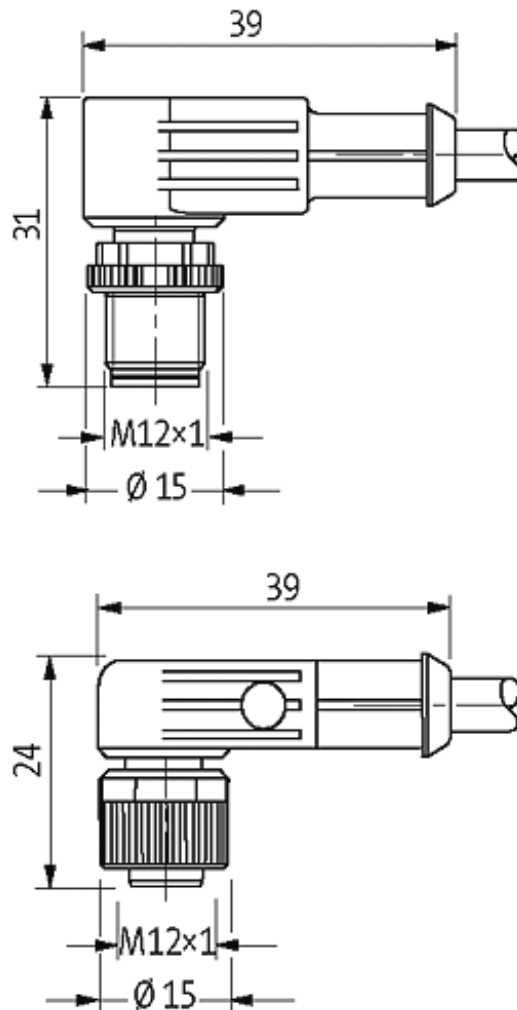

Product may differ from Image

Approvals



Form

40421

Technical Data

Protection	IP67 inserted and tightened (EN 60529)
Operating voltage	max. 30 V DC
Operating current per contact	max. 4 A
Locking of ports	Screw thread M12 × 1 mm (recommended torque 0.6 Nm) self-securing

Cables

Cable number	634
No./diameter of wires	4 × 0.34 mm ²
Wire isolation	PP (br, wh, bl, bk)

The information in this brochure has been compiled with the utmost care.

Liability for the correctness completeness and topicality of the information is restricted to gross negligence. Version: 05/15

C-track properties	5 Mio.
Torsion	2 Mio. \pm 180°/m
Jacket Color	black
Shore hardness outer jacket	90 \pm 5A
Material (jacket)	PUR (UL/CSA)
Outer diameter	approx. 4.7 mm
Bend radius (fixed)	5 \times outer \varnothing
Bend radius (moving)	10 \times outer \varnothing
Temperature range (fixed)	-40...+80 °C
Temperature range (mobile)	-25...+80 °C

General data

Temperature range	-25...+85 °C, depending on cable quality
-------------------	--

Commercial data

country of origin	DE
customs tariff number	85444290
minimum order quantity	1