



SURGE SUPPRESSOR, RC COUPLING, AC
400...600V, F. CONT. RELAYS A. MOTOR CONT. SZ
S00,

General technical data:

product brand name		SIRIUS
Product designation		surge suppressor
Size of contactor		S00
Design of the surge suppressor		with RC elements
Ambient temperature		
<ul style="list-style-type: none"> during storage 	°C	-40 ... +80
<ul style="list-style-type: none"> during operation 	°C	-25 ... +60

Control circuit/ Control:

Type of voltage of the control supply voltage		AC
Control supply voltage frequency		
<ul style="list-style-type: none"> 1 Rated value 	Hz	50
<ul style="list-style-type: none"> 2 Rated value 	Hz	60
Control supply voltage 1		
<ul style="list-style-type: none"> with AC 		
<ul style="list-style-type: none"> — at 50 Hz Initial rated value 	V	400
<ul style="list-style-type: none"> — at 50 Hz Final rated value 	V	600
<ul style="list-style-type: none"> — at 60 Hz Final rated value 	V	600
<ul style="list-style-type: none"> — at 60 Hz Initial rated value 	V	400





Installation/ mounting/ dimensions:

mounting position		any
Mounting type		clip-on
Width	mm	28
Height	mm	46

Depth	mm	9
-------	----	---

Certificates/ approvals:

Certificate of suitability CE / UL / CSA / CCC

General Product Approval	Declaration of Conformity	Test Certificates	Shipping Approval
 UL	 EAC	 EG-Konf.	Special Test Certificate  ABS  BUREAU VERITAS

Shipping Approval

 DNV	 GL	 LRS	 PRS	 RINA	 RMRS
--	---	--	--	---	---

other

[Confirmation](#)
[Environmental Confirmations](#)

VDE

Further information

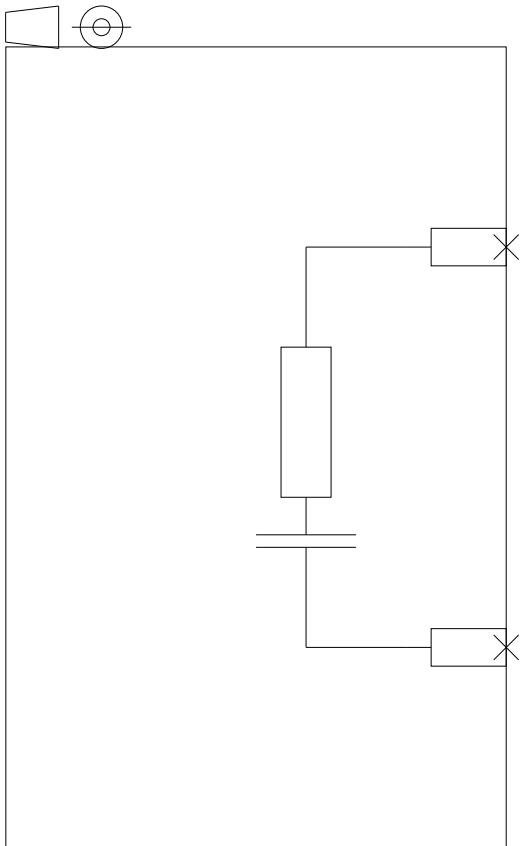
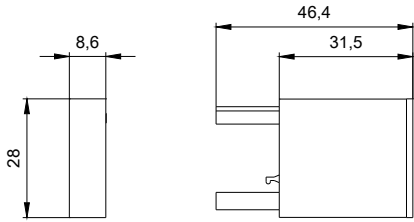
- Information- and Downloadcenter (Catalogs, Brochures,...)
<http://www.siemens.com/industrial-controls/catalogs>
- Industry Mall (Online ordering system)
<http://www.siemens.com/industrymall>
- Cax online generator
<http://support.automation.siemens.com/WW/CAXorder/default.aspx?lang=en&mlfb=3RT29161CF00>
- Service&Support (Manuals, Certificates, Characteristics, FAQs,...)
<http://support.automation.siemens.com/WW/view/en/3RT29161CF00/all>
- Image database (product images, 2D dimension drawings, 3D models, device circuit diagrams, EPLAN macros, ...)
<http://www.automation.siemens.com/bilddb/index.aspx?attID9=3RT29161CF00&lang=en>



last modified:

09.03.2015