

Vitreous Wirewound Resistors with Corrugated Ribbon



The GBS series, with completely welded construction, is the perfect choice for high continuous power dissipation up to 1000 W and is offered with an optional adjustable type. The UL 508 recognized GBS..UL1 series fulfill the requirements for power circuit and motor mounted apparatus components. The components of this series are well suited for harsh environments and exhibit a long lifetime. With their high pulse power capability, they are the ideal choice for inrush limiters. Typical applications include but are not limited to drive systems, power supplies, frequency inverters, AC filters, and snubber resistors. Particular requirements can be submitted to a Vishay Draloric application engineer specifying peak voltage, pulse shape, pulse duration, and environmental conditions for review.

FEATURES

- UL 508 and CSA C22.2 recognized available; file no. E499556
- Maximum Voltage to ground: 1000 V_{AC} / V_{DC}
- High power rating up to 1000 W
- Excellent pulse load capability
- Low ohmic values
- Adjustable type (E) available
- Corrugated ribbon construction aids rapid cooling
- Non-flammable and enhanced humidity protection
- Material categorization: for definitions of compliance please see www.vishay.com/doc?99912



RoHS
COMPLIANT
HALOGEN
FREE

APPLICATIONS

- Drive systems
- Inrush current limiter
- Capacitor charge / discharge
- Snubber resistor
- Brake resistor
- Filter resistor

TECHNICAL SPECIFICATION

TYPE	RATED DISSIPATION <i>P</i> ₄₀ WM50 WM110	RATED DISSIPATION <i>P</i> ₄₀ WM10	RESISTANCE RANGE ⁽¹⁾ TCR +650 ppm/K to +750 ppm/K WM10	RESISTANCE RANGE ⁽¹⁾ TCR -10 ppm/K to -80 ppm/K WM50	RESISTANCE RANGE ⁽¹⁾ TCR +100 ppm/K to +180 ppm/K WM110	RESISTANCE TOLERANCE
GBS 20/100 GBS 20/100 E	80 W 50 W	50 W	0.13 Ω to 0.51 Ω	0.56 Ω to 2.2 Ω	1.3 Ω to 6.2 Ω	± 5 %, ± 10 %
GBS 20/165 GBS 20/165 E	160 W 100 W	100 W	0.27 Ω to 1.0 Ω	1.1 Ω to 4.7 Ω	2.4 Ω to 12 Ω	
GBS 20/265 GBS 20/265 E	300 W 180 W	180 W	0.47 Ω to 1.8 Ω	2.0 Ω to 7.5 Ω	4.3 Ω to 22 Ω	
GBS 30/100 GBS 30/100 E	150 W 90 W	90 W	0.10 Ω to 0.43 Ω	0.47 Ω to 3.3 Ω	1.0 Ω to 8.2 Ω	
GBS 30/133 GBS 30/133 E	200 W 120 W	120 W	0.15 Ω to 0.62 Ω	0.68 Ω to 5.1 Ω	1.5 Ω to 12 Ω	
GBS 30/165 GBS 30/165 E	250 W 150 W	150 W	0.20 Ω to 0.91 Ω	1.0 Ω to 6.8 Ω	2.0 Ω to 16 Ω	
GBS 30/215 GBS 30/215 E	300 W 200 W	200 W	0.27 Ω to 1.1 Ω	1.2 Ω to 9.1 Ω	2.7 Ω to 24 Ω	
GBS 30/265 GBS 30/265 E	375 W 250 W	250 W	0.30 Ω to 1.3 Ω	1.5 Ω to 11 Ω	3.9 Ω to 27 Ω	
GBS 30/330 GBS 30/330 E	450 W 350 W	350 W	0.39 Ω to 1.8 Ω	2.0 Ω to 15 Ω	5.1 Ω to 36 Ω	
GBS 45/370 GBS 45/370 E	750 W 550 W	550 W	0.75 Ω to 3.0 Ω	3.3 Ω to 24 Ω	8.2 Ω to 56 Ω	
GBS 60/370 GBS 60/370 E	1000 W 700 W	700 W	0.91 Ω to 3.9 Ω	4.3 Ω to 33 Ω	10 Ω to 75 Ω	

Notes

- The operating temperature range for these resistors is from -55 °C up to 350 °C
- (1) Resistance values are to be selected for ± 10 % from the E12 series, and for ± 5 % from the E24 series



PACKAGING				
TYPE	PACKAGING CODE	QUANTITY	FORMAT	DIMENSION OF PACKAGE
All	LX	Variable	Bulk, separately packed with paper	Box size selection according to quantity and product size

PART NUMBER AND PRODUCT DESCRIPTION

Part Number: **GBS60AA13750KLX000**
GBS60AA01330KLXUL1

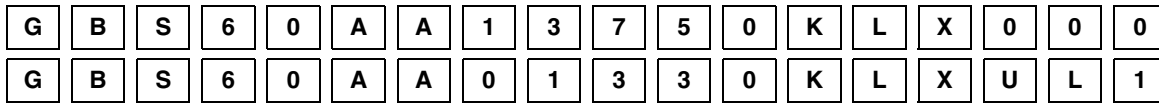

TYPE	VARIANT / TERMINAL	TCR / MATERIAL	RESISTANCE	TOLERANCE	PACKAGING	SPECIAL
GBS202S = GBS 20/100 GBS204L = GBS 20/165 GBS207D = GBS 20/265 GBS302S = GBS 30/100 GBS303P = GBS 30/133 GBS304L = GBS 30/165 GBS305Z = GBS 30/215 GBS307D = GBS 30/265 GBS3096 = GBS 30/330 GBS45AA = GBS 45/370 GBS60AA = GBS 60/370	0 = neutral 1 = E (adjustable)	1 = WM 50 -10 ppm/K to -80 ppm/K 3 = WM 110 +100 ppm/K to +180 ppm/K 4 = WM 10 +650 ppm/K to +750 ppm/K	2 digit value 1 digit multiplier MULTIPLIER 8 = *10 ⁻² 9 = *10 ⁻¹ 0 = *10 ⁰	J = ± 5 % K = ± 10 %	LX = loose pack without quantity	000 = standard 3 digit code = customized version UL1 = UL 508 / CSA C22.2 version

Product Description: **GBS60/370 E 110 75R 10 %**
GBS60/370 50 33R 10 % UL1000V

GBS60/370	E	110	75R	10 %	
GBS60/370		50	33R	10 %	UL1
TYPE	VARIANT / TERMINAL	TCR / MATERIAL	RESISTANCE	TOLERANCE	SPECIAL
GBS20/100 GBS20/165 GBS20/265 GBS30/100 GBS30/133 GBS30/165 GBS30/215 GBS30/265 GBS30/330 GBS45/370 GBS60/370	Neutral E (adjustable)	50 = WM 50 110 = WM 110 10 = WM 10	R10 = 0.1 Ω 75R = 75 Ω	± 5 % ± 10 %	UL1000V

Note

- The products can be ordered using either the PRODUCT DESCRIPTION or the PART NUMBER



DESCRIPTION

Vitreous wirewound resistors are best suited for the use in demanding environmental conditions. Their rugged design and durable coatings enable these resistors to withstand extreme environmental stress. The vitreous coating is designed for high stability and a long lifetime in humid environments. The coating is resistant to all cleaning chemicals commonly used in the electronic industry.

Production is strictly controlled and follows an extensive set of instructions established for reproducibility. The winding is done with specific materials on a specially developed fine ceramic body (Al_2O_3). The ceramic meets the highest requirements against mechanical resistance, thermal shocks, dielectric strength, and insulation resistance at high temperatures. With different corrugated ribbons and turn spacings, low ohmic values can be offered. With this construction, rapid cooling is also possible. The glaze is fired layer by layer, several times, at a high temperature ($> 600\text{ }^\circ\text{C}$). The resistors are marked with resistance, tolerance, and winding material.

The GBS series meets single lot / date code packaging requirements.

MATERIALS

Vishay acknowledges the following systems for the regulation of hazardous substances:

- IEC 62474, Material Declaration for Products of and for the Electrotechnical Industry, with the list of declarable substances given therein ⁽¹⁾
- The Global Automotive Declarable Substance List (GADSL) ⁽²⁾
- The REACH regulation (1907/2006/EC) and the related list of substances with very high concern (SVHC) ⁽³⁾ for its supply chain

The products do not contain any of the banned substances as per IEC 62474, GADSL, or the SVHC list, see www.vishay.com/how/leadfree.

Hence the products fully comply with the following directives:

- 2000/53/EC End-of-Life Vehicle Directive (ELV) and Annex II (ELV II)
- 2011/65/EU Restriction of the Use of Hazardous Substances Directive (RoHS) with amendment 2015/863/EU
- 2012/19/EU Waste Electrical and Electronic Equipment Directive (WEEE)

Vishay pursues the elimination of conflict minerals from its supply chain, see the Conflict Minerals Policy at www.vishay.com/doc?49037.

Notes

- ⁽¹⁾ The IEC 62474 list of declarable substances is maintained in a dedicated database, which is available at <http://std.iec.ch/iec62474>
- ⁽²⁾ The Global Automotive Declarable Substance List (GADSL) is maintained by the American Chemistry Council, and available at www.gadsl.org
- ⁽³⁾ The SVHC list is maintained by the European Chemical Agency (ECHA) and available at <http://echa.europa.eu/candidate-list-table>

ASSEMBLY

The resistors are fitted with lugs for soldering. The terminals of the resistors are completely lead (Pb)-free. The special tin plating used provides compatibility with lead (Pb)-free and lead-containing soldering processes.

Special lugs may be available on request, please inquire at ww1resistors@vishay.com.

3D-Models are available on request, please inquire at ww1resistors@vishay.com.

Different mounting accessories are available for fixing, see the datasheet: www.vishay.com/doc?21015.

The slider of the adjustable type should be only moved after removal of voltage and sufficient loosening of the screw.

APPLICATION INFORMATION

The power dissipation of the resistor generates a temperature rise with respect to the ambient. The permissible dissipation is derated for temperatures above $40\text{ }^\circ\text{C}$, as shown in the derating diagram, in order to avoid overheating of the resistor. The heat dissipated from the resistor may affect adjacent components, hence proper clearance will be required in order to avoid overheating.

All materials used are non-flammable and inorganic.

These resistors do not feature a limited lifetime when operated within the permissible limits. However, resistance value drift increasing over operating time may result in exceeding a limit acceptable to the specific application, thereby establishing a functional lifetime.

RELATED PRODUCTS

In lower continuous power applications and less demanding environmental conditions the cement coated alternative, like the ZBS series might be suitable, see the datasheet:

“Cemented Wirewound Resistors with Corrugated Ribbon”
www.vishay.com/doc?21011

For high ohmic values, there is the vitreous coated GWS series, see the datasheet:

“Vitreous Wirewound Resistors with Lugs”
www.vishay.com/doc?21003



DERATING

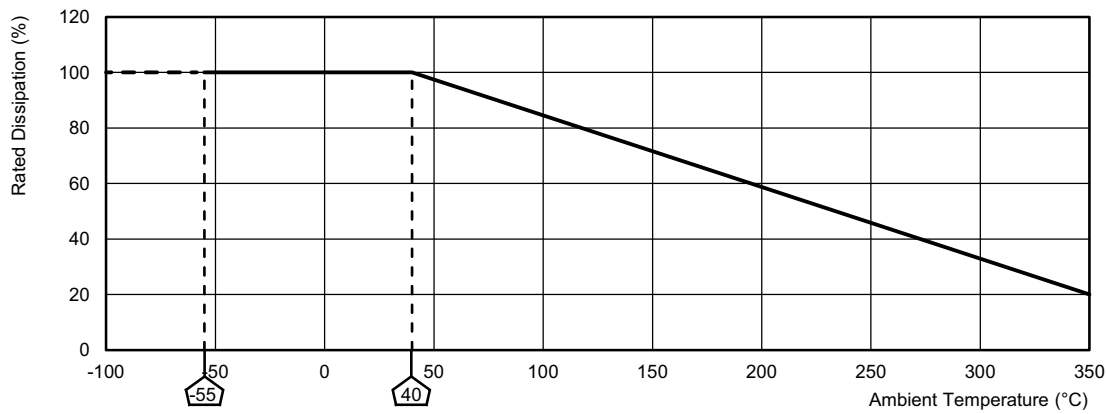

TEMPERATURE RISE

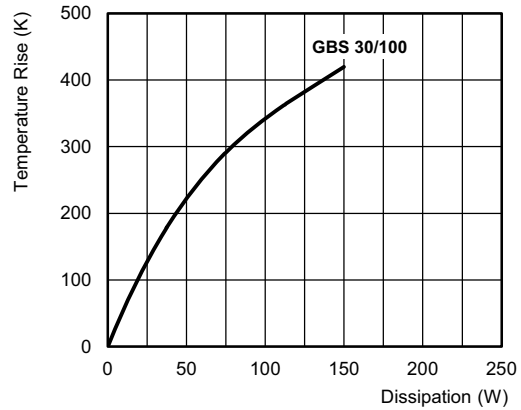
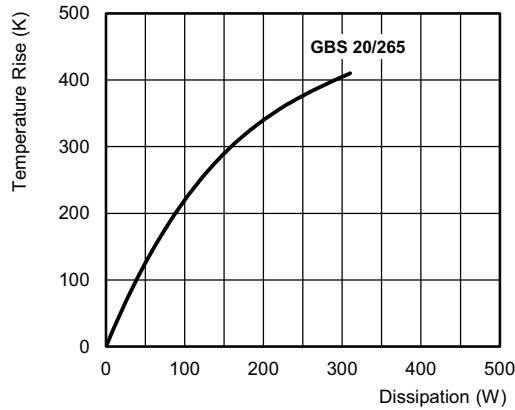
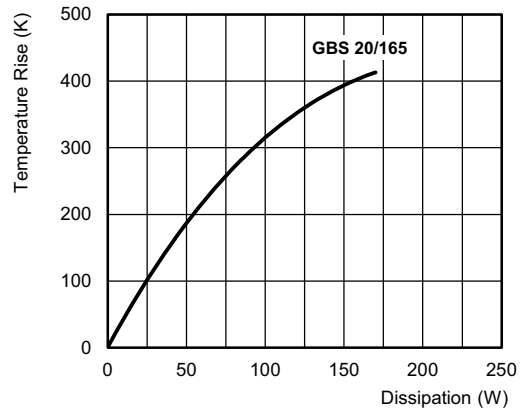
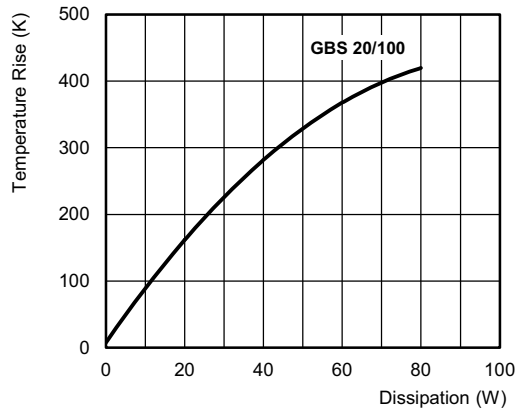



TEMPERATURE RISE

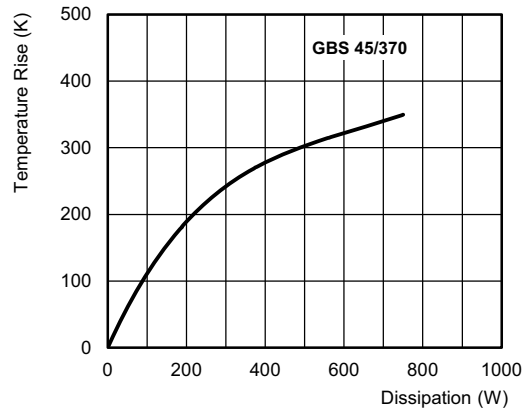
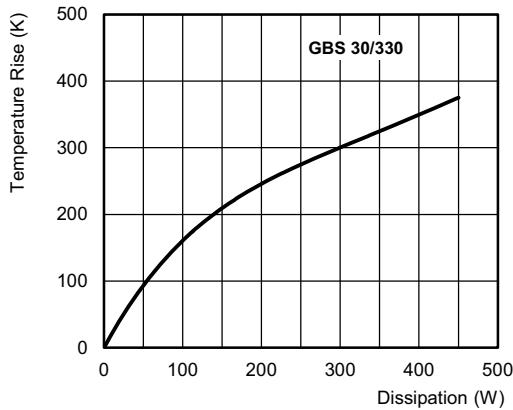
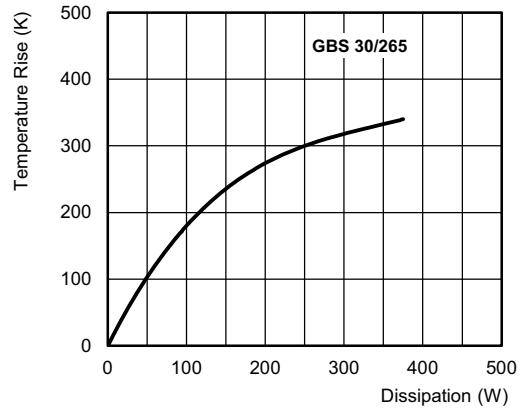
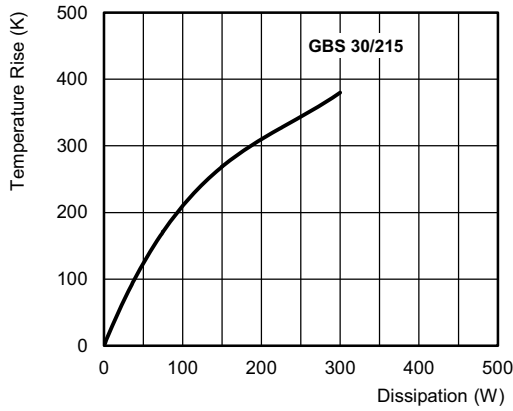
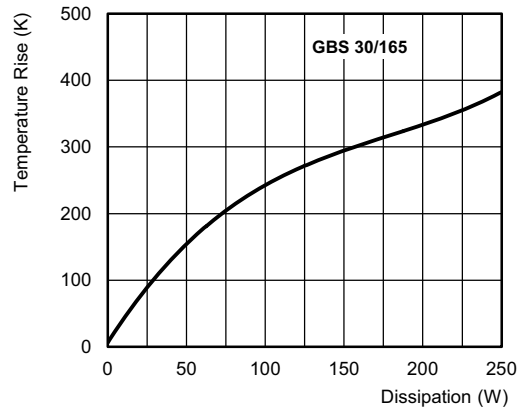
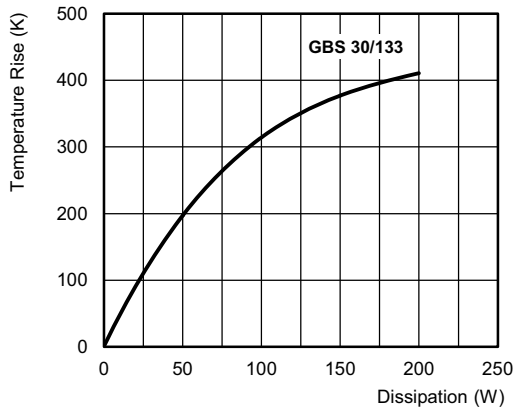

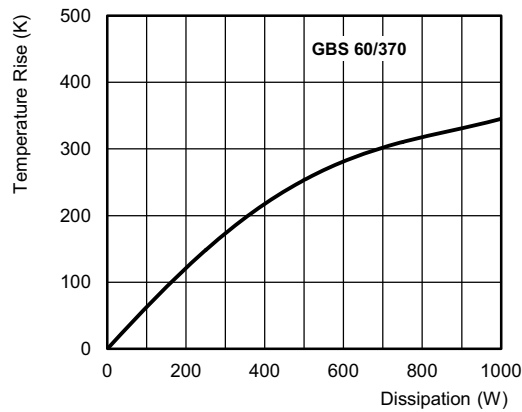
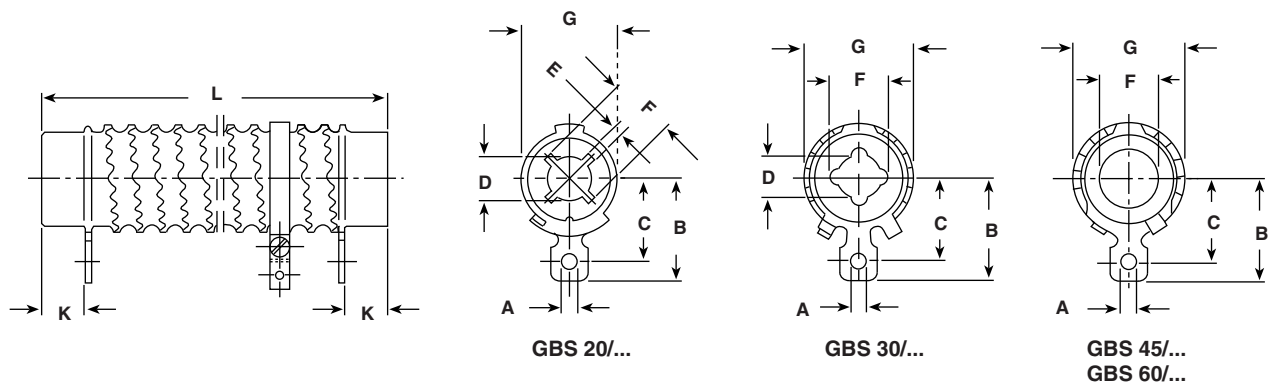
TEMPERATURE RISE

DIMENSIONS AND MASS

TYPE / VARIANT	L (mm)	K (mm)	A (mm)	B (mm)	C (mm)	D (mm)	E (mm)	F (mm)	G (mm)	MASS (g)
GBS 20/100 GBS 20/100 E	100.0 ± 2.5	15.0	4.2	26.5	22.0	10.0	1.5	14.0	24.0	100
GBS 20/165 GBS 20/165 E	165.0 ± 4.0	15.0	4.2	26.5	22.0	10.0	1.5	14.0	24.0	150
GBS 20/265 GBS 20/265 E	265.0 ± 6.6	15.0	4.2	26.5	22.0	10.0	1.5	14.0	24.0	250
GBS 30/100 GBS 30/100 E	100.0 ± 2.5	15.0	5.2	34.0	28.0	14.0	-	18.5	37.0 ± 1.0	200
GBS 30/133 GBS 30/133 E	133.0 ± 3.3	15.0	5.2	34.0	28.0	14.0	-	18.5	37.0 ± 1.0	250
GBS 30/165 GBS 30/165 E	165.0 ± 4.0	15.0	5.2	34.0	28.0	14.0	-	18.5	37.0 ± 1.0	300
GBS 30/215 GBS 30/215 E	215.0 ± 5.4	15.0	5.2	34.0	28.0	14.0	-	18.5	37.0 ± 1.0	400
GBS 30/265 GBS 30/265 E	265.0 ± 6.6	15.0	5.2	34.0	28.0	14.0	-	18.5	37.0 ± 1.0	500
GBS 30/330 GBS 30/330 E	330.0 ± 8.0	15.0	5.2	34.0	28.0	14.0	-	18.5	37.0 ± 1.0	600
GBS 45/370 GBS 45/370 E	370.0 ± 9.0	15.0	5.2	42.5	37.0	-	-	30.0	52.0 ± 1.0	1000
GBS 60/370 GBS 60/370 E	370.0 ± 9.0	15.0	5.2	51.5	45.5	-	-	45.0	67.0 ± 1.0	1200



Disclaimer

ALL PRODUCT, PRODUCT SPECIFICATIONS AND DATA ARE SUBJECT TO CHANGE WITHOUT NOTICE TO IMPROVE RELIABILITY, FUNCTION OR DESIGN OR OTHERWISE.

Vishay Intertechnology, Inc., its affiliates, agents, and employees, and all persons acting on its or their behalf (collectively, "Vishay"), disclaim any and all liability for any errors, inaccuracies or incompleteness contained in any datasheet or in any other disclosure relating to any product.

Vishay makes no warranty, representation or guarantee regarding the suitability of the products for any particular purpose or the continuing production of any product. To the maximum extent permitted by applicable law, Vishay disclaims (i) any and all liability arising out of the application or use of any product, (ii) any and all liability, including without limitation special, consequential or incidental damages, and (iii) any and all implied warranties, including warranties of fitness for particular purpose, non-infringement and merchantability.

Statements regarding the suitability of products for certain types of applications are based on Vishay's knowledge of typical requirements that are often placed on Vishay products in generic applications. Such statements are not binding statements about the suitability of products for a particular application. It is the customer's responsibility to validate that a particular product with the properties described in the product specification is suitable for use in a particular application. Parameters provided in datasheets and / or specifications may vary in different applications and performance may vary over time. All operating parameters, including typical parameters, must be validated for each customer application by the customer's technical experts. Product specifications do not expand or otherwise modify Vishay's terms and conditions of purchase, including but not limited to the warranty expressed therein.

Hyperlinks included in this datasheet may direct users to third-party websites. These links are provided as a convenience and for informational purposes only. Inclusion of these hyperlinks does not constitute an endorsement or an approval by Vishay of any of the products, services or opinions of the corporation, organization or individual associated with the third-party website. Vishay disclaims any and all liability and bears no responsibility for the accuracy, legality or content of the third-party website or for that of subsequent links.

Except as expressly indicated in writing, Vishay products are not designed for use in medical, life-saving, or life-sustaining applications or for any other application in which the failure of the Vishay product could result in personal injury or death. Customers using or selling Vishay products not expressly indicated for use in such applications do so at their own risk. Please contact authorized Vishay personnel to obtain written terms and conditions regarding products designed for such applications.

No license, express or implied, by estoppel or otherwise, to any intellectual property rights is granted by this document or by any conduct of Vishay. Product names and markings noted herein may be trademarks of their respective owners.