



















- 1 
- 2 
- 3 
- 4 
- 5 
- 6 
- 7 
- 8 
- 9 
- 10 
- 11 
- 12 
- 13 
- 14 
- 15 
- 16 
- 17 
- 18 

BASE

Glass-fibre reinforced polyamide based (PA) technopolymer, black colour, matte finish.

ARTICULATED THROUGH STEM

Threaded zinc-plated steel with regulation hexagon.
Assembled to the base by means of zinc-plated steel set screw and washer.

CUP WASHER FOR STEM BEARING

Glossy zinc-plated steel.

STANDARD EXECUTIONS

- **LV.A-ACV**: without no-slip disk.
- **LV.A-ACV-AS**: with NBR rubber no-slip disk, hardness 90 Shore A, supplied assembled with reinforced zinc-plated steel plate fixed by means of two screws.

FEATURES

The special knurling under the lower lip of the base provides excellent stability and grip when using the levelling element without no-slip disk even on surfaces that are not perfectly flat.

The components of the levelling elements (base and stem) are supplied already assembled.

ACCESSORIES ON REQUEST

Zinc-plated steel nut (see Nuts NT. on page 1137).

SPECIAL EXECUTIONS ON REQUEST

AISI 304 stainless steel stems.



ELESA Original design

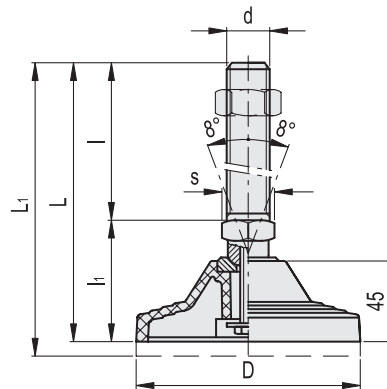

LV.A-ACV

LV.A-ACV-AS

Code	Description	Code	Description	D	d	L	L1#	l	li	s	Max. limit stati load* [N]	⚖️	⚖️#
306921	LV.A-125-ACV-M20x136	310921	LV.A-125-ACV-AS-M20x136	125	M20	200	210	136	64	24	40000	580	830
306925	LV.A-125-ACV-M20x186	310925	LV.A-125-ACV-AS-M20x186	125	M20	250	260	186	64	24	40000	690	940
306931	LV.A-125-ACV-M24x136	310931	LV.A-125-ACV-AS-M24x136	125	M24	200	210	136	64	24	40000	730	980
306935	LV.A-125-ACV-M24x186	310935	LV.A-125-ACV-AS-M24x186	125	M24	250	260	186	64	24	40000	840	1090
306941	LV.A-125-ACV-M30x136	310941	LV.A-125-ACV-AS-M30x136	125	M30	200	210	136	64	30	40000	940	1190
306945	LV.A-125-ACV-M30x186	310945	LV.A-125-ACV-AS-M30x186	125	M30	250	260	186	64	30	40000	1030	1280

* The max static load is the value above which the load applied to the element may cause some plastic material breakage, in particular conditions of use. Obviously, a factor that takes into consideration the importance and the safety level of the specific application must be applied to this value.

Data with no-slip disk mounted.