

Duplex filter

RE 51407/09.10
Replaces: 02.09

1/18

Types 40 FLDKN 0063 to 0630; 40 FLDK 0015 to 0120

Nominal sizes **according to DIN 24550**: 0063 to 0630
 Nominal sizes according to BRFS: 0015 to 0120
 Nominal pressures 40 bar
 Connections up to DN 80
 Operating temperature -10 °C to $+100\text{ °C}$



H7593

Table of contents

Contents	Page
Application, features	1
Design, filter element, accessories, characteristic curves, quality and standardization	2
Ordering details	3
Preferred types	4, 5
Ordering details: Electronic switching element for clogging indicator	6
Plug-in connectors	6
Symbols	7
Technical data	8
Characteristic curves	9...12
Unit dimensions	13, 14
Spart parts	15...17
Installation, commissioning, maintenance	18

Application

- Filtration of pressure fluids and lubricants.
- Filtration of fluids and gases.
- Direct installation into pipelines.
- Direct wear protection of downstream components and systems.
- Continuous operating mode due to duplex filter design.

Features

- Filters for inline installation
- Versatile applications
- Compact design
- Low pressure drop
- Special highly efficient filter media

Design

Two filter housings in cast design, connected by means of a ball valve with integrated pressure compensation. Vertically aligned connections for inlet and outlet at the front of the switch housing.

Materials as per spare parts list.

Further design variants available on request.

Filter element

Pleated design with optimized pleat density and various filter media.

The filter element is the most important component of the "FILTER" system in view of the prolonged life and the wear protection of the systems.

The most important criteria for selection are the required degree of cleanliness of the operating medium, the initial pressure differential and the contamination retention capacity.

For further detailed information please refer to our brochure "Filter Elements".

Accessories

Clogging indicator

Basically, the filter is equipped with mechanical optical clogging indicator. The electronic clogging indicator is connected via the electronic switching element with 1 or 2 switching points, which has to be ordered separately. The electronic switching element is attached to the mechanical optical clogging indicator and held by means of a locking ring.

Bypass valve

To protect the filter element during startup and over pressurization due to clogging.

Characteristic curves

An optimum filter selection is made possible by our "BRFilterSelect" software, see download area <http://www.eppensteiner.de>.

Additional characteristic curves for the filters in this catalogue can be found in the BRFS filter calculation program.

Quality and standardization

The development, manufacture, and assembly of BRFS industrial filters and BRFS filter elements is carried out within the framework of a certified quality management system in accordance with ISO 9001:2000.

The pressure filters for hydraulic applications according to 51407 are pressure holding equipment according to article 1, section 2.1.4 of the pressure equipment directive 97/23/EC (DGRL). However, on the basis of the exception in article 1, section 3.6 of the DGRL, hydraulic filters are exempt from the DGRL if they are not classified higher than category I (guideline 1/19). They do not receive a CE mark.

Ordering details

of the filter

40	-	A	-	0	-	V2,2	-	D0			
Pressure 40 bar = 40											
Design Duplex filter with ball valve change over valve with filter element according to DIN 24550 = FLDKN Duplex filter with ball valve change over valve with filter element according to BRFS standard = FLDK											Complementary details 0 = without Z ²⁾ = Certificate
Nom. size FLDKN... = 0063 0100 0160 0250 0400 0630 FLDK... = 0015 0018 0045 0055 0120											Material 0 = Standard D ¹⁾ = chemically nickel-plated
Filtration rating in µm nominal Stainless steel wire mesh, cleanable: G10, G25 = G... Paper, non-cleanable P10 = P...											Seal M = NBR seal V = FKM seal
absolute (ISO 16889) Micro glass, non-cleanable H3XL, H10XL, H20XL = H...XL											Connection D0 = DIN flange
Pressure differential Max. admissible pressure differential of the filter element 30 bar = A											Clogging indicator V2,2 = clogging indicator, optical state switching pressure 2.2 bar
Element model Standard adhesive T = 100 °C = 0... Standard material = ...0 chemically nickel-plated = ...D¹⁾											Bypass valve 0 = without 7 = 3.5 bar
Solenoid without = 0											

Ordering example:
40 FLDK 0063 H10XL-A00-07V2,2-D0M00

of the filter element

1.	-	A	-	0	-						
Filter element Design Design = 1.											
Nom. size FLDKN... = 0063 0100 0160 0250 0400 0630 FLDK... = 0015 0018 0045 0055 0120											Seal M = NBR seal V = FKM seal
Filtration rating in µm nominal Stainless steel wire mesh, cleanable: G10, G25 = G... Paper, non-cleanable: P10 = P...											Bypass valve 0 = with filter element always 0
absolute (ISO 16889) Micro glass, non-cleanable H3XL, H10XL, H20XL = H...XL											Element model 0... = Standard adhesive T = 100 °C ...0 = Standard material ...D ¹⁾ = chemically nickel-plated
Pressure differential Max. admissible pressure differential of the filter element 30 bar = A											

Ordering example:
1.0008 H10XL-A00-0-M

¹⁾ Only in connection with FKM seal

²⁾ Z = manufacturer's inspection certificate M according to DIN 55350 T18

Preferred types

Duplex filter with bypass, filtration rating 10 µm and nominal pressure 40 bar

Type	Flow in L/min at $v = 30 \text{ mm}^2/\text{s}$ and $\Delta p = 0.8 \text{ bar}$	Material number
40 FLDKN 0063 H10XL-A00-07V2,2-D0M00	88	R928000478
40 FLDKN 0100 H10XL-A00-07V2,2-D0M00	105	R928000479
40 FLDK 0015 H10XL-A00-07V2,2-D0M00	114	R928000480
40 FLDK 0018 H10XL-A00-07V2,2-D0M00	124	R928000481
40 FLDKN 0160 H10XL-A00-07V2,2-D0M00	290	R928000474
40 FLDKN 0250 H10XL-A00-07V2,2-D0M00	380	R928000475
40 FLDK 0045 H10XL-A00-07V2,2-D0M00	460	R928000482
40 FLDK 0055 H10XL-A00-07V2,2-D0M00	506	R928000483
40 FLDKN 0400 H10XL-A00-07V2,2-D0M00	690	R928000476
40 FLDKN 0630 H10XL-A00-07V2,2-D0M00	830	R928000477
40 FLDK 0120 H10XL-A00-07V2,2-D0M00	950	R928000484

Duplex filter with bypass, filtration rating 3 µm and nominal pressure 40 bar

Type	Flow in L/min at $v = 30 \text{ mm}^2/\text{s}$ and $\Delta p = 0.8 \text{ bar}$	Material number
40 FLDKN 0063 H3XL-A00-07V2,2-D0M00	45	R928000467
40 FLDKN 0100 H3XL-A00-07V2,2-D0M00	65	R928000468
40 FLDK 0015 H3XL-A00-07V2,2-D0M00	79	R928000469
40 FLDK 0018 H3XL-A00-07V2,2-D0M00	98	R928000470
40 FLDKN 0160 H3XL-A00-07V2,2-D0M00	130	R928000463
40 FLDKN 0250 H3XL-A00-07V2,2-D0M00	198	R928000464
40 FLDK 0045 H3XL-A00-07V2,2-D0M00	285	R928000471
40 FLDK 0055 H3XL-A00-07V2,2-D0M00	350	R928000472
40 FLDKN 0400 H3XL-A00-07V2,2-D0M00	355	R928000465
40 FLDKN 0630 H3XL-A00-07V2,2-D0M00	515	R928000466
40 FLDK 0120 H3XL-A00-07V2,2-D0M00	732	R928000473

Preferred types

Duplex filter without bypass, filtration rating 10 µm and nominal pressure 40 bar

Type	Flow in L/min at $v = 30 \text{ mm}^2/\text{s}$ and $\Delta p = 0.8 \text{ bar}$	Material number
40 FLDKN 0063 H10XL-A00-00V2,2-D0M00	88	R928020261
40 FLDKN 0100 H10XL-A00-00V2,2-D0M00	105	R928020262
40 FLDK 0015 H10XL-A00-00V2,2-D0M00	114	R928020263
40 FLDK 0018 H10XL-A00-00V2,2-D0M00	124	R928020264
40 FLDKN 0160 H10XL-A00-00V2,2-D0M00	290	R928020257
40 FLDKN 0250 H10XL-A00-00V2,2-D0M00	380	R928020258
40 FLDK 0045 H10XL-A00-00V2,2-D0M00	460	R928020265
40 FLDK 0055 H10XL-A00-00V2,2-D0M00	506	R928020266
40 FLDKN 0400 H10XL-A00-00V2,2-D0M00	690	R928020259
40 FLDKN 0630 H10XL-A00-00V2,2-D0M00	830	R928020260
40 FLDK 0120 H10XL-A00-00V2,2-D0M00	950	R928020267

Duplex filter without bypass, filtration rating 3 µm and nominal pressure 40 bar

Type	Flow in L/min at $v = 30 \text{ mm}^2/\text{s}$ and $\Delta p = 0.8 \text{ bar}$	Material number
40 FLDKN 0063 H3XL-A00-00V2,2-D0M00	45	R928020250
40 FLDKN 0100 H3XL-A00-00V2,2-D0M00	65	R928020251
40 FLDK 0015 H3XL-A00-00V2,2-D0M00	79	R928020252
40 FLDK 0018 H3XL-A00-00V2,2-D0M00	98	R928020253
40 FLDKN 0160 H3XL-A00-00V2,2-D0M00	130	R928020246
40 FLDKN 0250 H3XL-A00-00V2,2-D0M00	198	R928020247
40 FLDK 0045 H3XL-A00-00V2,2-D0M00	285	R928020254
40 FLDK 0055 H3XL-A00-00V2,2-D0M00	350	R928020255
40 FLDKN 0400 H3XL-A00-00V2,2-D0M00	355	R928020248
40 FLDKN 0630 H3XL-A00-00V2,2-D0M00	515	R928020249
40 FLDK 0120 H3XL-A00-00V2,2-D0M00	732	R928020256

Ordering details: electronic switching element for clogging indicator

ABZ	F	V	1X	-DIN
Rexroth power unit accessories	Filter	Clogging indicator	electronic switching element with 1 switching point (changeover) round plug-in connection M12x1 = E1SP-M12X1	-DIN = Identification for DIN and SAE models Unit series unit series 10 to 19 (10 to 19; unchanged installation and connection dimensions)
			electronic switching element with 2 switching points (normally open/normally closed), 75%, 100%, round plug-in connection M12x1, 3 LED = E2SP-M12X1	1X =
			electronic switching element with 2 switching points (normally open/normally closed), 75%, 100%, signal suppression until 30 °C round plug-in connection M12x1, 3 LED = E2SPSU-M12X1	

Electronic switching element	Material no.
ABZFV-E1SP-M12X1-1X/-DIN	R901025339
ABZFV-E2SP-M12X1-1X/-DIN	R901025340
ABZFV-E2SPSU-M12X1-1X/-DIN	R901025341

Ordering example: Pressure filter with mechanical optical clogging indicator for $p_{nom.} = 40 \text{ bar}$ [580 psi] with bypass valve, nominal size 0063, with filter element 10 μm and electronic switching element M12x1 with 1 switching point for pressure liquid mineral oil HLP according to DIN 51524.

Filter: 40 FLDKN 0063 H10XL-A00-07V2,2-D0M00 **Material number: R928000478**

Clogging indicator: ABZFV-E1SP-M12X1-1X/-DIN **Material number: R901025339**

Plug-in connectors according to IEC 60947-5-2 (dimensions in mm [inch])

for electronic switching element with round plug-in connection M12 x 1

Plug-in connector for K24 4-pin, M12 x 1 with screwed connection, cable fitting Pg9.

Material no. R900031155

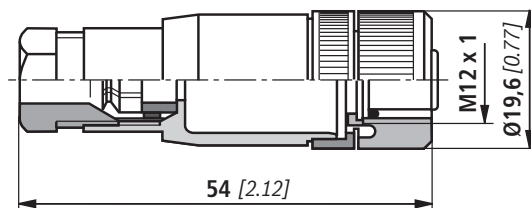

Plug-in connector for K24-3m 4-pin, M12 x 1 with molded in PVC cable, 3 m long.

Line cross-section: 4 x 0.34 mm²

Core marking:

1	brown
2	white
3	blue
4	black

Material no. R900064381

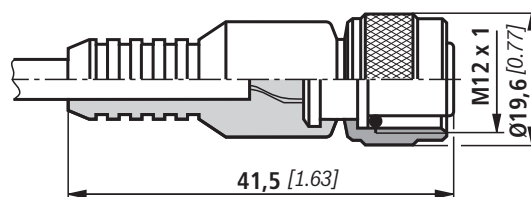

For additional round plug-in connections, see data sheet 08006.

Symbols

Pressure filter with bypass and mechanical display

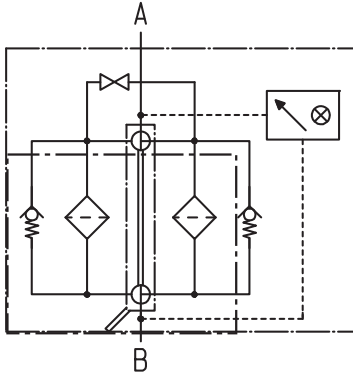

Pressure filter without bypass and mechanical display

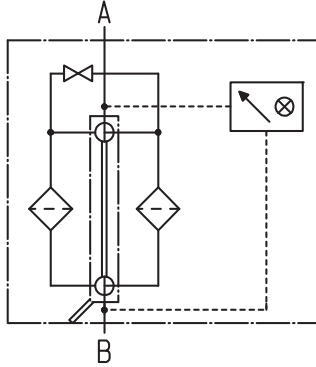

Electronic switching element for clogging indicator

Switching element Plug

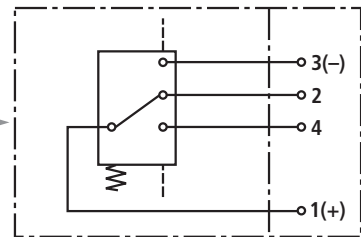

ABZFV-E1SP-M12X1-1X/-DIN

Switching element Plug

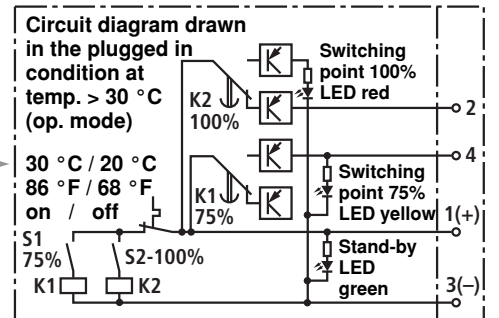

ABZFV-E2SPSU-M12X1-1X/-DIN

Switching element Plug

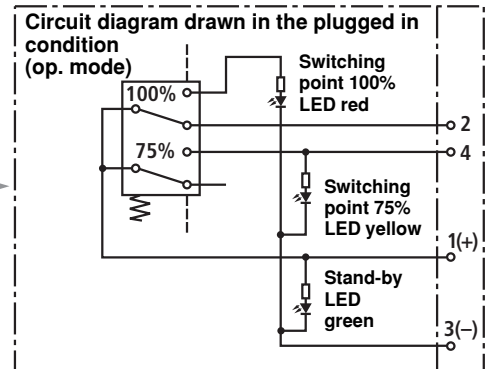

ABZFV-E2SP-M12X1-1X/-DIN

Technical data (for applications outside these parameters, please consult us!)**Electronic** (electric switching element)

Electrical connection		Round plug-in connection M12 x 1, 4-pin
Contact load, direct voltage	A	Max. 1
Voltage range	E1SP-M12x1 V DC/AC	Max. 150
	E2SP V DC	10 to 30
Max. switching capacity with ohmic loads		20 VA; 20 W; (70 VA)
Switching type	E1SP-M12x1	Changeover
	E2SP-M12x1	Normally open at 75% of the response pressure, Normally closed at 100% of the response pressure
	E2SPSU-M12x1	Normally open at 75% of the response pressure, Normally closed at 100% of the response pressure Signal switching through at 30 °C [86 °F], Return switching at 20 °C [68 °F]
Display via LEDs in the electronic switching element E2SP...		Stand-by (LED green); 75% switching point (LED yellow) 100% switching point (LED red)
Type of protection according to EN 60529		IP 65
For direct voltage above 24 V a spark suppression is to be provided to protect the switching contacts.		
Weight electronic switching element: – with round plug-in connection M12 x 1	kg [lbs]	0.1 [0.22]

Characteristic curves

H3XL...

Specific weight: $< 0.9 \text{ kg/dm}^3$
 Δp -Q characteristic curves for complete filters recommended
 initial Δp for design = 0.8 bar

An optimum filter selection is made possible by our computer program "BRFilterSelect".

Oil viscosity:
 — 120 mm^2/s
 - · - 46 mm^2/s
 - - - 30 mm^2/s

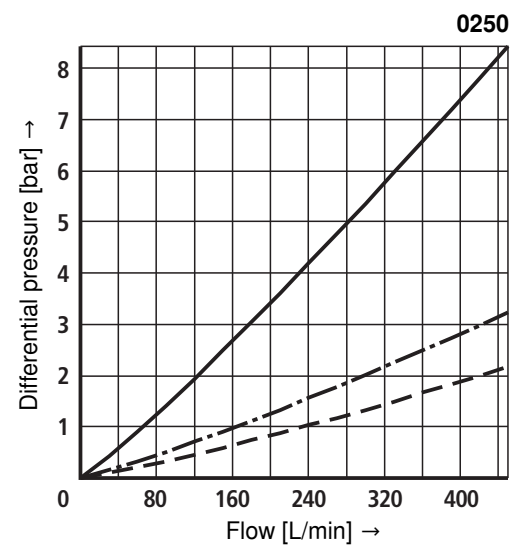
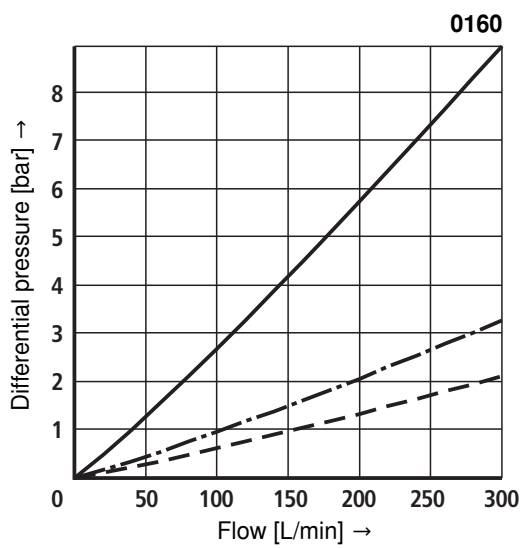
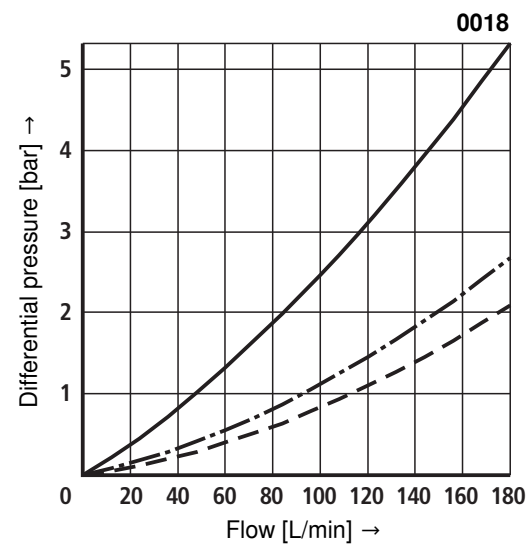
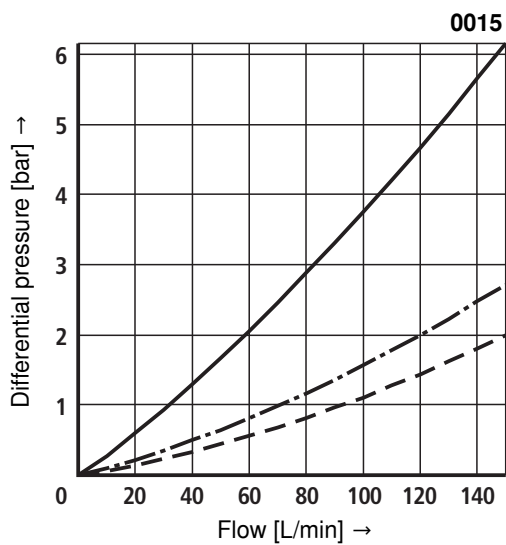
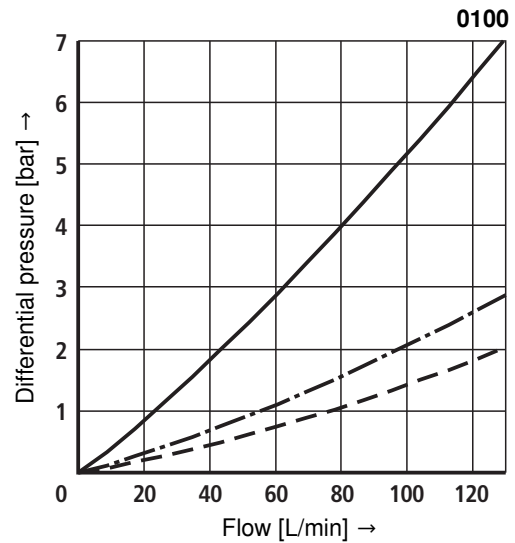
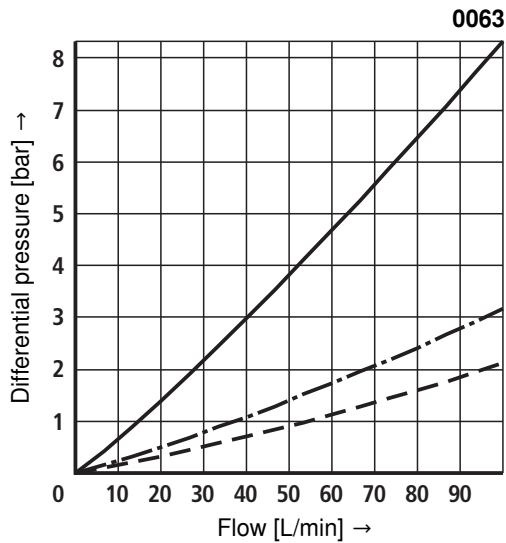

Characteristic curves

H3XL...

Specific weight: $< 0.9 \text{ kg/dm}^3$
 Δp -Q characteristic curves for complete filters recommended
 initial Δp for design = 0.8 bar

An optimum filter selection is made possible by our computer program "BRFilterSelect".

Oil viscosity:
 ——— 120 mm²/s
 - · - · 46 mm²/s
 - - - 30 mm²/s

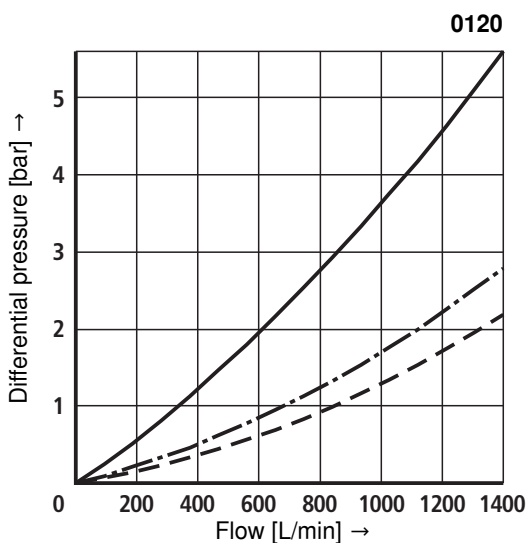
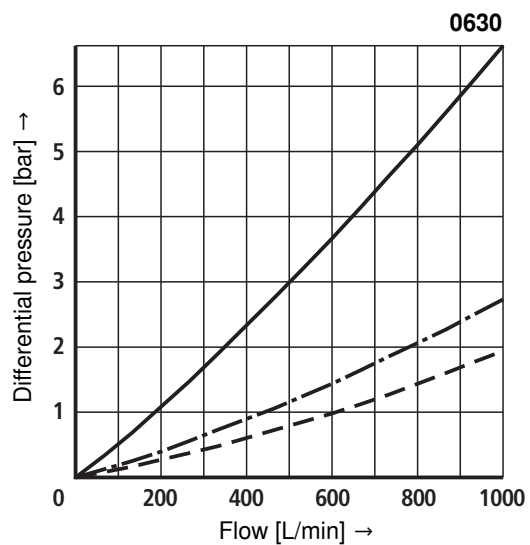
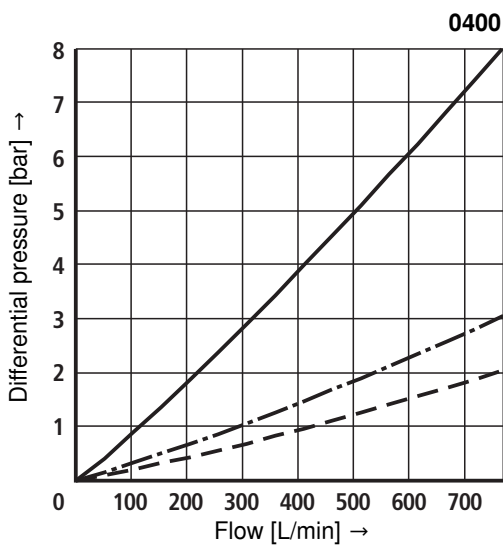
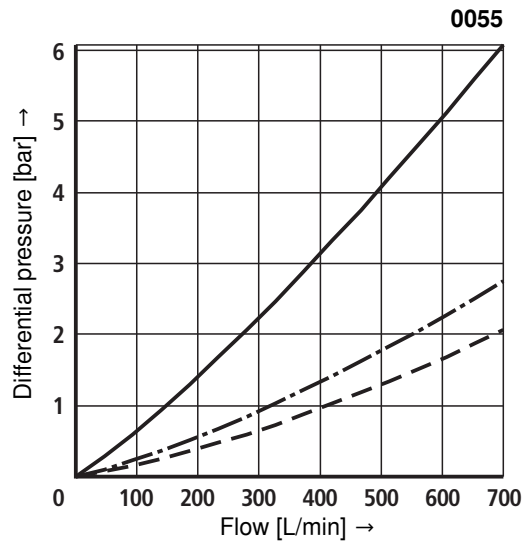
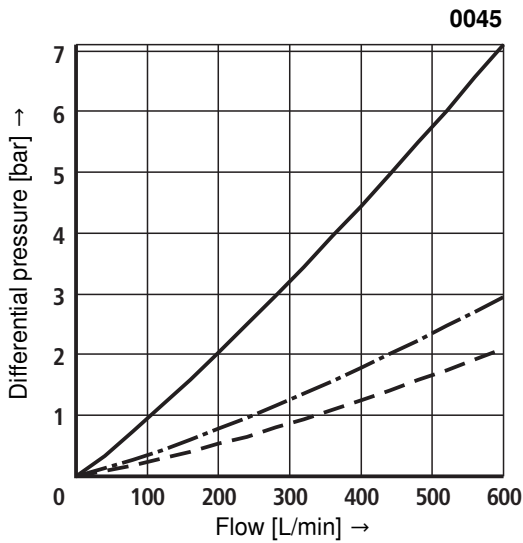

Characteristic curves

H10XL...

Specific weight: $< 0.9 \text{ kg/dm}^3$

Δp -Q characteristic curves for complete filters recommended
initial Δp for design = 0.8 bar

An optimum filter selection is made possible by our computer program "BRFilterSelect".

Oil viscosity:
 ——— 120 mm^2/s
 - - - 46 mm^2/s
 - - - 30 mm^2/s

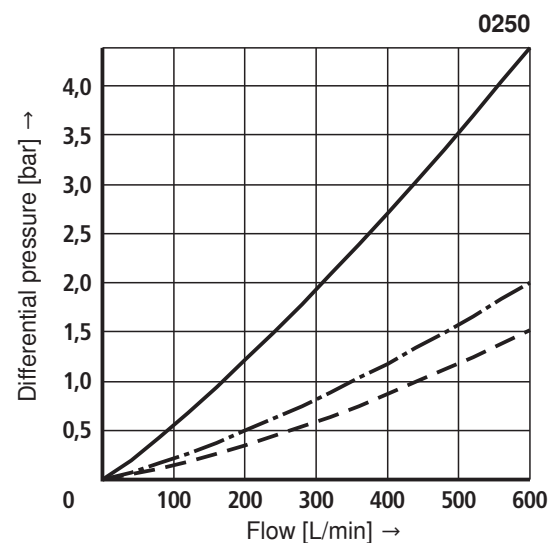
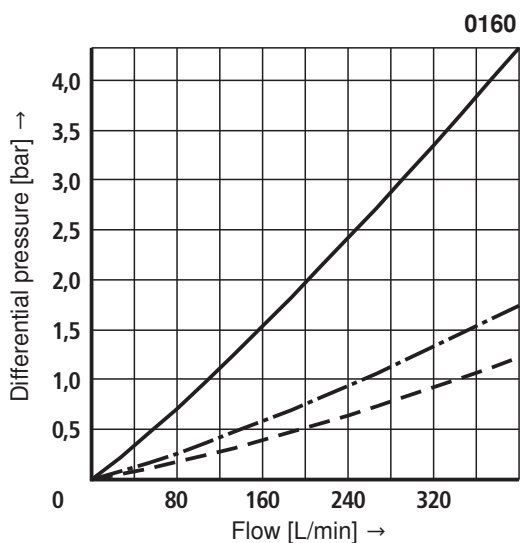
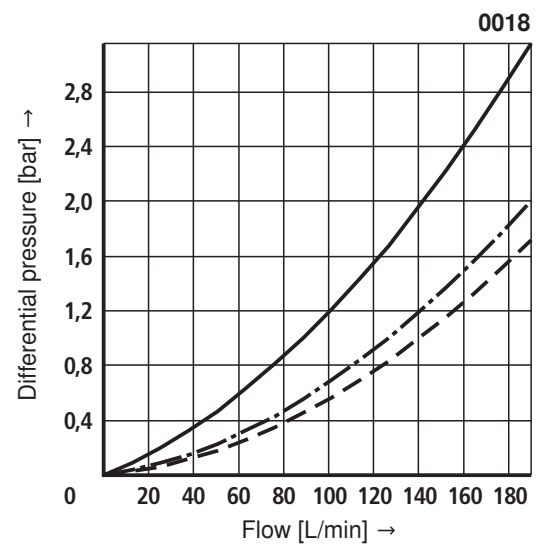
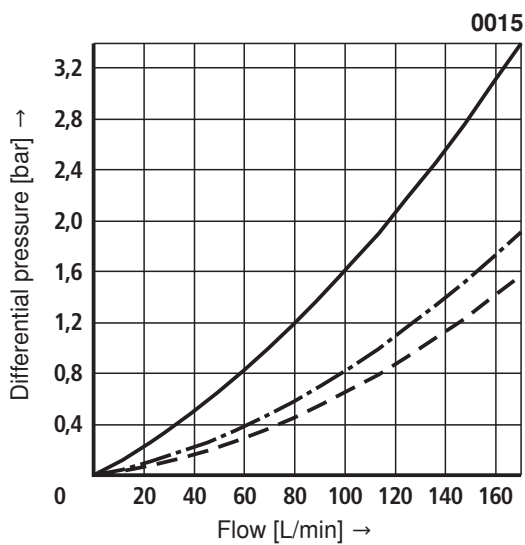
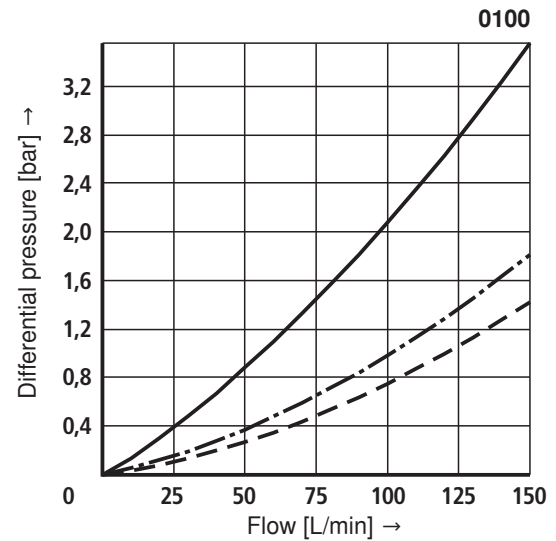
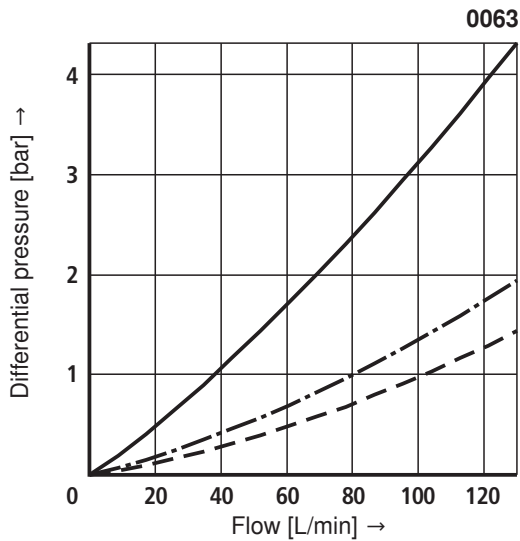

Characteristic curves

H10XL...

Specific weight: $< 0.9 \text{ kg/dm}^3$
 Δp -Q characteristic curves for complete filters recommended
 initial Δp for design = 0.8 bar

An optimum filter selection is made possible by our computer program "BRFilterSelect".

Oil viscosity:
 — 120 mm²/s
 - · - 46 mm²/s
 - - - 30 mm²/s

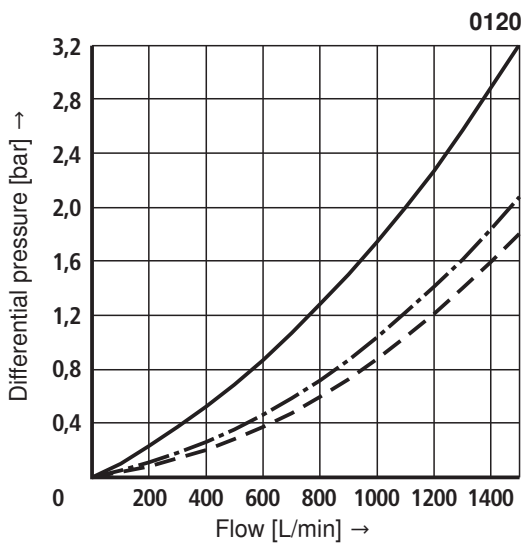
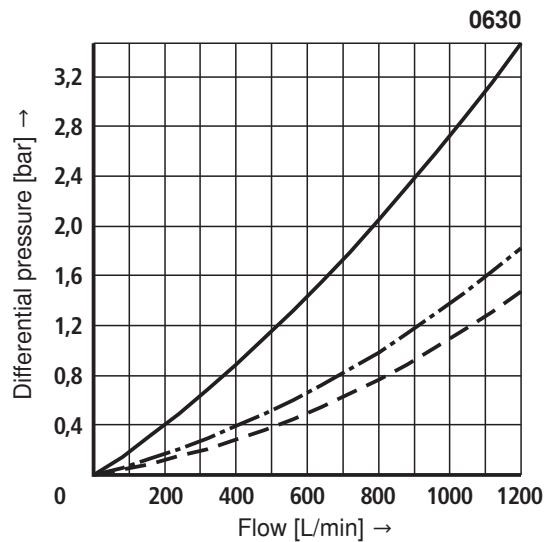
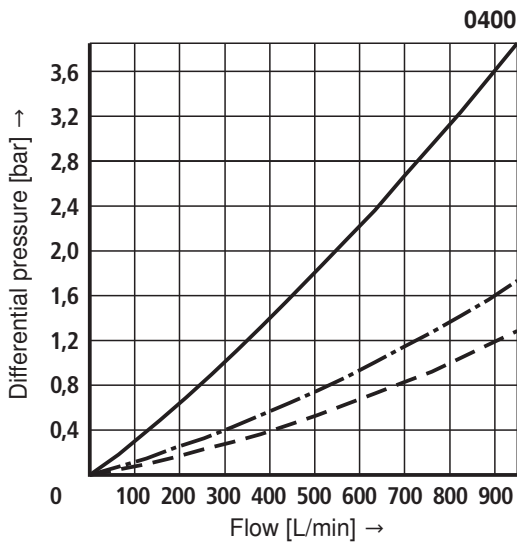
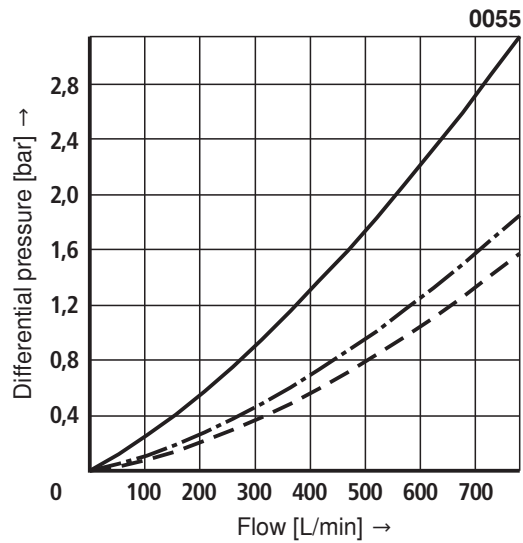
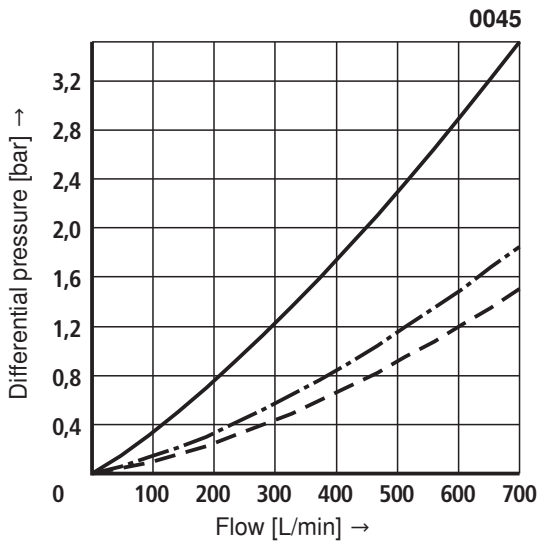

Unit dimensions

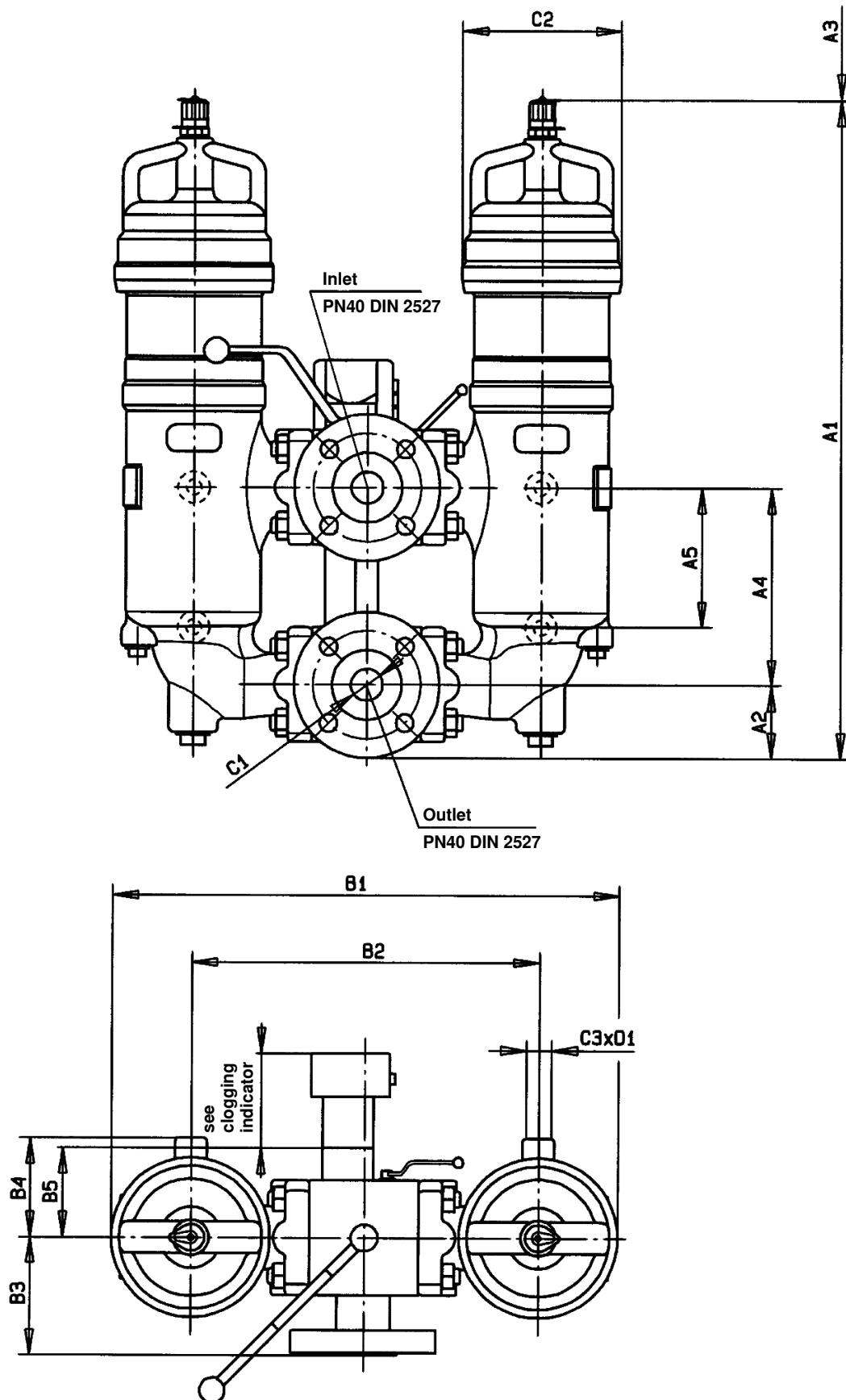

The changeover lever is located on the side that is in operation

Unit dimensions (dimensions in mm)**Filter housing for filter elements in accordance with DIN 24550**

Type	Content in L	Weight in kg ¹⁾	A1	A2	A3 ²⁾	A4	A5	B1	B2	B3	B4	B5	C1	C2	C3	D1
40 FLDKN 0063	2 x 1.5	39	416	95	160	155	110	399	274	92.5	77.5	70	DN 25	Ø 125	M12	18
40 FLDKN 0100	2 x 2.0	42	506		250											
40 FLDKN 0160	2 x 4.0	90	586	70	160	210	210	629	375	149	100	85	DN 50	Ø 158	M16	23
40 FLDKN 0250	2 x 4.0	90			250											
40 FLDKN 0400	2 x 9.0	152	686	100	250	230	230	729	484	155	115	130	DN 80	Ø 188	M20	22
40 FLDKN 0630	2 x 9.0	152	836		400											

Filter housing for filter elements according to BRFS standard

Type	Content in L	Weight in kg ¹⁾	A1	A2	A3 ²⁾	A4	A5	B1	B2	B3	B4	B5	C1	C2	C3	D1
40 FLDK 0015	2 x 1.5	39	416	95	164	155	110	399	274	92.5	77.5	70	DN 25	Ø 125	M12	18
40 FLDK 0018	2 x 2.0	42	506		254											
40 FLDK 0045	2 x 6.0	97	741	70	400	210	210	629	375	149	100	85	DN 50	Ø 158	M16	23
40 FLDK 0055	2 x 8.0	105	909		568											
40 FLDK 0120	2 x 16.0	161	1193	100	757	230	230	729	484	155	115	130	DN 80	Ø 188	M20	22

¹⁾ Weight including standard filter element and clogging indicator.

²⁾ Withdrawal dimension for filter element replacement.

Spare parts list

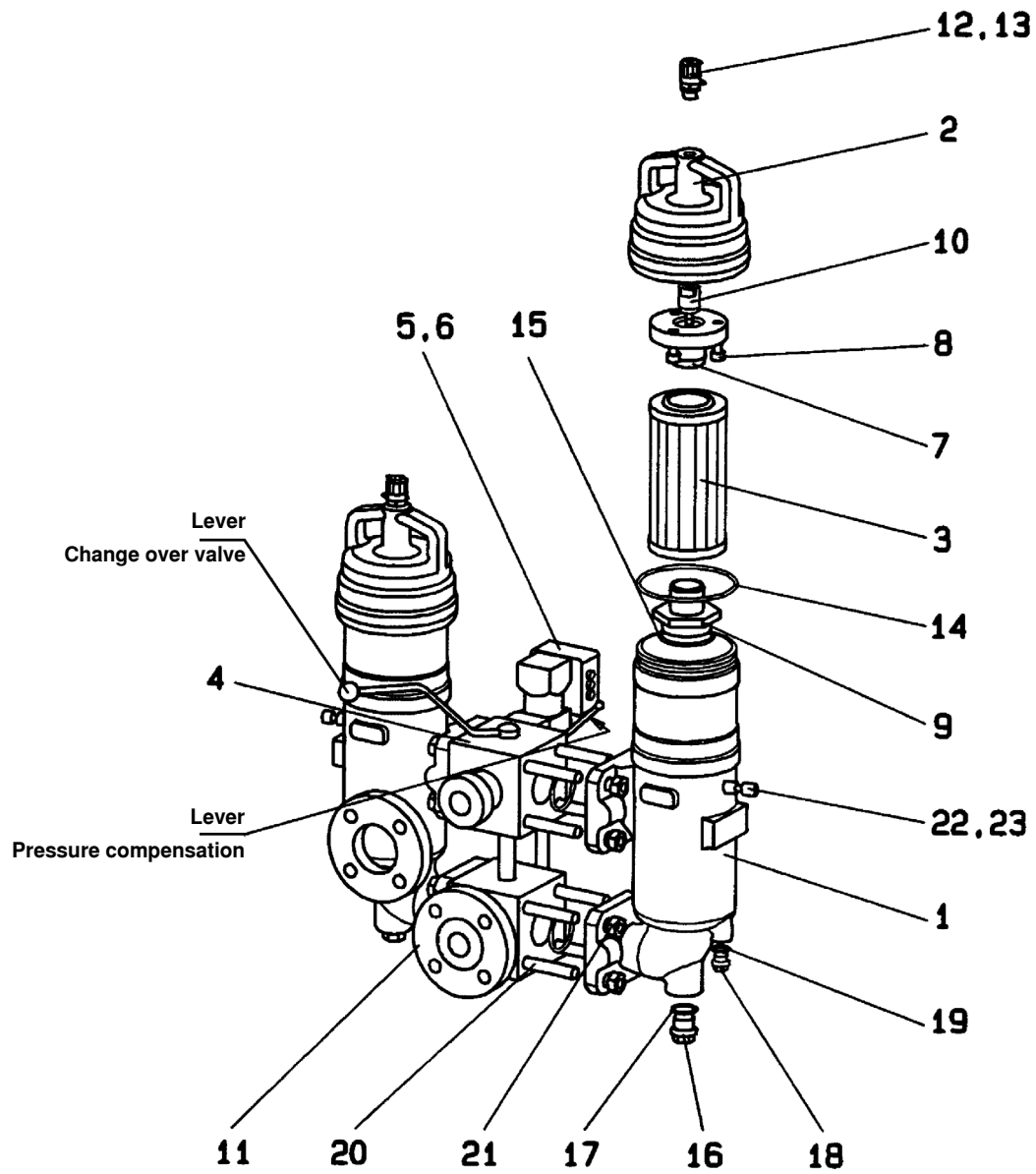

Spare parts list

Pos.	Piece	Size	FLDKN	0063	0100	0015	0018	0160	0250	0045	0055	0400	0630	0120			
		FLDKN; FLDK	FLDK	Parts number													
		Description	Material														
1	2	Filter housing	GGG50	Please indicate ordering information "Filter"													
2	2	Filter head	GkAlSi10Mg	Please indicate ordering information "Filter"													
3	2	Filter element	various	Please indicate ordering information "Filter Element"													
4	1	Ball valve combination	various	Please indicate ordering information "Filter"													
4.1	1	Ball valve Sealing kit	various	Please indicate ordering information "Filter"													
5	1	Clogging indicator	various	Please indicate ordering information "Clogging indicator"													
6	2	Seal ring	NBR / FKM	Please indicate ordering information "Filter"													
7	2	Centering spigot	AlCuMgPb	Please indicate ordering information "Filter"													
8	6	Socket head cap screw	8.8	637								652					
9	2	Centering spigot	AlCuMgPb	Please indicate ordering information "Filter"													
10	2	Bypass valve ¹⁾ or plug	various	5118				5360									
				793				825									
11	2	DIN flange	C22	5204				5296				4969					
12	2	Bleed screw	5.8	4158													
13	2	Seal ring	Soft steel	832													
14	2	Seal ring	NBR / FKM	Please indicate ordering information "Filter"													
15	2	Seal ring	NBR / FKM	Please indicate ordering information "Filter"													
16	2	Plug	Steel	789													
17	2	Seal ring	Soft steel	Please indicate ordering information "Filter"													
18	2	Plug	Steel	770													
19	2	Seal ring	Soft steel	Please indicate ordering information "Filter"													
20	16/32	Stud screw	8.8	9587(16x)				9586(16x)				9586(32x)					
21	16/32	Hexagonal nut	5	683(16x)				684(16x)				684(32x)					
22	2	Locking screw	various	-								4844					
23	2	Seal ring	Soft steel	-								Indicate ordering information "Filter"					

¹⁾ Please specify opening pressure.

All part numbers BRFS specific.

Spare parts (insert for DIN and SAE filters)

Mechanical optical clogging indicator

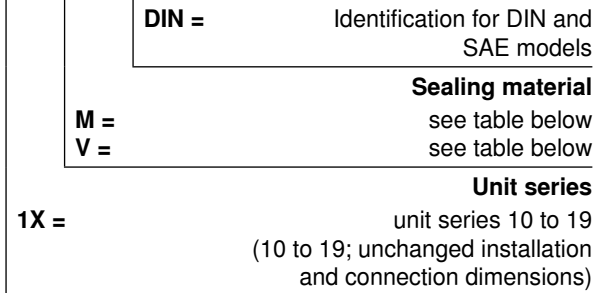
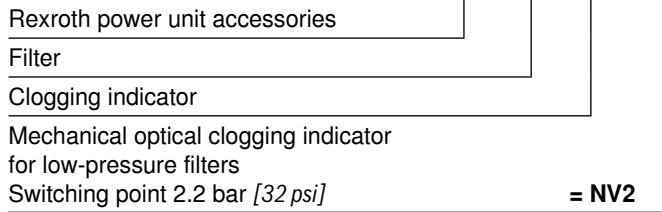
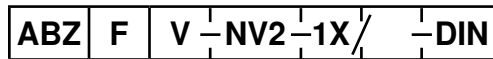

Mechanical optical clogging indicator	Material no.
ABZ FV-NV2-1X/M-DIN	R901025312

The ordering details for filter elements can be found in the order details on page 3.

Sealing kits must be ordered by stating the complete part key.

Sealing material and surface coating for pressure fluids

		Ordering details	
Mineral oils		Sealing material	Element model / and material
Mineral oil	HLP according to DIN 51524	M	...0
Fire-resistant hydraulic fluids			
Emulsions	HFA-E according to DIN 24320	M	...0
Synthetic water solutions	HFA-S according to DIN 24320	M	...D
Water solutions	HFC according to VDMA 24317	M	...D
Phosphate esters	HFD-R according to VDMA 24317	V	...D
Organic esters	HFD-U according to VDMA 24317	V	...D
Hydraulic fluids that are fast biodegradable			
Triglycerides (rape seed oil)	HETG according to VDMA 24568	M	...D
Synthetic esters	HEES according to VDMA 24568	V	...D
Polyglycoles	HEPG according to VDMA 24568	V	...D

Installation, commissioning and maintenance

Installation

Verify operating pressure with name plate information, mount the filter housing (pos. 1) on the fastening device, considering the withdrawal height of the filter element (pos.3).

Remove the plugs from the filter inlet and outlet. Connect inlet and outlet at the pipe work free of tension, considering the flow direction (direction arrows).

Warning!

Vessel is under pressure!

Assemble and disassemble the filter only when system is depressurized!

Keep the pressure compensation closed if the filter is open (vertical lever position)!

Do not operate the change over valve when the filter is opened!

Do not replace the clogging indicator and the pressure compensation while the filter is under pressure!

Functional and safety warranty only applicable when using genuine Rexroth spare parts!

Service filter only by trained personnel!

Commissioning

Switch on system pump, open the pressure compensation (horizontal lever position).

Bleed filter by opening the bleed screw (pos. 12), close when operating fluid vents. Pressure compensation remains open.

Maintenance

If at operating temperature, the red indicator pin shows out of the clogging indicator (pos. 5) so far that it contacts the plastic cap and/or if the switching process in the electric display is triggered, the filter element is clogged and needs to be replaced or cleaned respectively.

Filter element replacement

Actuate the switch-over lever and switch over to the second filter housing.

Close the pressure compensation (vertical lever position).

Depressurize the decommissioned filter housing.

Open bleed screw (pos. 12) by one turn.

Open the plugs (pos. 16 +18) and drain contaminated oil.

Screw off the filter head (pos. 2).

Pull off the filter element (pos. 3) from the centering spigot in the lower filter part by turning it lightly and remove it from the filter housing (pos. 1).

Close the plugs (pos. 16 + 18) and bleed screw (pos. 12) again. Check the filter housing for cleanliness and clean it, if necessary.

Replace filter elements H...XL and P..., clean the filter element with material G... . The efficiency of the cleaning process depends on the type of contamination and the value of the pressure differential.

If the pressure differential after replacing the element is more than 50% of the value before replacing the element then the G... filter element also needs to be replaced.

Install the cleaned or new filter element into the filter housing and, with light turning movements, plug it onto the centering spigot.

Beforehand apply some oil to the filter element seal ring. During installation take care to ensure that the filter element is not damaged at the top end of the filter housing.

Check the seal ring (pos. 14) in the filter head for damage or wear and replace if necessary. Without any tools, install filter head by rotating it clockwise by hand up to the last thread. Rotate back 1/4 rotation.

Open the pressure compensation (horizontal lever position). Bleed filter by opening the bleed screw (pos. 12), close when operating fluid vents.

Pressure compensation remains open.

Technical modifications reserved!