

SURGE SUPPRESSOR, RC COUPLING, AC 48...127V,
DC 70...150V, FOR MOTOR CONTACTORS SZ S0,

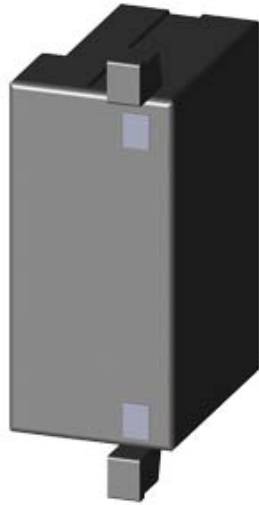

General technical data:

product brand name		SIRIUS
Product designation		surge suppressor
Size of contactor		S0
Design of the surge suppressor		with RC elements
Ambient temperature		
<ul style="list-style-type: none"> during storage 	°C	-40 ... +80
<ul style="list-style-type: none"> during operation 	°C	-25 ... +60

Control circuit/ Control:

Type of voltage of the control supply voltage		AC/DC
Control supply voltage frequency		
<ul style="list-style-type: none"> 1 Rated value 	Hz	50
<ul style="list-style-type: none"> 2 Rated value 	Hz	60
Control supply voltage 1		
<ul style="list-style-type: none"> for DC 		
<ul style="list-style-type: none"> <ul style="list-style-type: none"> Initial rated value 	V	70
<ul style="list-style-type: none"> <ul style="list-style-type: none"> Final rated value 	V	150
<ul style="list-style-type: none"> with AC 		
<ul style="list-style-type: none"> <ul style="list-style-type: none"> at 50 Hz Initial rated value 	V	48
<ul style="list-style-type: none"> <ul style="list-style-type: none"> at 50 Hz Final rated value 	V	127
<ul style="list-style-type: none"> <ul style="list-style-type: none"> at 60 Hz Final rated value 	V	127
<ul style="list-style-type: none"> <ul style="list-style-type: none"> at 60 Hz Initial rated value 	V	48







Installation/ mounting/ dimensions:

mounting position		any
-------------------	--	-----

Mounting type		clip-on
Width	mm	30
Height	mm	19
Depth	mm	12

Certificates/ approvals:

Certificate of suitability CE / UL / CSA / CCC

General Product Approval	Declaration of Conformity	Test Certificates	Shipping Approval
	 UL	 EG-Konf.	 Special Test Certificate
			 ABS
			 BUREAU VERITAS

Shipping Approval

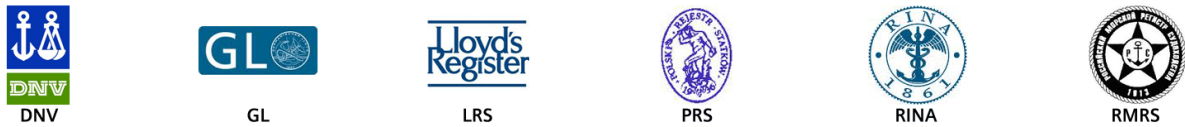

other

[Environmental Confirmations](#)

[Confirmation](#)



Further information

Information- and Downloadcenter (Catalogs, Brochures,...)

<http://www.siemens.com/industrial-controls/catalogs>

Industry Mall (Online ordering system)

<http://www.siemens.com/industrymall>

Cax online generator

<http://support.automation.siemens.com/WW/CAXorder/default.aspx?lang=en&mlfb=3RT29261CC00>

Service&Support (Manuals, Certificates, Characteristics, FAQs,...)

<http://support.automation.siemens.com/WW/view/en/3RT29261CC00/all>

Image database (product images, 2D dimension drawings, 3D models, device circuit diagrams, EPLAN macros, ...)

<http://www.automation.siemens.com/bilddb/index.aspx?attID9=3RT29261CC00&lang=en>

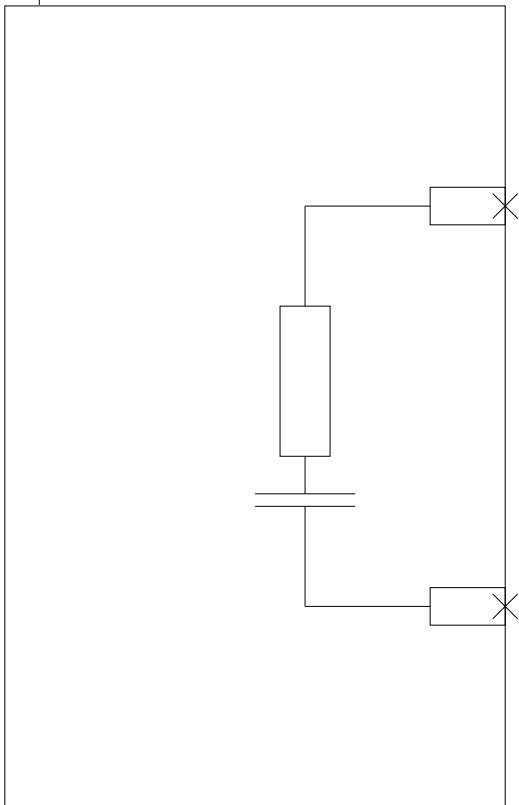
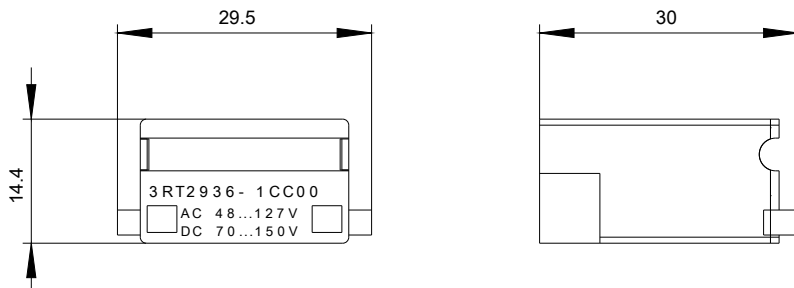

last modified:

09.03.2015