

**M12 MALE 0° / M12 FEMALE 90° LED**

PUR 4X0.34 GRAY, UL/CSA, drag ch 13m

Male straight to female 90°

M12 - M12, 4-pole

3 × LED (PNP), (NPN) on request

Art.-No. 7005 - M12 Lite - (plastic hexagonal screw) on request

Plastic housings with good resistance against chemicals and oils. The resistance to aggressive media should be individually tested for your application. Further details on request. Further cable lengths on request.

[Link to Product](#)**Illustration**

Male

Female



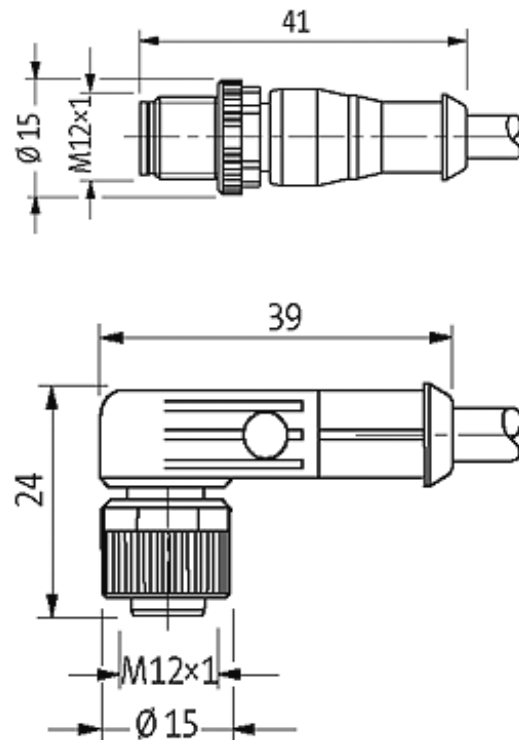

Product may differ from Image

### Approvals



\* only for products with UL/CSA approved cable

### Form

40341

### Technical Data

|                               |  |
|-------------------------------|--|
| Operating voltage             | 24 V DC $\pm 25\%$   |
| Operating current per contact | max. 4 A   |
| Locking of ports              | Screw thread M12 $\times$ 1 mm (recommended torque 0.6 Nm) self-securing |
| Protection                    | IP67 inserted and tightened (EN 60529)                                   |

### Cables

|                             |                                 |
|-----------------------------|---------------------------------|
| Cable number                | 234                             |
| No./diameter of wires       | 4 $\times$ 0.34 mm <sup>2</sup> |
| Wire isolation              | PP (br, wh, bl, bk)             |
| C-track properties          | 5 Mio.                          |
| Torsion                     | 2 Mio. $\pm$ 180°/m             |
| Jacket Color                | gray                            |
| Shore hardness outer jacket | 90 $\pm$ 5A                     |

|                            |                |
|----------------------------|----------------|
| Material (jacket)          | PUR (UL/CSA)   |
| Outer diameter             | approx. 4.7 mm |
| Bend radius (fixed)        | 5 × outer Ø    |
| Bend radius (moving)       | 10 × outer Ø   |
| Temperature range (fixed)  | -40...+80 °C   |
| Temperature range (mobile) | -25...+80 °C   |

**Commercial data**

|                        |          |
|------------------------|----------|
| country of origin      | DE       |
| customs tariff number  | 85444290 |
| minimum order quantity | 1        |