

# Die Set Crimp Tool Replacement

**DURATOOL**



## Features:

### 9PK-3003D1:

- 22 to 10 AWG insulated terminals/colour coded nests

### 9PK-3003D2:

- 22 to 12 AWG non-insulated open barrel connectors, commercial type

### 9PK-3003D3:

- Cambridge CP-88, CP-89, BNC/TC coax connectors with RG-58, RG-59/62 AU cables (Hex 0.35, 0.068 and 0.228)

### 9PK-3003D5:

- RG-58, RG-174 and RG-8218 for both 50 and 75 ohm cables (Hex 0.213, 0.178, 0.068 and 0.042)

### 9PK-3003D6:

- N-series and RG-8/11 connectors (Hex 0.429, 0.1 and 0.08)

### 9PK-3003D7:

- RG-174, mini 59 BNC/TC connectors (Hex 0.178, 0.128 and 0.068)

### 9PK-3003D10:

- RG-59, RG-6, F-type CATV connectors (Hex 0.35, 0.32 and 0.255)

### 9PK-3003D11:

- RJ-45, eight-position keyed or non-keyed modular plugs (excluding AMP)

### 9PK-3003D12:

- RJ-11, two, four and six-positions modular plugs

### 9PK-3003D13:

- RJ-11, DEC MMJ six-position modular plugs with an offset release tab

### 9PK-3003D14:

- AMP RJ-45 eight-position die modular plugs/primary strain relief crimp bar is located further back on die/modular plugs

### 9PK-3003D15:

- RG-58, RG-59/62, BNC/TNC coax connectors (Hex 0.255, 0.213 and 0.068)

9PK-3003D1

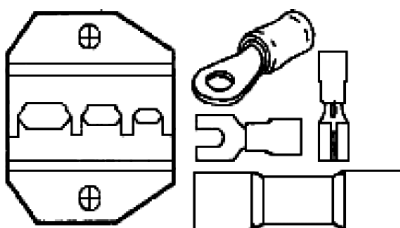

9PK-3003D3

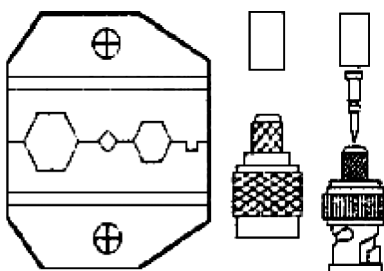

9PK-3003D2

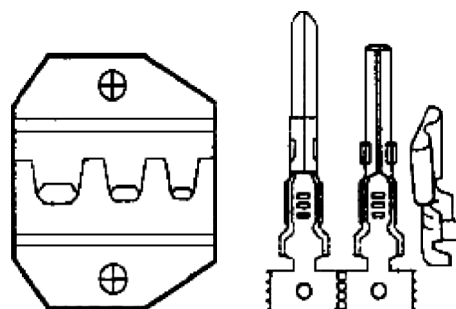

**DURATOOL**

# Die Set Crimp Tool Replacement

**DURATOOL**

9PK-3003D5

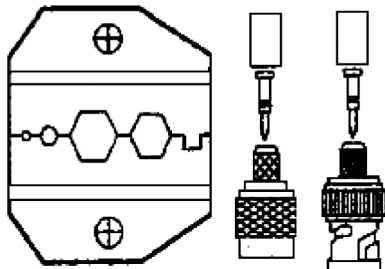

9PK-3003D6

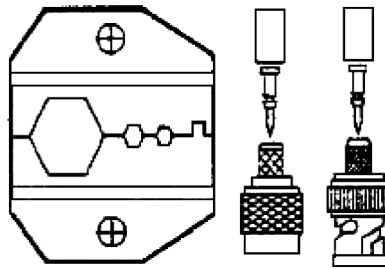

9PK-3003D7

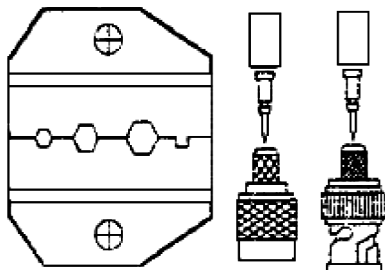

9PK-3003D10

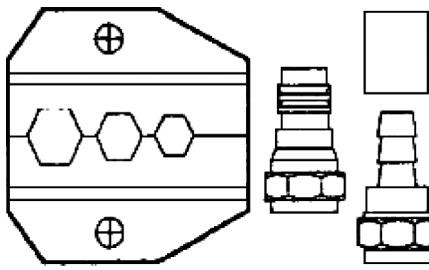

9PK-3003D11

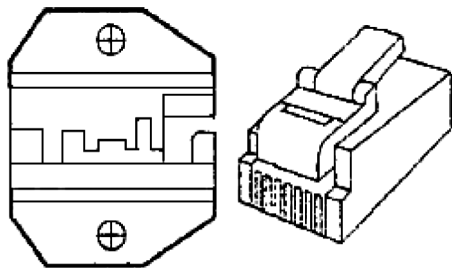

9PK-3003D13

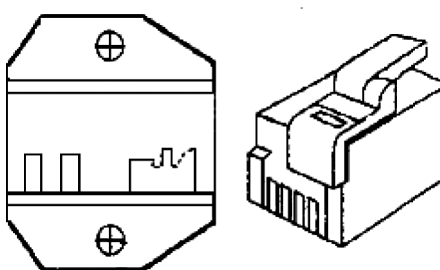

9PK-3003D12

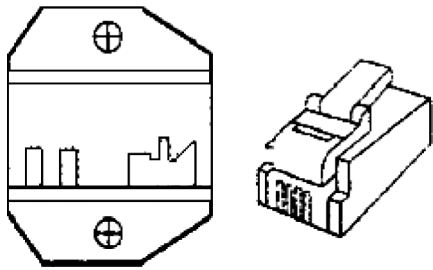

9PK-3003D14

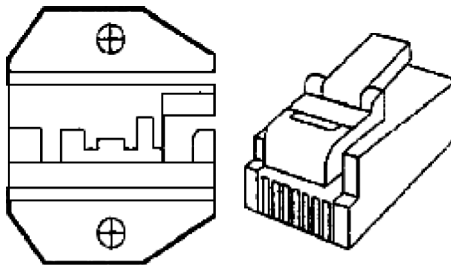

**DURATOOL**

# Die Set

## Crimp Tool Replacement



9PK-3003D15

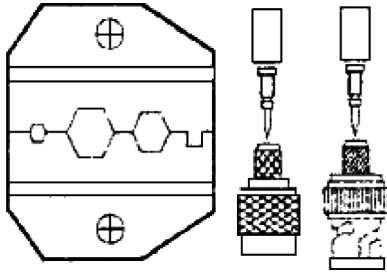

### Part Number Table

Description	Part number
Die Set, Insulated	9PK-3003D1
Die Set, Non-Insulated	9PK-3003D2
Die Set, Coaxial CP-88, CP-89	9PK-3003D3
Die Set, RG-58, RG-174	9PK-3003D5
Die Set, N Series	9PK-3003D6
Die Set, RG-174, Mini RG-59	9PK-3003D7
Die Set, RG-59, RG-6	9PK-3003D10
Die Set, RJ-45	9PK-3003D11
Die Set, RJ-11	9PK-3003D12
Die Set, RJ-11 DEC MMJ	9PK-3003D13
Die Set, AMP, RJ-45	9PK-3003D14
Die Set, RG-58, RG-59	9PK-3003D15

**Important Notice** : This data sheet and its contents (the "Information") belong to the members of the Premier Farnell group of companies (the "Group") or are licensed to it. No licence is granted for the use of it other than for information purposes in connection with the products to which it relates. No licence of any intellectual property rights is granted. The Information is subject to change without notice and replaces all data sheets previously supplied. The Information supplied is believed to be accurate but the Group assumes no responsibility for its accuracy or completeness, any error in or omission from it or for any use made of it. Users of this data sheet should check for themselves the Information and the suitability of the products for their purpose and not make any assumptions based on information included or omitted. Liability for loss or damage resulting from any reliance on the Information or use of it (including liability resulting from negligence or where the Group was aware of the possibility of such loss or damage arising) is excluded. This will not operate to limit or restrict the Group's liability for death or personal injury resulting from its negligence. DURATOOL is the registered trademark of the Group. © Premier Farnell plc 2012.

