

Preliminary

EasyPIM™ module with TRENCHSTOP™ IGBT7 and Emitter Controlled 7 diode and PressFIT / NTC

Features

- Electrical features
 - $V_{CES} = 1200\text{ V}$
 - $I_{C\text{nom}} = 100\text{ A} / I_{CRM} = 200\text{ A}$
 - TRENCHSTOP™ IGBT7
 - Low V_{CESat}
 - Overload operation up to 175°C
- Mechanical features
 - High power density
 - Compact design
 - Al_2O_3 substrate with low thermal resistance
 - 2.5 kV AC 1 min insulation
 - PressFIT contact technology



Potential applications

- Air conditioning
- Auxiliary inverters
- Motor drives
- Servo drives
- UPS systems

Product validation

- Qualified for industrial applications according to the relevant tests of IEC 60747, 60749 and 60068

Description

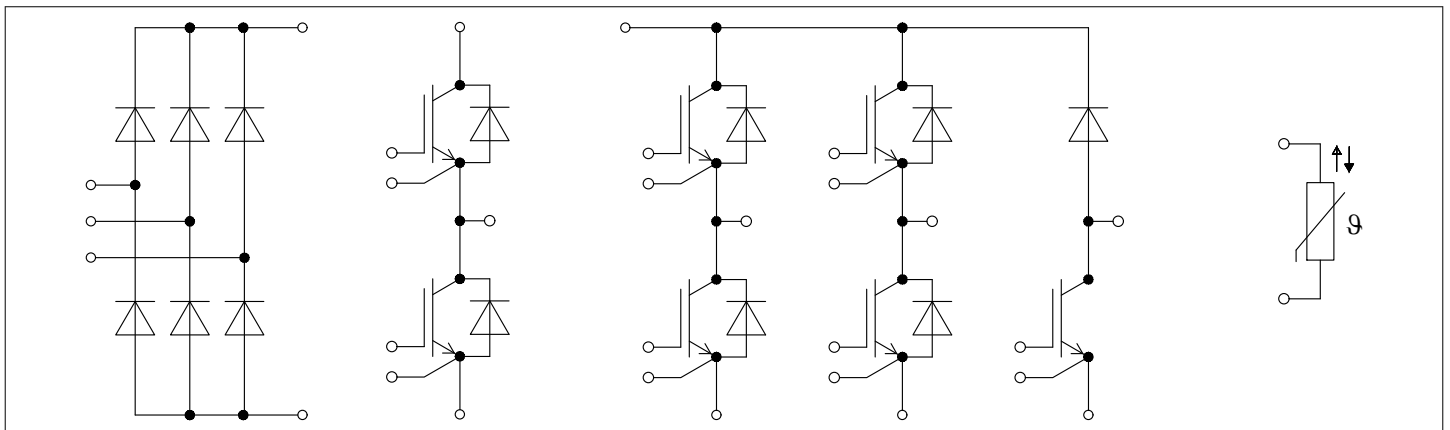

Table of contents

	Description	1
	Features	1
	Potential applications	1
	Product validation	1
	Table of contents	2
1	Package	3
2	IGBT, Inverter	3
3	Diode, Inverter	5
4	Diode, Rectifier	6
5	IGBT, Brake-Chopper	7
6	Diode, Brake-Chopper	9
7	NTC-Thermistor	10
8	Characteristics diagrams	11
9	Circuit diagram	17
10	Package outlines	17
	Revision history	18
	Disclaimer	19

1 Package

1 Package

Table 1 Insulation Coordination

Parameter	Symbol	Note or test condition	Values	Unit
Isolation test voltage	V_{ISOL}	RMS, $f = 50$ Hz, $t = 1$ min	2.5	kV
Internal Isolation		basic insulation (class 1, IEC 61140)	Al_2O_3	
Creepage distance	d_{Creep}	terminal to heatsink	11.2	mm
Creepage distance	d_{Creep}	terminal to terminal	6.8	mm
Clearance	d_{Clear}	terminal to heatsink	9.4	mm
Clearance	d_{Clear}	terminal to terminal	5.5	mm
Comperative tracking index	CTI		> 400	
RTI Elec.	RTI	housing	140	°C

Table 2 Characteristic Values

Parameter	Symbol	Note or test condition	Values			Unit
			Min.	Typ.	Max.	
Stray inductance module	L_{SCE}			35		nH
Module lead resistance, terminals - chip	$R_{AA'+CC'}$	$T_H = 25^\circ C$, per switch		2.8		mΩ
Module lead resistance, terminals - chip	$R_{CC'+EE'}$	$T_H = 25^\circ C$, per switch		2.2		mΩ
Storage temperature	T_{stg}		-40		125	°C
Mounting torque for modul mounting	M	- Mounting according to valid application note M5, Screw	1.3		1.5	Nm
Weight	G			78		g

Note: The current under continuous operation is limited to 25 A rms per connector pin.

2 IGBT, Inverter

Table 3 Maximum Rated Values

Parameter	Symbol	Note or test condition	Values	Unit
Collector-emitter voltage	V_{CES}	$T_{vj} = 25^\circ C$	1200	V
Continous DC collector current	I_{CDC}	$T_{vj\ max} = 175^\circ C$ $T_H = 65^\circ C$	100	A
Repetitive peak collector current	I_{CRM}	$t_p = 1$ ms	200	A
Gate-emitter peak voltage	V_{GES}		±20	V

Table 4 Characteristic Values

Parameter	Symbol	Note or test condition	Values			Unit	
			Min.	Typ.	Max.		
Collector-emitter saturation voltage	$V_{CE\ sat}$	$I_C = 100\ A,$ $V_{GE} = 15\ V$		$T_{vj} = 25\ ^\circ C$	1.50	TBD	V
				$T_{vj} = 125\ ^\circ C$	1.64		
				$T_{vj} = 175\ ^\circ C$	1.72		
Gate threshold voltage	V_{GEth}	$I_C = 2.5\ mA,$ $V_{CE} = V_{GE},$ $T_{vj} = 25\ ^\circ C$	5.15	5.80	6.45	V	
Gate charge	Q_G	$V_{GE} = \pm 15\ V,$ $V_{CE} = 600\ V$		1.8		μC	
Internal gate resistor	R_{Gint}	$T_{vj} = 25\ ^\circ C$		1.5		Ω	
Input capacitance	C_{ies}	$f = 100\ kHz,$ $T_{vj} = 25\ ^\circ C,$ $V_{CE} = 25\ V,$ $V_{GE} = 0\ V$		21.7		nF	
Reverse transfer capacitance	C_{res}	$f = 100\ kHz,$ $T_{vj} = 25\ ^\circ C,$ $V_{CE} = 25\ V,$ $V_{GE} = 0\ V$		0.076		nF	
Collector-emitter cut-off current	I_{CES}	$V_{CE} = 1200\ V,$ $V_{GE} = 0\ V$	$T_{vj} = 125\ ^\circ C$		0.009	mA	
Gate-emitter leakage current	I_{GES}	$V_{CE} = 0\ V,$ $V_{GE} = 20\ V,$ $T_{vj} = 25\ ^\circ C$			100	nA	
Turn on delay time (inductive load)	t_{don}	$I_C = 100\ A,$ $V_{CE} = 600\ V,$ $V_{GE} = \pm 15\ V,$ $R_{Gon} = 3.3\ \Omega$		$T_{vj} = 25\ ^\circ C$	0.163		μs
				$T_{vj} = 125\ ^\circ C$	0.184		
				$T_{vj} = 175\ ^\circ C$	0.193		
Rise time (inductive load)	t_r	$I_C = 100\ A,$ $V_{CE} = 600\ V,$ $V_{GE} = \pm 15\ V,$ $R_{Gon} = 3.3\ \Omega$		$T_{vj} = 25\ ^\circ C$	0.054		μs
				$T_{vj} = 125\ ^\circ C$	0.056		
				$T_{vj} = 175\ ^\circ C$	0.057		
Turn off delay time (inductive load)	t_{doff}	$I_C = 100\ A,$ $V_{CE} = 600\ V,$ $V_{GE} = \pm 15\ V,$ $R_{Goff} = 3.3\ \Omega$		$T_{vj} = 25\ ^\circ C$	0.328		μs
				$T_{vj} = 125\ ^\circ C$	0.410		
				$T_{vj} = 175\ ^\circ C$	0.459		

Table 4 Characteristic Values (continued)

Parameter	Symbol	Note or test condition	Values			Unit	
			Min.	Typ.	Max.		
Fall time (inductive load)	t_f	$I_C = 100\text{ A}$, $V_{CE} = 600\text{ V}$, $V_{GE} = \pm 15\text{ V}$, $R_{Goff} = 3.3\ \Omega$	$T_{vj} = 25\text{ °C}$ $T_{vj} = 125\text{ °C}$ $T_{vj} = 175\text{ °C}$		0.114		μs
					0.197		
					0.258		
Turn-on energy loss per pulse	E_{on}	$I_C = 100\text{ A}$, $V_{CE} = 600\text{ V}$, $L_\sigma = 35\text{ nH}$, $di/dt = 1900\text{ A}/\mu\text{s}$ ($T_{vj} = 175\text{ °C}$), $V_{GE} = \pm 15\text{ V}$, $R_{Gon} = 3.3\ \Omega$	$T_{vj} = 25\text{ °C}$ $T_{vj} = 125\text{ °C}$ $T_{vj} = 175\text{ °C}$		9.5		mJ
					12.6		
					14.3		
Turn-off energy loss per pulse	E_{off}	$I_C = 100\text{ A}$, $V_{CE} = 600\text{ V}$, $L_\sigma = 35\text{ nH}$, $du/dt = 3000\text{ V}/\mu\text{s}$ ($T_{vj} = 175\text{ °C}$), $V_{GE} = \pm 15\text{ V}$, $R_{Goff} = 3.3\ \Omega$	$T_{vj} = 25\text{ °C}$ $T_{vj} = 125\text{ °C}$ $T_{vj} = 175\text{ °C}$		6.85		mJ
					10.3		
					12.6		
SC data	I_{SC}	$V_{CC} = 800\text{ V}$, $V_{CEmax} = V_{CES} - L_{sCE} \cdot di/dt$	$t_p \leq 8\ \mu\text{s}$, $T_{vj} = 150\text{ °C}$ $t_p \leq 7\ \mu\text{s}$, $T_{vj} = 175\text{ °C}$		370		A
					350		
Thermal resistance, junction to heatsink	R_{thJH}	per IGBT, $\lambda_{grease} = 3.3\text{ W}/(\text{m} \cdot \text{K})$		0.510		K/W	
Temperature under switching conditions	$T_{vj\ op}$			-40	175	$^{\circ}\text{C}$	

Note: $T_{vj\ op} > 150\text{ °C}$ is allowed for operation at overload conditions. For detailed specifications, please refer to AN 2018-14.

3 Diode, Inverter

Table 5 Maximum Rated Values

Parameter	Symbol	Note or test condition	Values	Unit
Repetitive peak reverse voltage	V_{RRM}	$T_{vj} = 25\text{ °C}$	1200	V
Continuous DC forward current	I_F		100	A
Repetitive peak forward current	I_{FRM}	$t_p = 1\text{ ms}$	200	A

Table 5 Maximum Rated Values (continued)

Parameter	Symbol	Note or test condition	Values	Unit	
I ² t - value	I ² t	V _R = 0 V, t _p = 10 ms	T _{vj} = 125 °C	970	A ² s
			T _{vj} = 175 °C	860	

Table 6 Characteristic Values

Parameter	Symbol	Note or test condition	Values			Unit
			Min.	Typ.	Max.	
Forward voltage	V _F	I _F = 100 A, V _{GE} = 0 V	T _{vj} = 25 °C	1.72	TBD	V
			T _{vj} = 125 °C	1.59		
			T _{vj} = 175 °C	1.52		
Peak reverse recovery current	I _{RM}	V _R = 600 V, V _{GE} = -15 V, -di _F /dt = 1900 A/μs (T _{vj} = 175 °C)	T _{vj} = 25 °C	68.3		A
			T _{vj} = 125 °C	84.6		
			T _{vj} = 175 °C	92.8		
Recovered charge	Q _r	V _R = 600 V, V _{GE} = -15 V, -di _F /dt = 1900 A/μs (T _{vj} = 175 °C)	T _{vj} = 25 °C	9.38		μC
			T _{vj} = 125 °C	14.9		
			T _{vj} = 175 °C	19.1		
Reverse recovery energy	E _{rec}	V _R = 600 V, V _{GE} = -15 V, -di _F /dt = 1900 A/μs (T _{vj} = 175 °C)	T _{vj} = 25 °C	3.02		mJ
			T _{vj} = 125 °C	5.18		
			T _{vj} = 175 °C	6.5		
Thermal resistance, junction to heatsink	R _{thJH}	per diode, λ _{grease} = 3.3 W/(m*K)		0.870		K/W
Temperature under switching conditions	T _{vj op}		-40		175	°C

Note: T_{vj op} > 150°C is allowed for operation at overload conditions. For detailed specifications, please refer to AN 2018-14.

4 Diode, Rectifier

Table 7 Maximum Rated Values

Parameter	Symbol	Note or test condition	Values	Unit
Repetitive peak reverse voltage	V _{RRM}	T _{vj} = 25 °C	1600	V
Maximum RMS forward current per chip	I _{FRMSM}	T _H = 100 °C	100	A
Maximum RMS current at rectifier output	I _{RMSM}	T _H = 100 °C	100	A

Table 7 Maximum Rated Values (continued)

Parameter	Symbol	Note or test condition	Values	Unit
Surge forward current	I_{FSM}	$t_p = 10 \text{ ms}$ $T_{vj} = 25 \text{ }^\circ\text{C}$	1150	A
			$T_{vj} = 150 \text{ }^\circ\text{C}$	
I^2t - value	I^2t	$t_p = 10 \text{ ms}$ $T_{vj} = 25 \text{ }^\circ\text{C}$	6610	A^2s
			$T_{vj} = 150 \text{ }^\circ\text{C}$	

Table 8 Characteristic Values

Parameter	Symbol	Note or test condition	Values			Unit
			Min.	Typ.	Max.	
Forward voltage	V_F	$T_{vj} = 150 \text{ }^\circ\text{C}$, $I_F = 100 \text{ A}$		1.02		V
Reverse current	I_r	$T_{vj} = 150 \text{ }^\circ\text{C}$, $V_R = 1600 \text{ V}$		1		mA
Thermal resistance, junction to heatsink	R_{thJH}	per diode, $\lambda_{grease} = 3.3 \text{ W}/(\text{m}^*\text{K})$		0.700		K/W
Temperature under switching conditions	$T_{vj, op}$		-40		150	$^\circ\text{C}$

5 IGBT, Brake-Chopper

Table 9 Maximum Rated Values

Parameter	Symbol	Note or test condition	Values	Unit
Collector-emitter voltage	V_{CES}	$T_{vj} = 25 \text{ }^\circ\text{C}$	1200	V
Continuous DC collector current	I_{CDC}	$T_{vj, max} = 175 \text{ }^\circ\text{C}$ $T_H = 80 \text{ }^\circ\text{C}$	50	A
Repetitive peak collector current	I_{CRM}	$t_p = 1 \text{ ms}$	100	A
Gate-emitter peak voltage	V_{GES}		± 20	V

Table 10 Characteristic Values

Parameter	Symbol	Note or test condition	Values			Unit	
			Min.	Typ.	Max.		
Collector-emitter saturation voltage	$V_{CE, sat}$	$I_C = 50 \text{ A}$, $V_{GE} = 15 \text{ V}$		$T_{vj} = 25 \text{ }^\circ\text{C}$	1.50	TBD	V
				$T_{vj} = 125 \text{ }^\circ\text{C}$	1.64		
				$T_{vj} = 175 \text{ }^\circ\text{C}$	1.72		
Gate threshold voltage	V_{GEth}	$I_C = 1.28 \text{ mA}$, $V_{CE} = V_{GE}$, $T_{vj} = 25 \text{ }^\circ\text{C}$	5.15	5.80	6.45	V	

Table 10 Characteristic Values (continued)

Parameter	Symbol	Note or test condition	Values			Unit
			Min.	Typ.	Max.	
Gate charge	Q_G	$V_{GE} = \pm 15 \text{ V}$, $V_{CE} = 600 \text{ V}$		0.92		μC
Internal gate resistor	R_{Gint}	$T_{vj} = 25 \text{ }^\circ\text{C}$		0		Ω
Input capacitance	C_{ies}	$f = 100 \text{ kHz}$, $T_{vj} = 25 \text{ }^\circ\text{C}$, $V_{CE} = 25 \text{ V}$, $V_{GE} = 0 \text{ V}$		11.1		nF
Reverse transfer capacitance	C_{res}	$f = 100 \text{ kHz}$, $T_{vj} = 25 \text{ }^\circ\text{C}$, $V_{CE} = 25 \text{ V}$, $V_{GE} = 0 \text{ V}$		0.039		nF
Collector-emitter cut-off current	I_{CES}	$V_{CE} = 1200 \text{ V}$ $T_{vj} = 25 \text{ }^\circ\text{C}$			1	mA
Gate-emitter leakage current	I_{GES}	$V_{CE} = 0 \text{ V}$, $V_{GE} = 20 \text{ V}$, $T_{vj} = 25 \text{ }^\circ\text{C}$			100	nA
Turn on delay time (inductive load)	t_{don}	$I_C = 50 \text{ A}$, $V_{CE} = 600 \text{ V}$, $V_{GE} = \pm 15 \text{ V}$, $R_{Gon} = 5.1 \text{ } \Omega$	$T_{vj} = 25 \text{ }^\circ\text{C}$	0.045		μs
			$T_{vj} = 125 \text{ }^\circ\text{C}$	0.047		
			$T_{vj} = 175 \text{ }^\circ\text{C}$	0.048		
Rise time (inductive load)	t_r	$I_C = 50 \text{ A}$, $V_{CE} = 600 \text{ V}$, $V_{GE} = \pm 15 \text{ V}$, $R_{Gon} = 5.1 \text{ } \Omega$	$T_{vj} = 25 \text{ }^\circ\text{C}$	0.031		μs
			$T_{vj} = 125 \text{ }^\circ\text{C}$	0.034		
			$T_{vj} = 175 \text{ }^\circ\text{C}$	0.035		
Turn off delay time (inductive load)	t_{doff}	$I_C = 50 \text{ A}$, $V_{CE} = 600 \text{ V}$, $V_{GE} = \pm 15 \text{ V}$, $R_{Goff} = 5.1 \text{ } \Omega$	$T_{vj} = 25 \text{ }^\circ\text{C}$	0.255		μs
			$T_{vj} = 125 \text{ }^\circ\text{C}$	0.340		
			$T_{vj} = 175 \text{ }^\circ\text{C}$	0.382		
Fall time (inductive load)	t_f	$I_C = 50 \text{ A}$, $V_{CE} = 600 \text{ V}$, $V_{GE} = \pm 15 \text{ V}$, $R_{Goff} = 5.1 \text{ } \Omega$	$T_{vj} = 25 \text{ }^\circ\text{C}$	0.107		μs
			$T_{vj} = 125 \text{ }^\circ\text{C}$	0.195		
			$T_{vj} = 175 \text{ }^\circ\text{C}$	0.255		

Table 10 Characteristic Values (continued)

Parameter	Symbol	Note or test condition	Values			Unit
			Min.	Typ.	Max.	
Turn-on energy loss per pulse	E_{on}	$I_C = 50\text{ A},$ $V_{CE} = 600\text{ V},$ $L_\sigma = 35\text{ nH},$ $di/dt = 1200\text{ A}/\mu\text{s}$ ($T_{vj} = 175\text{ °C}$), $V_{GE} = \pm 15\text{ V},$ $R_{Gon} = 5.1\ \Omega$	$T_{vj} = 25\text{ °C}$ $T_{vj} = 125\text{ °C}$ $T_{vj} = 175\text{ °C}$		3.21	mJ
					4.03	
					4.46	
Turn-off energy loss per pulse	E_{off}	$I_C = 50\text{ A},$ $V_{CE} = 600\text{ V},$ $L_\sigma = 35\text{ nH},$ $du/dt = 2900\text{ V}/\mu\text{s}$ ($T_{vj} = 175\text{ °C}$), $V_{GE} = \pm 15\text{ V},$ $R_{Goff} = 5.1\ \Omega$	$T_{vj} = 25\text{ °C}$ $T_{vj} = 125\text{ °C}$ $T_{vj} = 175\text{ °C}$		3.23	mJ
					5.22	
					6.45	
SC data	I_{SC}	$V_{CC} = 800\text{ V},$ $V_{CEmax} = V_{CES} - L_{sCE} * di/dt$	$t_p \leq 8\ \mu\text{s},$ $T_{vj} = 150\text{ °C}$ $t_p \leq 7\ \mu\text{s},$ $T_{vj} = 175\text{ °C}$		190	A
					180	
Thermal resistance, junction to heatsink	R_{thJH}	per IGBT, $\lambda_{grease} = 3.3\text{ W}/(\text{m}^*\text{K})$		0.850		K/W
Temperature under switching conditions	$T_{vj\ op}$			-40	175	°C

Note: $T_{vj\ op} > 150\text{ °C}$ is allowed for operation at overload conditions. For detailed specifications, please refer to AN 2018-14.

6 Diode, Brake-Chopper

Table 11 Maximum Rated Values

Parameter	Symbol	Note or test condition	Values	Unit	
Repetitive peak reverse voltage	V_{RRM}	$T_{vj} = 25\text{ °C}$	1200	V	
Continuous DC forward current	I_F		25	A	
Repetitive peak forward current	I_{FRM}	$t_p = 1\text{ ms}$	50	A	
I^2t - value	I^2t	$V_R = 0\text{ V},$ $t_p = 10\text{ ms}$	$T_{vj} = 125\text{ °C}$	72.5	A^2s
			$T_{vj} = 175\text{ °C}$	63	

Table 12 Characteristic Values

Parameter	Symbol	Note or test condition	Values			Unit
			Min.	Typ.	Max.	
Forward voltage	V_F	$I_F = 25\text{ A}$, $V_{GE} = 0\text{ V}$	$T_{vj} = 25\text{ °C}$	1.83		V
			$T_{vj} = 125\text{ °C}$	1.70		
			$T_{vj} = 175\text{ °C}$	1.63		
Peak reverse recovery current	I_{RM}	$V_R = 600\text{ V}$, $V_{GE} = -15\text{ V}$, $-di_F/dt = 1100\text{ A}/\mu\text{s}$ ($T_{vj} = 175\text{ °C}$)	$T_{vj} = 25\text{ °C}$	27.4		A
			$T_{vj} = 125\text{ °C}$	31.2		
			$T_{vj} = 175\text{ °C}$	34.1		
Recovered charge	Q_r	$V_R = 600\text{ V}$, $V_{GE} = -15\text{ V}$, $-di_F/dt = 1100\text{ A}/\mu\text{s}$ ($T_{vj} = 175\text{ °C}$)	$T_{vj} = 25\text{ °C}$	1.93		μC
			$T_{vj} = 125\text{ °C}$	3.51		
			$T_{vj} = 175\text{ °C}$	4.51		
Reverse recovery energy	E_{rec}	$V_R = 600\text{ V}$, $V_{GE} = -15\text{ V}$, $-di_F/dt = 1100\text{ A}/\mu\text{s}$ ($T_{vj} = 175\text{ °C}$)	$T_{vj} = 25\text{ °C}$	0.74		mJ
			$T_{vj} = 125\text{ °C}$	1.42		
			$T_{vj} = 175\text{ °C}$	1.85		
Thermal resistance, junction to heatsink	R_{thJH}	per diode, $\lambda_{grease} = 3.3\text{ W}/(\text{m}^2\text{K})$		1.86		K/W
Temperature under switching conditions	$T_{vj\text{ op}}$		-40		175	$^{\circ}\text{C}$

Note: $T_{vj\text{ op}} > 150\text{ °C}$ is allowed for operation at overload conditions. For detailed specifications, please refer to AN 2018-14.

7 NTC-Thermistor

Table 13 Characteristic Values

Parameter	Symbol	Note or test condition	Values			Unit
			Min.	Typ.	Max.	
Rated resistance	R_{25}	$T_{NTC} = 25\text{ °C}$		5		k Ω
Deviation of R_{100}	$\Delta R/R$	$T_{NTC} = 100\text{ °C}$, $R_{100} = 493\text{ }\Omega$	-5		5	%
Power dissipation	P_{25}	$T_{NTC} = 25\text{ °C}$			20	mW
B-value	$B_{25/50}$	$R_2 = R_{25} \exp[B_{25/50}(1/T_2 - 1/(298,15\text{ K}))]$		3375		K
B-value	$B_{25/80}$	$R_2 = R_{25} \exp[B_{25/80}(1/T_2 - 1/(298,15\text{ K}))]$		3411		K
B-value	$B_{25/100}$	$R_2 = R_{25} \exp[B_{25/100}(1/T_2 - 1/(298,15\text{ K}))]$		3433		K

Note: Specification according to the valid application note.

8 Characteristics diagrams

output characteristic (typical), IGBT, Inverter

$$I_C = f(V_{CE})$$

$$V_{GE} = 15 \text{ V}$$

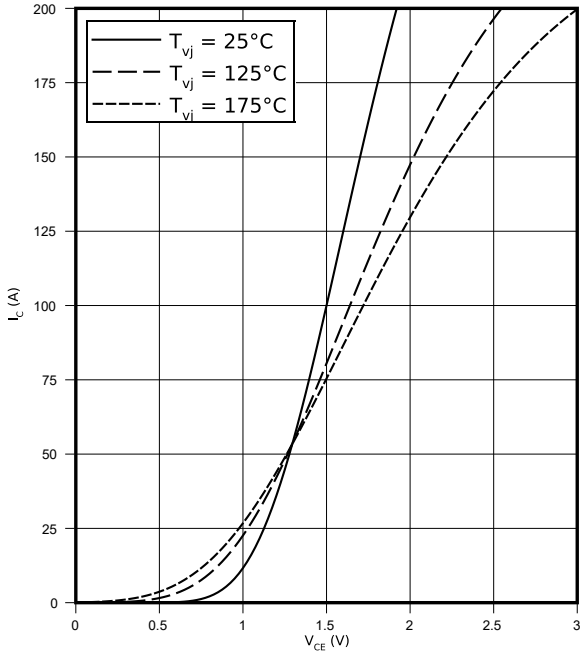

output characteristic (typical), IGBT, Inverter

$$I_C = f(V_{CE})$$

$$T_{vj} = 175 \text{ °C}$$

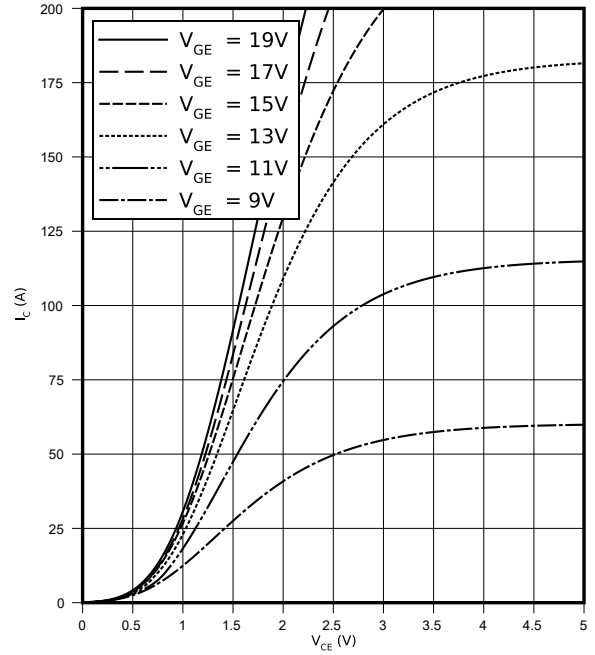

transfer characteristic (typical), IGBT, Inverter

$$I_C = f(V_{GE})$$

$$V_{CE} = 20 \text{ V}$$

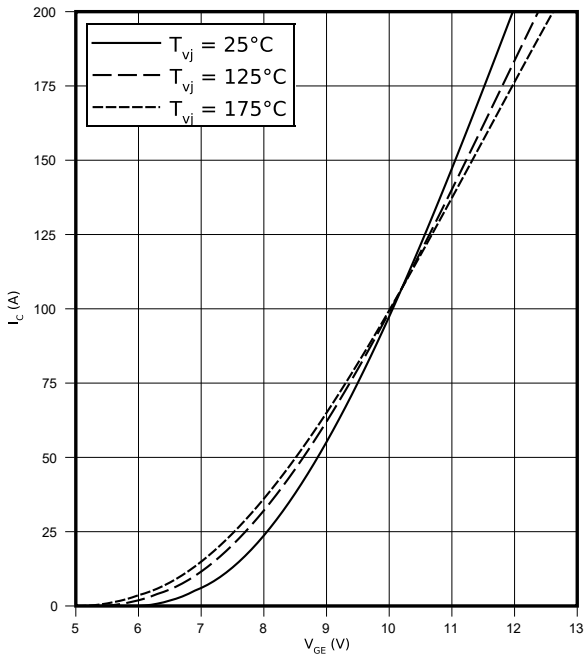

switching losses (typical), IGBT, Inverter

$$E = f(I_C)$$

$$R_{Goff} = 3.3 \text{ } \Omega, R_{Gon} = 3.3 \text{ } \Omega, V_{CE} = 600 \text{ V}, V_{GE} = \pm 15 \text{ V}$$

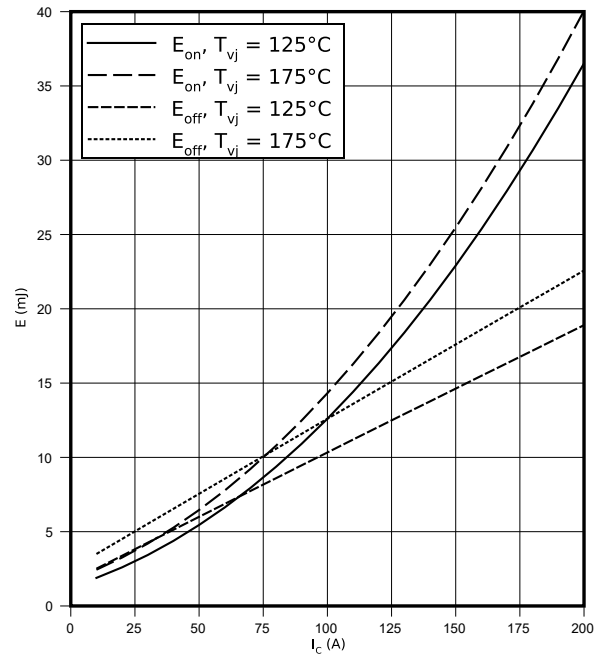

8 Characteristics diagrams

switching losses (typical), IGBT, Inverter

$E = f(R_G)$

$I_C = 100 \text{ A}, V_{CE} = 600 \text{ V}, V_{GE} = \pm 15 \text{ V}$

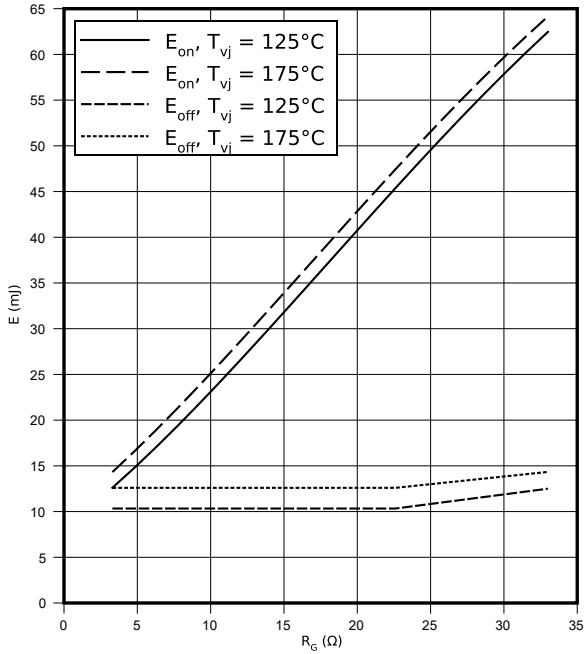

switching times (typical), IGBT, Inverter

$t = f(I_C)$

$R_{Goff} = 3.3 \Omega, R_{Gon} = 3.3 \Omega, V_{CE} = 600 \text{ V}, V_{GE} = \pm 15 \text{ V}, T_{vj} = 175 \text{ °C}$

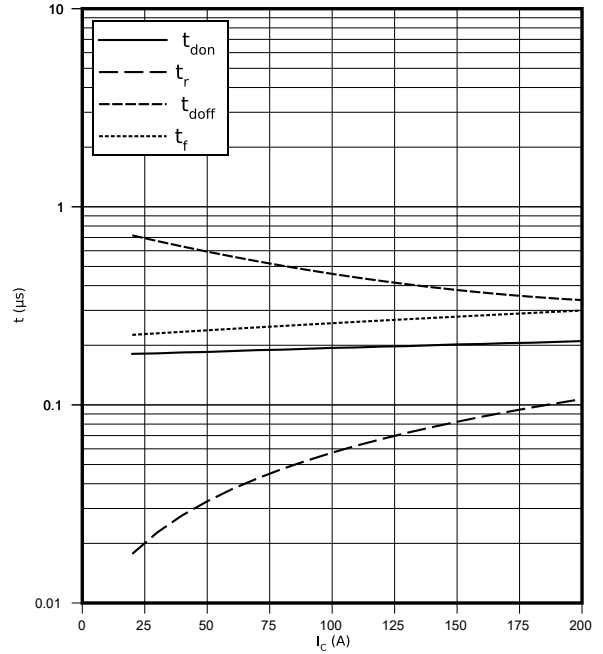

switching times (typical), IGBT, Inverter

$t = f(R_G)$

$I_C = 100 \text{ A}, V_{CE} = 600 \text{ V}, V_{GE} = \pm 15 \text{ V}, T_{vj} = 175 \text{ °C}$

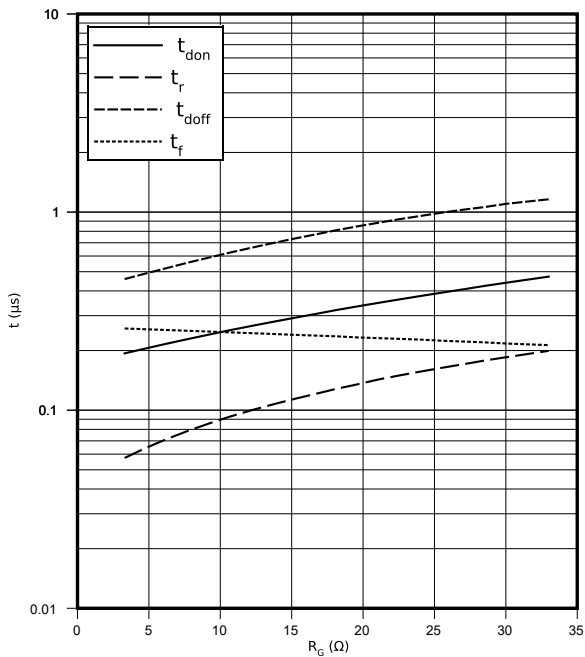

dv/dt (typical), IGBT, Inverter

$dV/dt = f(R_{Gon})$

$I_C = 100 \text{ A}, V_{CE} = 600 \text{ V}, V_{GE} = \pm 15 \text{ V}, T_{vj} = 25 \text{ °C}$

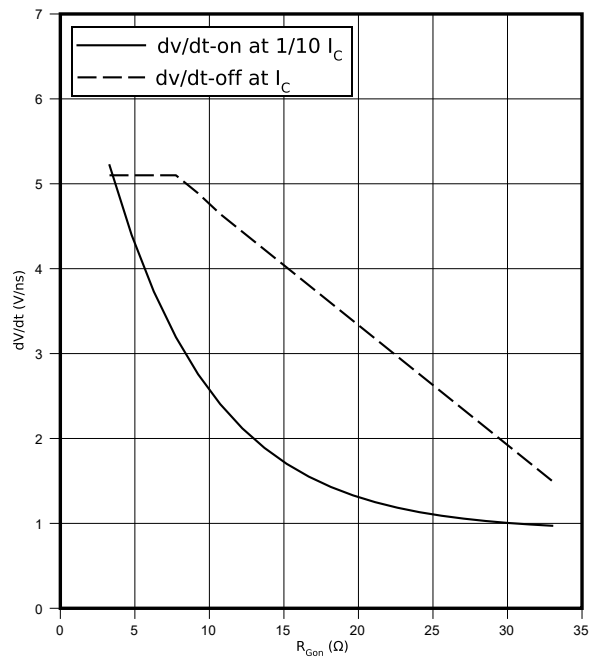

8 Characteristics diagrams

transient thermal impedance , IGBT, Inverter

$Z_{th} = f(t)$

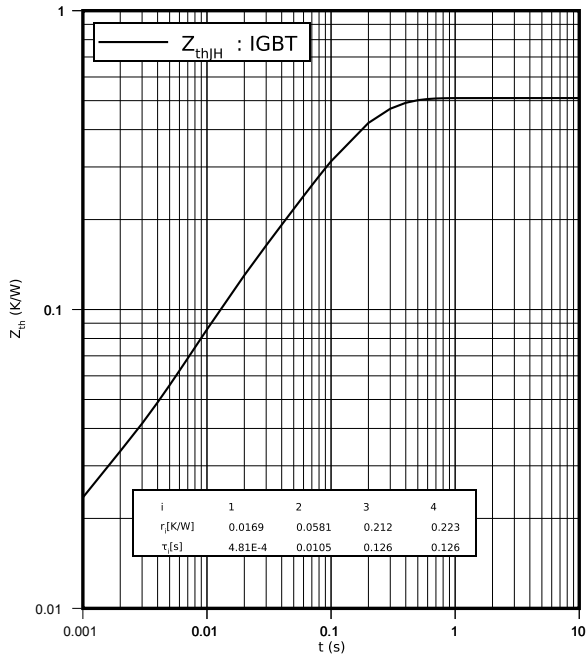

reverse bias safe operating area (RBSOA), IGBT, Inverter

$I_C = f(V_{CE})$

$R_{Goff} = 3.3 \Omega, V_{GE} = \pm 15.0 V, T_{vj} = 175 \text{ }^\circ\text{C}$

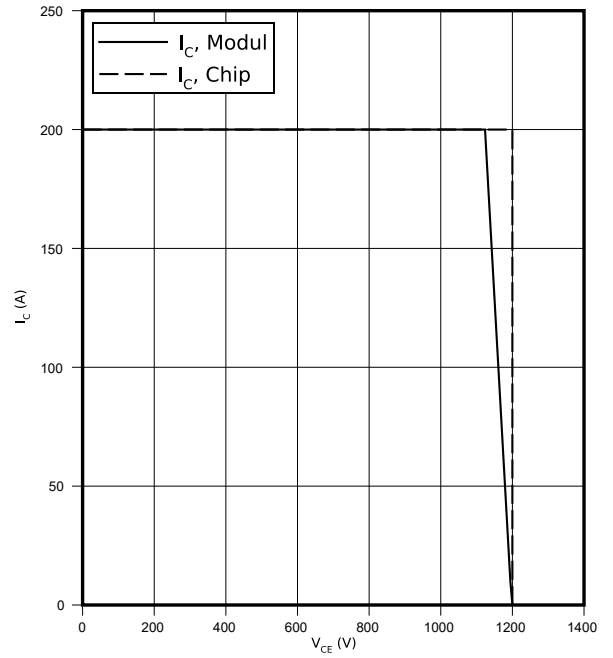

capacity characteristic (typical), IGBT, Inverter

$C = f(V_{CE})$

$f = 100 \text{ kHz}, V_{GE} = 0 V, T_{vj} = 25 \text{ }^\circ\text{C}$

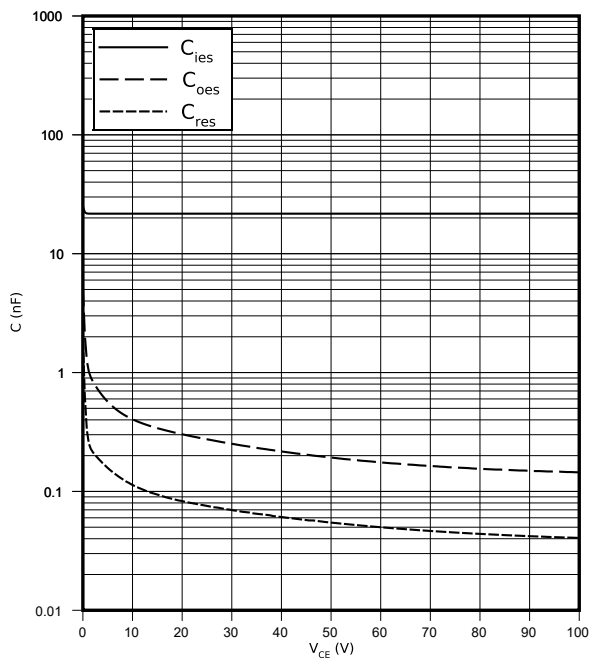

gate charge characteristic (typical), IGBT, Inverter

$V_{GE} = f(Q_G)$

$I_C = 100 A, T_{vj} = 25 \text{ }^\circ\text{C}$

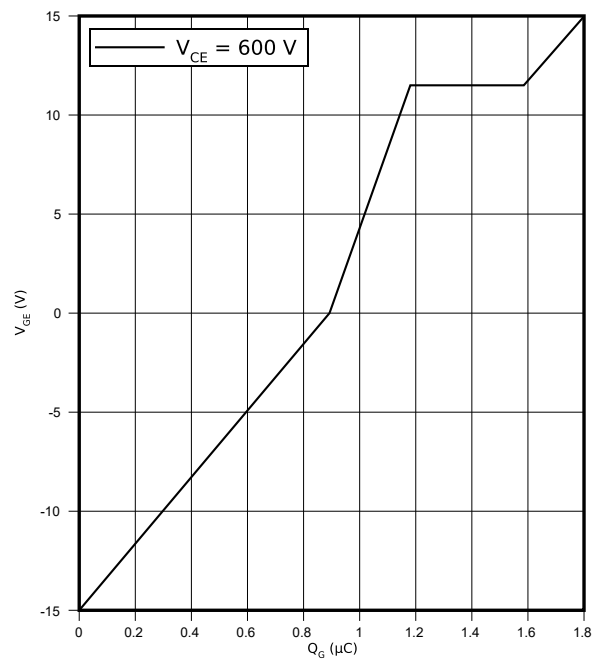

8 Characteristics diagrams

forward characteristic (typical), Diode, Inverter

$I_F = f(V_F)$

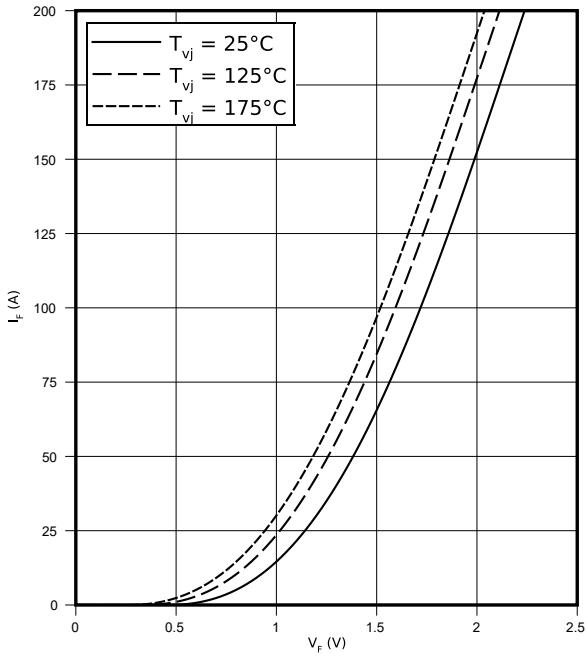

switching losses (typical), Diode, Inverter

$E_{rec} = f(I_F)$

$V_{CE} = 600 \text{ V}, R_{Gon} = R_{Gon}(IGBT)$

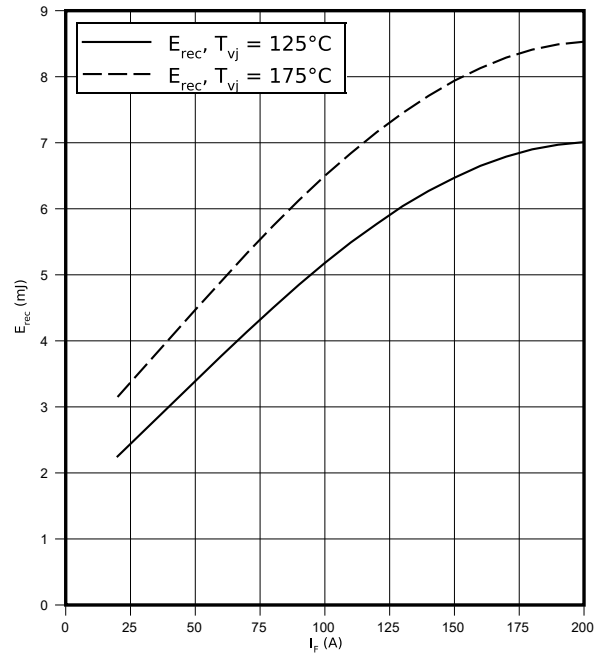

switching losses (typical), Diode, Inverter

$E_{rec} = f(R_G)$

$V_{CE} = 600 \text{ V}, I_F = 100 \text{ A}$

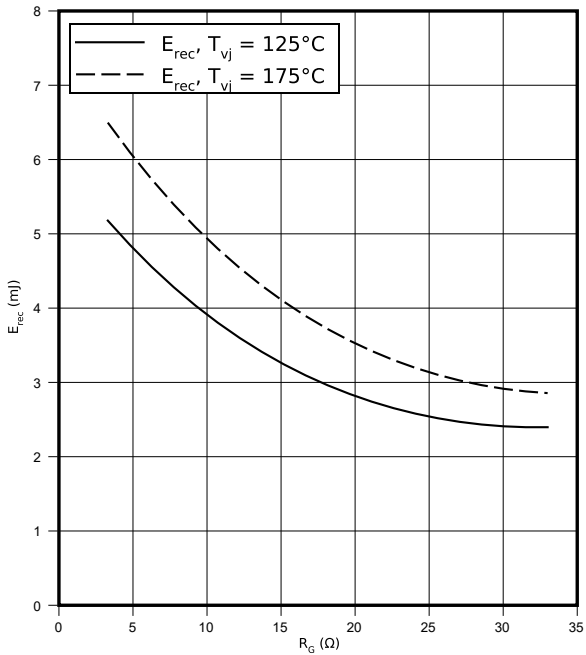

transient thermal impedance, Diode, Inverter

$Z_{th} = f(t)$

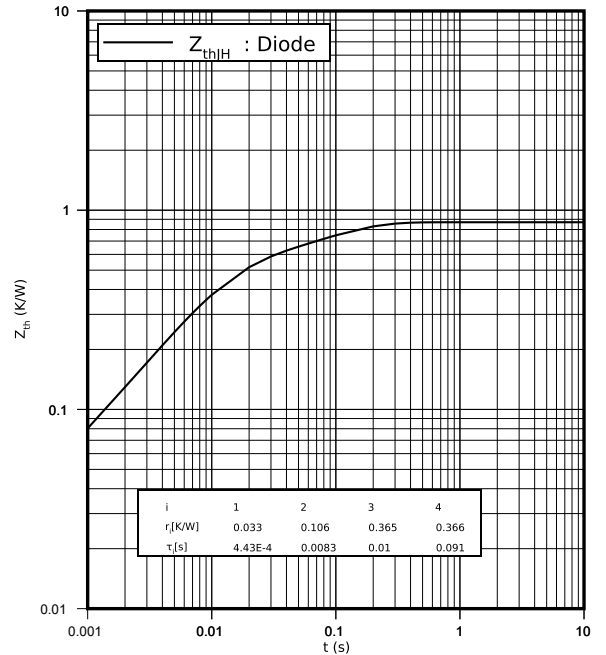

8 Characteristics diagrams

forward characteristic (typical), Diode, Rectifier

$I_F = f(V_F)$

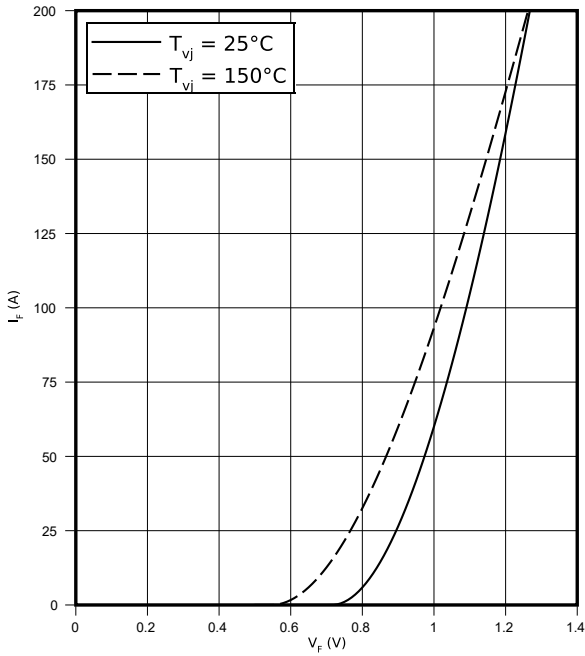

transient thermal impedance, Diode, Rectifier

$Z_{th} = f(t)$

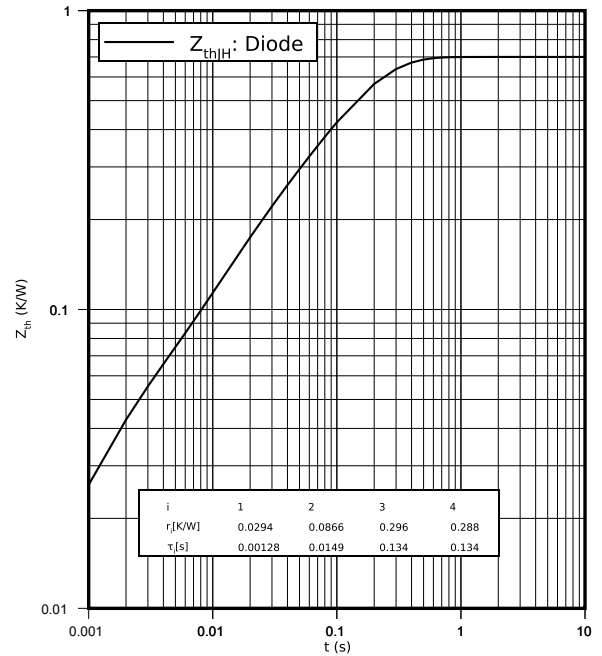

output characteristic (typical), IGBT, Brake-Chopper

$I_C = f(V_{CE})$

$V_{GE} = 15 \text{ V}$

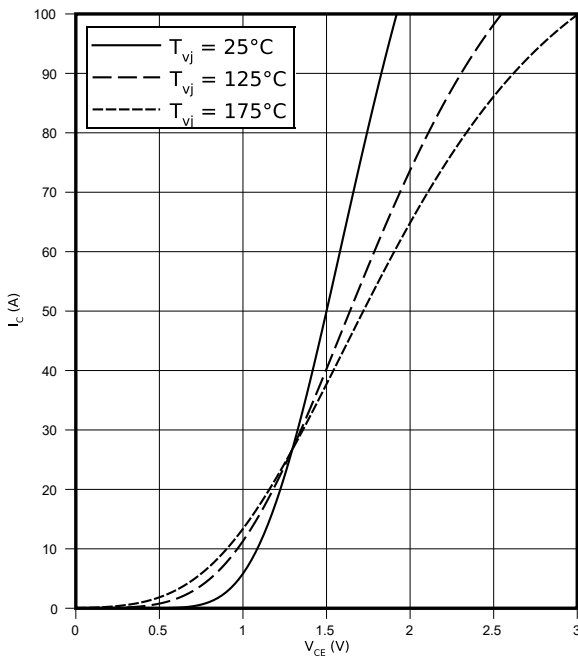

forward characteristic (typical), Diode, Brake-Chopper

$I_F = f(V_F)$

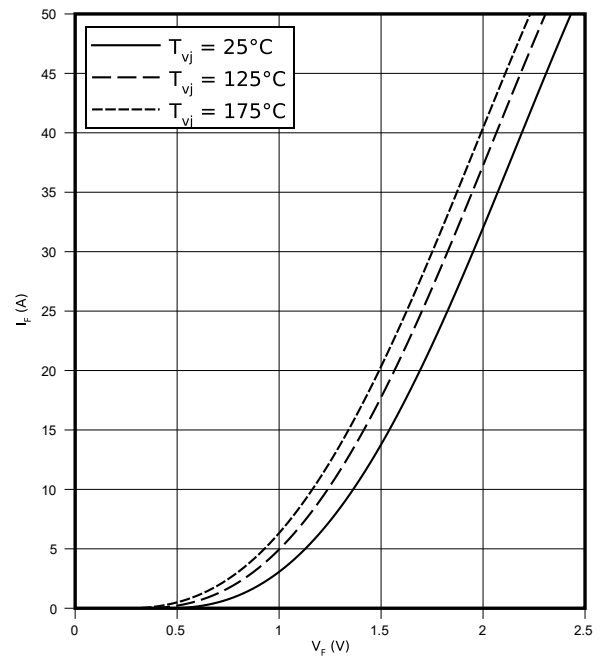

8 Characteristics diagrams

temperature characteristic (typical), NTC-Thermistor

$$R = f(T_{NTC})$$

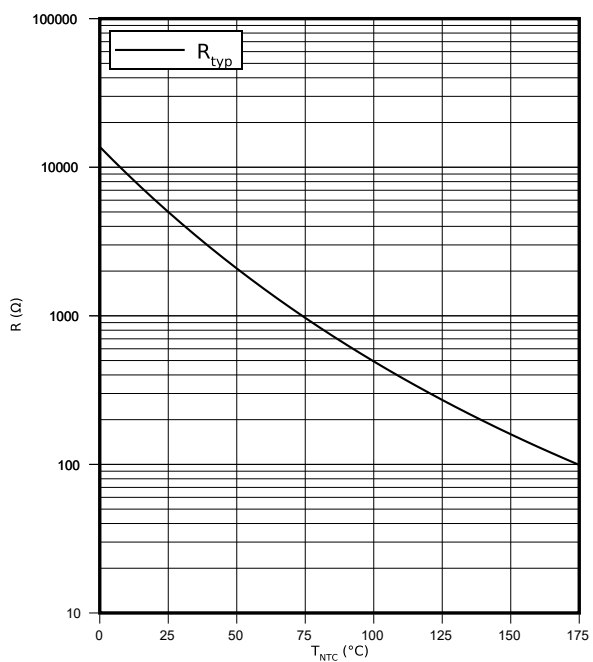

9 Circuit diagram

9 Circuit diagram

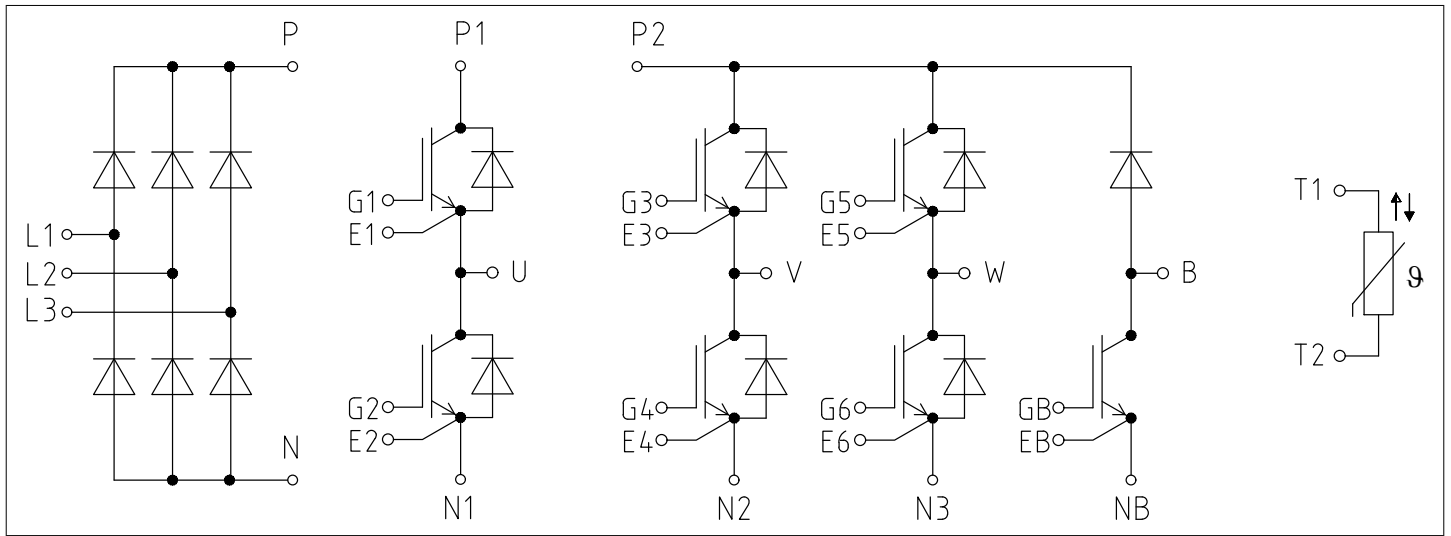

Figure 2

10 Package outlines

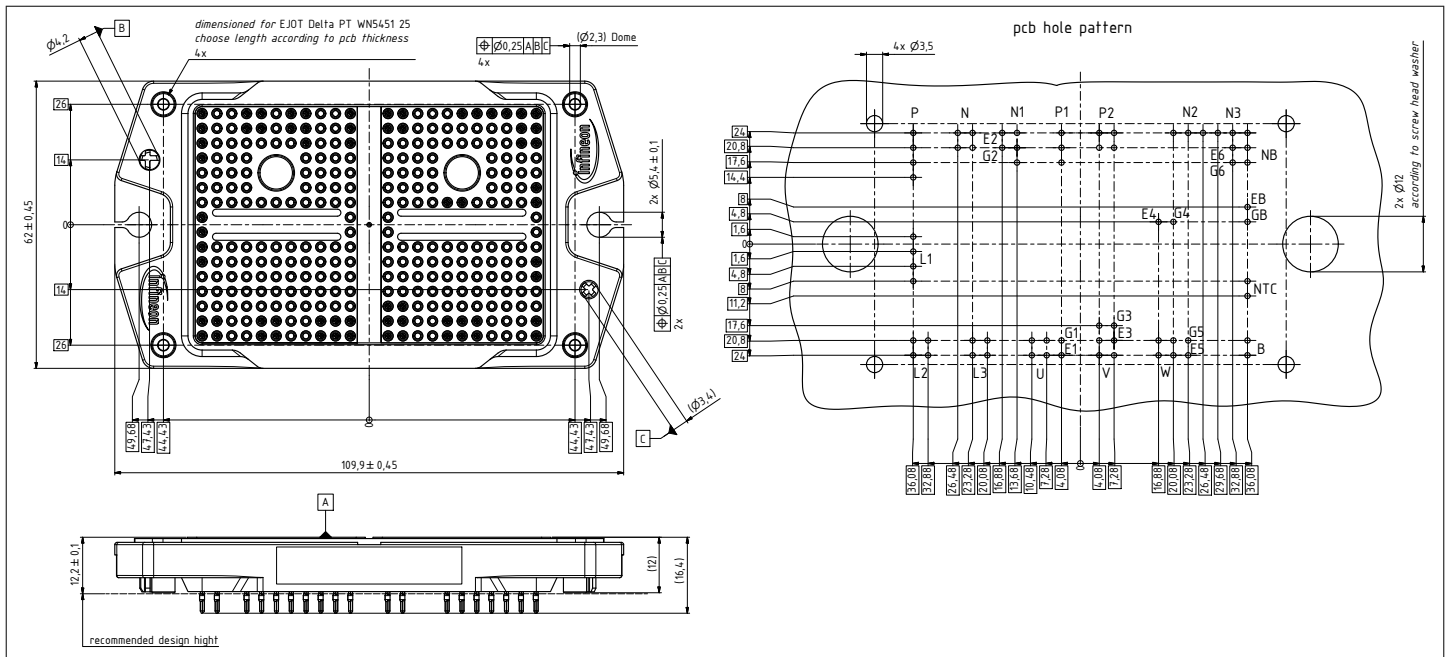

Figure 3

Trademarks

All referenced product or service names and trademarks are the property of their respective owners.

Edition 2020-11-13

Published by

Infineon Technologies AG

81726 Munich, Germany

© 2020 Infineon Technologies AG

All Rights Reserved.

Do you have a question about any aspect of this document?

Email: erratum@infineon.com

Document reference

IFX-

IMPORTANT NOTICE

The information given in this document shall in no event be regarded as a guarantee of conditions or characteristics ("Beschaffheitsgarantie").

With respect to any examples, hints or any typical values stated herein and/or any information regarding the application of the product, Infineon Technologies hereby disclaims any and all warranties and liabilities of any kind, including without limitation warranties of non-infringement of intellectual property rights of any third party.

In addition, any information given in this document is subject to customer's compliance with its obligations stated in this document and any applicable legal requirements, norms and standards concerning customer's products and any use of the product of Infineon Technologies in customer's applications.

The data contained in this document is exclusively intended for technically trained staff. It is the responsibility of customer's technical departments to evaluate the suitability of the product for the intended application and the completeness of the product information given in this document with respect to such application.

Please note that this product is not qualified according to the AEC Q100 or AEC Q101 documents of the Automotive Electronics Council.

WARNINGS

Due to technical requirements products may contain dangerous substances. For information on the types in question please contact your nearest Infineon Technologies office.

Except as otherwise explicitly approved by Infineon Technologies in a written document signed by authorized representatives of Infineon Technologies, Infineon Technologies' products may not be used in any applications where a failure of the product or any consequences of the use thereof can reasonably be expected to result in personal injury.