

[1]Scope

This document explains Soil sensor which can measure EC (Electrical conductivity), Moisture (Volumetric water content; VWC) and Temperature simultaneously in soil and water.

1-1 Specific applications

- Long term monitoring of temperature, moisture, fertilizer in the soil for agriculture.
- Agriculture irrigation system control
- Long term river and pond water condition monitoring
- Aquaculture pond water condition control
- Soil and water environment research

1-2 Unsuitable Application

Applications listed in "Limitation of Applications." in this document.

[2] Part number

| | | |
|------------|-------------------|----------------------------------|
| 2-1 | Part Description | Soil sensor |
| 2-2 | MURATA Part No. | SLT5006 |
| | Customer Part No. | Please fill in your part number. |

[3]Feature

- Simple user interface : three sensors in one package.
- High accuracy moisture sensor : eliminate the effect of saline(ions).
- High performance EC sensor : high accuracy with multi electrodes. it is possible to measure EC of pore water.
- 3D environment measurement : Gathering 3D information with multi placement.
- Rugged and water proof structure : IP68 equivalent. Sensors in strong package.
- Corresponding for wireless system : Low voltage and Low power consumption.
- Variety of interface : UART, RS232, RS485, RS485(MODBUS), SDI-12

[4]Sensing target

①EC sensor

Electrical conductivity depends on contained anion/ cation amount.
(NO₃,NH₄,H₂PO₄,K,Ca,Mg,NaCl etc..)

②Moisture sensor

Measure the electric permittivity, translate to VWC.

③Temperature sensor

Temperature in the soil and water environment.

[5]Sensor Figure

Sensor size: 132.5 x 27 x 16.2 mm \pm 0.2mm

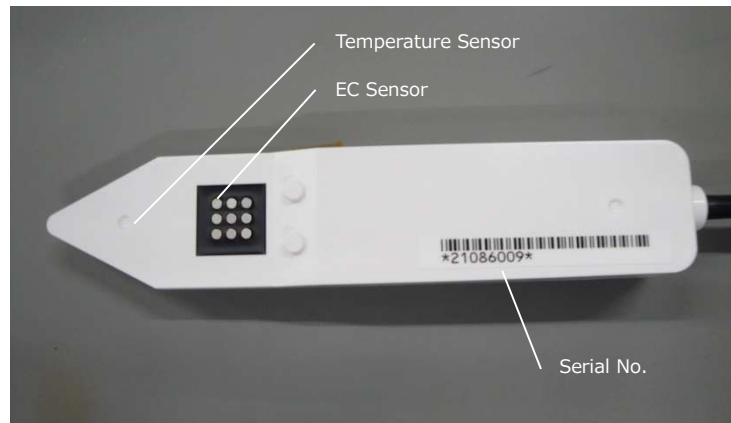

Top side view

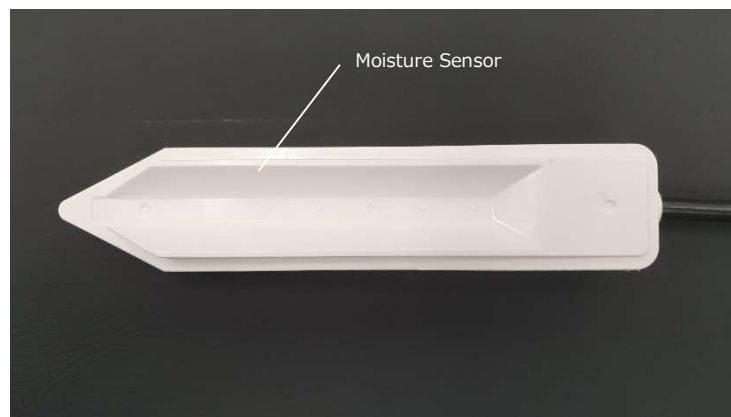

Back side view

[6]Specification

| EC | | Comments |
|------------------|--------------|----------|
| Range[dS/m] | 0—5 | |
| Resolution[dS/m] | 0.001 | |
| Accuracy[%] | ±3 | FS |
| Temperature | | |
| Range[°C] | -20 – 60 | |
| Resolution[°C] | 0.0625 | |
| Accuracy[°C] | ± 1.0±1digit | r.d.g |
| Moisture | | |
| Range[%] | 0—60 | |
| Resolution[%] | 0.1 | |
| Accuracy[%] | ±3 | FS |

| Items | minimum | typical | maximum | Remark |
|---------------------------|--------------|---------|---------|-------------------|
| Power Supply[V] | 3.0 | - | 6.0 | |
| Active Current[mA] | 25 | 30 | 50 | @Read/Write cycle |
| Operating Temperature[°C] | -20 | - | 60 | |
| Measurement Cycle [ms] | Free | | | |
| Enclosure Class | IP68 | | | equivalent |
| Interface | Digital UART | | | |
| Cable length[m] | 3 | | | Standard |

※Remark: In case of freezing condition, moisture sensor value and EC sensor value may vary drastically since the relative dielectric constant changes drastically.

[7]Weathering performance、Mechanical performance

| | item | Method of test | Method of judgement |
|-----|------------------------------|---|---------------------|
| 7-1 | High Temperature bias test | Temperature $70\pm 2^{\circ}\text{C}$ with 3.0V powersupply during 250 hours | Satisfy table1 |
| 7-2 | Low Temperature bias test | Temperatue $-20\pm 2^{\circ}\text{C}$ with 3.0V powersupply During 250 hours | Satisfy table1 |
| 7-3 | High Moisture bias test | Temperature $60\pm 2^{\circ}\text{C}$, Humidity 90~95% with 3.0V powersupply during 250 hours | Satisfy table1 |
| 7-4 | Temperature cycling test | Temperature $-20\pm 2^{\circ}\text{C}$ during 30minites Temperature $60\pm 2^{\circ}\text{C}$ during 30minites 400 cycles | Satisfy table1 |
| 7-5 | Salt spray test | Temperature $35\pm 2^{\circ}\text{C}$ salt concentration $5\pm 1\%$ during 96 hours | Satisfy table1 |
| 7-6 | Vibration test | 10~55Hz/10G max stroke1.5mm 1octave/min 24times/1direction · 3direction sweeptime 5min sweepmethod log | Satisfy table1 |
| 7-7 | Electrostatic Breakdown test | Fig.1 $\pm 2\text{kV}$ $C1=100\text{pF}$, $R1=1.5\text{k}\Omega$ | Satisfy table1 |
| 7-8 | Water proof test | ① Firstly, 8-4 Temperature cycling test, next, underwater with underwater pressure of 1.0m equivalent during 30minites ② Firstly, 8-3 High moisture bias test, next, underwater with underwater pressure of 1.0m equivalent during 30minites | |
| 7-9 | Dust proof test | Field test in the soil grain size under 20um over one year (ref : normal IP6 test, grain size is 75um) | |

Table1. Method of judgement for weathering and mechanical performance

| item | Method of judgement |
|---------|--|
| EC, VWC | Change amount within $\pm 3\%$ for initial value |

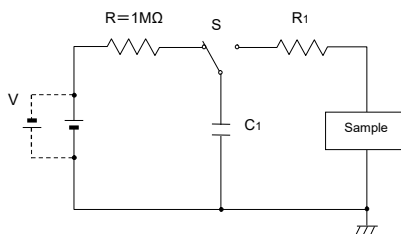

Fig.1

[8]Sensor operation

① EC sensor

EC sensor can measure electrical conductivity of surrounding environments. The basic method is the resistance measurement between two electrodes using alternating voltage. The electrodes need to be protected from corrosion. Therefore, it is important to use the low voltage and the high corrosive-resistant materials.

Normally EC sensor measures the bulk EC(total resistance of soil material, pore water and air). Bulk EC is influenced by water and ions in the soil. Now to know the Pore EC(resistance only in pore water) is important as an indicator of the concentration of fertilizer in the soil. Pore EC is not influenced by volume of water, it is a measurement value which reacts for only volume of ions in the soil.

- Bulk EC is a value suitable for measurement of ions in the water.

- Pore EC is a value suitable for measurement of ions in the soil.

Murata sensor extracts pore EC value by murata original algorithm.

All sensors have the high accuracy by calibration compensated the temperature dependence also before shipment.

Furthermore, EC sensor outputs the raw A-D converter values also, the customer can examine the essential quality for the environments.

② Moisture sensor

Moisture sensor can measure VWC(volumetric water content) of surrounding environments. The basic method is the electric permittivity measurement between two electrodes using alternating voltage with 200MHz. The electric permittivity bears a proportionate to VWC. The electric permittivity at air(no water) becomes close to 1. On the other hand, the electric permittivity at water(100%) becomes close to 80.

High frequency of 200MHz can eliminate the error effect by the content of ions.

All sensors have the high accuracy for the temperature compensation.

Furthermore, moisture sensor outputs the raw A-D converter values also, the customer can examine the essential quality for the environments.

③ Temperature sensor

Temperature sensor utilizes application of diode K factor. It realizes to measure with a high speed and a high accuracy.

[9]Communication specification

Applicable Model

SLT5006

Interface

| | |
|------------------------|---|
| Connection Type | UART |
| Signal | TxD, RxD |
| Baud rate | 9600 |
| Data | 8bit |
| Parity | None |
| Stop | 1 bit |
| Flow Control | None |
| Data Format | Binary |
| Note: | If you want to connect your PC and a soil sensor with a USB port, you may use a USB-Serial Converter cable(TTL-232RG-VIP-WE from FTDI(for UART) etc.) |

Cable

| No. | Color | Input/output | | | | | | Remark |
|-----|--------|-------------------|--------|-----|-----|-------------|------------|------------|
| | | Name | Symbol | IO | | Min | Max | |
| 1 | RED | Supply Voltage | VDD | - | | 3.0 | 6.0 | |
| 2 | BLACK | Ground | VSS | - | | 0.0 | 0.0 | |
| 3 | WHITE | Enable the device | EN | IN | VIH | 0.8 x VDD | VDD | H: Active |
| | | | | | VIL | VSS | 0.2 x VDD | L: Standby |
| 4 | BLUE | Transmitted Data | TxD | OUT | VOH | VINT - 0.45 | - | +2mA |
| | | | | | VOL | - | 0.45 | |
| 5 | YELLOW | Received Data | RxD | IN | VIH | 0.7 x VINT | VINT + 0.3 | |
| | | | | | VIL | VSS - 0.3 | 0.3 x VINT | |
| 6 | GREEN | No connected | NC | - | | - | - | ※1 |
| 7 | ORANGE | No connected | NC | - | | - | - | ※1 |
| 8 | GRAY | - | - | - | | - | - | ※2 |
| - | - | Internal Voltage | VINT | - | | 3.3 | | |

Remarks:

- ※1 : GREEN and ORANGE cables must be floating. Because they are pulled up to VINT(Internal voltage) internally.
- ※2 : GRAY cable and Shield line are connected to GND(VSS) is recommended for the stability of communication.

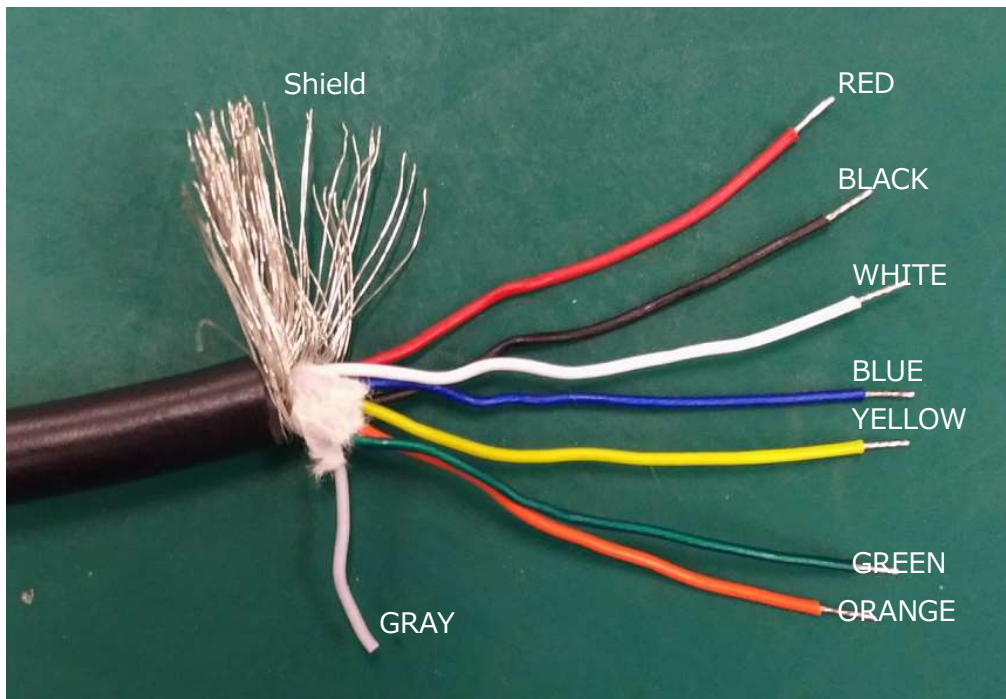

Communication Format

| Name | Size | Description |
|---------------|----------------|--|
| Function Code | 1 byte | Specify "read" or "write" |
| Start Address | 1 byte | Indicate the start address of data for read or write |
| Byte Size | 1 byte | Specify the Byte size of data for read or write |
| Data | Up to 26 bytes | Read data or write data |
| Error Check | 2 bytes | Error Check field based on CRC-16. |

Function Code

| Function Code | Action |
|---------------|--------|
| 0x01 | Read |
| 0x02 | Write |

Operation Method

- ① Start to measure: write "0x01" to SNSR_CTRL register(0x07).
↓
- ② Monitor the state of sensor : read the state("0x00" or "0x01") in SNSR_STATE register(0x08).
0x00 : Still under measuring or not start to measure.
0x01 : finish to measure.
↓
- ③ Read the measurement data : read the data in each registers.
(After finishing the measurement (SNSR_STATE register value="0x01"))

Write(0x02)

Following shows an example of start of measurement

| Message Host device -> Soil Sensor | | | Response Soil Sensor -> Host device | | |
|---------------------------------------|---------------|---------|--|---------------|---------|
| No. | Format | Example | No. | Format | Example |
| 1 | Function Code | 0x02 | 1 | Function Code | 0x02 |
| 2 | Start Address | 0x07 | 2 | Start Address | 0x07 |
| 3 | Byte Size | 0x01 | 3 | Byte Size | 0x01 |
| 4 | Data (1/4) | 0x01 | 4 | Data (1/4) | 0x01 |
| 5 | Data (2/4) | | 5 | Data (2/4) | |
| 6 | Data (3/4) | | 6 | Data (3/4) | |
| 7 | Data (4/4) | | 7 | Data (4/4) | |
| 8 | CRC-16(Upper) | 0x0d | 8 | CRC-16(Upper) | 0x0d |
| 9 | CRC-16(Lower) | 0x70 | 9 | CRC-16(Lower) | 0x70 |

Read (0x01)

Following shows an example of confirmation of measurement finish or not.

| Message Host device -> Soil Sensor | | | Response Soil Sensor -> Host device | | |
|---------------------------------------|---------------|---------|--|---------------|---------|
| No. | Format | Example | No. | Format | Example |
| 1 | Function Code | 0x01 | 1 | Function Code | 0x01 |
| 2 | Start Address | 0x08 | 2 | Start Address | 0x08 |
| 3 | Byte Size | 0x01 | 3 | Byte Size | 0x01 |
| 4 | CRC-16(Upper) | 0x00 | 4 | Data1(Lower) | 0x01 |
| 5 | CRC-16(Lower) | 0xe6 | 5 | Data1(Upper) | |
| | | | 6 | Data2(Lower) | |
| | | | 7 | Data2(Upper) | |
| | | | 8 | CRC-16(Upper) | 0x4a |
| | | | 9 | CRC-16(Lower) | 0x40 |

Error Message

If a host device sends an inappropriate message, it will receive an error message.

| Format | Size |
|-------------------------------------|---------|
| Function Code 0x80 ^[1] | 1 byte |
| Error Code | 1 byte |
| Error Check (CRC-16) | 2 bytes |

[1] MSB of a received function code is set to 1.

| Error Code | Description |
|------------|----------------------------------|
| 0x01 | Illegal Function Code |
| 0x02 | Illegal Start Address |
| 0x03 | Illegal Byte Size |
| 0x04 | Receive buffer overflow |
| 0x05 | CRC-16 error |
| 0x06 | Sensor is measuring |
| 0x10 | Failed to write register |
| 0x20 | Internal I2C communication error |

Register Map

| R/W | Address | Register | 7 | 6 | 5 | 4 | 3 | 2 | 1 | 0 |
|-------|---------|-------------------|-----------------------|---|---|---|-------------------------|------------|-----------|----------|
| Read | 0x00 | FW Version | MAJOR[7:0] | | | | | | | |
| | 0x01 | | MINOR[7:0] | | | | | | | |
| | 0x02 | | REVISION[7:0] | | | | | | | |
| | 0x03 | SERIAL_NO | UID[7:0] | | | | | | | |
| | 0x04 | | UID[15:8] | | | | | | | |
| | 0x05 | | UID[23:16] | | | | | | | |
| | 0x06 | | UID[31:24] | | | | | | | |
| Write | 0x07 | SNSR_CTRL | 0 | 0 | 0 | 0 | 0 | 0 | 0 | MEASRUN |
| Read | 0x08 | SNSR_STATE | 0 | 0 | 0 | 0 | 0 | 0 | 0 | MEASDONE |
| | 0x09 | DDS | DDS[7:0] | | | | | | | |
| | 0x0A | | 0 | 0 | 0 | 0 | DDS[11:8] | | | |
| | 0x0B | ADC_EC | ADC_EC[7:0] | | | | | | | |
| | 0x0C | | 0 | 0 | 0 | 0 | ADC_EC[11:8] | | | |
| | 0x0D | Reserved | Reserved | | | | | | | |
| | 0x0E | Reserved | Reserved | | | | | | | |
| | 0x0F | ADC_PERMITTIVITY | ADC_PERMITTIVITY[7:0] | | | | | | | |
| | 0x10 | | 0 | 0 | 0 | 0 | ADC_PERMITTIVITY [11:8] | | | |
| | 0x11 | ADC_BATTERY | ADC_BATTERY[7:0] | | | | | | | |
| | 0x12 | | 0 | 0 | 0 | 0 | ADC_BATTERY[11:8] | | | |
| | 0x13 | TEMP | TEMP[7:0] | | | | | | | |
| | 0x14 | | 0 | 0 | 0 | 0 | SIGN | TEMP[10:8] | | |
| | 0x15 | EC_BULK | EC_BULK[7:0] | | | | | | | |
| | 0x16 | | EC_BULK[15:8] | | | | | | | |
| | 0x17 | Reserved | Reserved | | | | | | | |
| | 0x18 | Reserved | Reserved | | | | | | | |
| | 0x19 | VWC | VWC[7:0] | | | | | | | |
| | 0x1A | | 0 | 0 | 0 | 0 | 0 | 0 | VWC [9:8] | |
| | 0x1B | Reserved | Reserved | | | | | | | |
| | 0x1C | Reserved | Reserved | | | | | | | |
| | 0x1D | Reserved | Reserved | | | | | | | |
| | 0x1E | Reserved | Reserved | | | | | | | |
| | 0x1F | EC_PORE | EC_PORE[7:0] | | | | | | | |
| | 0x20 | | EC_PORE[15:8] | | | | | | | |
| | 0x21 | Reserved | Reserved | | | | | | | |
| | 0x22 | Reserved | Reserved | | | | | | | |
| | - | 0x23 ~ 0x3C | Access inhibit | | | | | | | |

Parameter description

| Name | Description | Range | | | | | | | | | | | | | | | | | | | | | | | | | | | | | | | | | | | | | | | | | | | | |
|------------------|--|--------------------------------|--|-------------|--|--------|-----|------|--|-------------|----|----|--|-------------|----|---------|--|---|---|---|--|-------------|----|--------|--|-------------|----|---|--|-------------|----|---------|--|---|---|---|--|-------------|----|----------|--|-------------|----|-----|--|-------------------------------------|
| FW Version | Firmware version. Firmware version consists of major version, minor version and revision. | - | | | | | | | | | | | | | | | | | | | | | | | | | | | | | | | | | | | | | | | | | | | | |
| UID | Unique ID. | - | | | | | | | | | | | | | | | | | | | | | | | | | | | | | | | | | | | | | | | | | | | | |
| SNSR_CTRL | Start bit for measuring | - | | | | | | | | | | | | | | | | | | | | | | | | | | | | | | | | | | | | | | | | | | | | |
| SNSR_STATE | State of sensor 0x00: under measuring or not start to measure. 0x01: finish to measure. | - | | | | | | | | | | | | | | | | | | | | | | | | | | | | | | | | | | | | | | | | | | | | |
| DDS | Output of 12-bit Analog-to-Digital (AD) converter : reference clock for EC sensor | 0 ~ 4095 | | | | | | | | | | | | | | | | | | | | | | | | | | | | | | | | | | | | | | | | | | | | |
| ADC_EC | Output of 12-bit Analog-to-Digital converter : EC sensor output. | 0 ~ 4095 | | | | | | | | | | | | | | | | | | | | | | | | | | | | | | | | | | | | | | | | | | | | |
| ADC_BATTERY | Output of 12-bit Analog-to-Digital converter : half of power-supply voltage. | 0 ~ 4095 | | | | | | | | | | | | | | | | | | | | | | | | | | | | | | | | | | | | | | | | | | | | |
| ADC_PERMITTIVITY | Output of 12-bit Analog-to-Digital converter : moisture sensor output. | 0 ~ 4095 | | | | | | | | | | | | | | | | | | | | | | | | | | | | | | | | | | | | | | | | | | | | |
| TEMP | <p>Temperature value: It becomes the output value of [°C] unit by multiplying 0.0625. Data is represented in 2's complement.</p> <p style="text-align: center;">Temperature table</p> <table border="1" style="margin-left: auto; margin-right: auto;"> <thead> <tr> <th colspan="2">TEMP[11:0]</th> <th colspan="2">Temperature</th> </tr> <tr> <th>Binary</th> <th>Hex</th> <th colspan="2">[°C]</th> </tr> </thead> <tbody> <tr> <td>0100_0110_0</td> <td>46</td> <td colspan="2">70</td> </tr> <tr> <td>0100_0101_1</td> <td>45</td> <td colspan="2">69.9375</td> </tr> <tr> <td style="text-align: center;">:</td> <td style="text-align: center;">:</td> <td colspan="2" style="text-align: center;">:</td> </tr> <tr> <td>0000_0000_0</td> <td>00</td> <td colspan="2">0.0625</td> </tr> <tr> <td>0000_0000_0</td> <td>00</td> <td colspan="2">0</td> </tr> <tr> <td>1111_1111_1</td> <td>FF</td> <td colspan="2">-0.0625</td> </tr> <tr> <td style="text-align: center;">:</td> <td style="text-align: center;">:</td> <td colspan="2" style="text-align: center;">:</td> </tr> <tr> <td>1110_1100_0</td> <td>EC</td> <td colspan="2">-19.9475</td> </tr> <tr> <td>1110_1100_0</td> <td>EC</td> <td colspan="2">-20</td> </tr> </tbody> </table> | TEMP[11:0] | | Temperature | | Binary | Hex | [°C] | | 0100_0110_0 | 46 | 70 | | 0100_0101_1 | 45 | 69.9375 | | : | : | : | | 0000_0000_0 | 00 | 0.0625 | | 0000_0000_0 | 00 | 0 | | 1111_1111_1 | FF | -0.0625 | | : | : | : | | 1110_1100_0 | EC | -19.9475 | | 1110_1100_0 | EC | -20 | | -2048 ~ 2047 (-128 ~ 127.9375°C) |
| TEMP[11:0] | | Temperature | | | | | | | | | | | | | | | | | | | | | | | | | | | | | | | | | | | | | | | | | | | | |
| Binary | Hex | [°C] | | | | | | | | | | | | | | | | | | | | | | | | | | | | | | | | | | | | | | | | | | | | |
| 0100_0110_0 | 46 | 70 | | | | | | | | | | | | | | | | | | | | | | | | | | | | | | | | | | | | | | | | | | | | |
| 0100_0101_1 | 45 | 69.9375 | | | | | | | | | | | | | | | | | | | | | | | | | | | | | | | | | | | | | | | | | | | | |
| : | : | : | | | | | | | | | | | | | | | | | | | | | | | | | | | | | | | | | | | | | | | | | | | | |
| 0000_0000_0 | 00 | 0.0625 | | | | | | | | | | | | | | | | | | | | | | | | | | | | | | | | | | | | | | | | | | | | |
| 0000_0000_0 | 00 | 0 | | | | | | | | | | | | | | | | | | | | | | | | | | | | | | | | | | | | | | | | | | | | |
| 1111_1111_1 | FF | -0.0625 | | | | | | | | | | | | | | | | | | | | | | | | | | | | | | | | | | | | | | | | | | | | |
| : | : | : | | | | | | | | | | | | | | | | | | | | | | | | | | | | | | | | | | | | | | | | | | | | |
| 1110_1100_0 | EC | -19.9475 | | | | | | | | | | | | | | | | | | | | | | | | | | | | | | | | | | | | | | | | | | | | |
| 1110_1100_0 | EC | -20 | | | | | | | | | | | | | | | | | | | | | | | | | | | | | | | | | | | | | | | | | | | | |
| EC_BULK | <p>Bulk EC value: It is a value suitable for measurement of ions in the water. It becomes the output value of [dS/m] unit by multiplying 0.001.</p> | 0 ~ 65535 (0 ~ 65.535 dS/m) | | | | | | | | | | | | | | | | | | | | | | | | | | | | | | | | | | | | | | | | | | | | |
| VWC | <p>VWC(Volumetric Water Content) value: It becomes the output value of [%] unit by multiplying 0.1.</p> | 0 ~ 1000 (0 ~ 100.0 %) | | | | | | | | | | | | | | | | | | | | | | | | | | | | | | | | | | | | | | | | | | | | |
| EC_PORE | <p>Pore EC value: It is a value suitable for measurement of ions in the soil. It becomes the output value of [dS/m] unit by multiplying 0.001.</p> | 0 ~ 65535 (0 ~ 65.535 dS/m) | | | | | | | | | | | | | | | | | | | | | | | | | | | | | | | | | | | | | | | | | | | | |

CRC-16

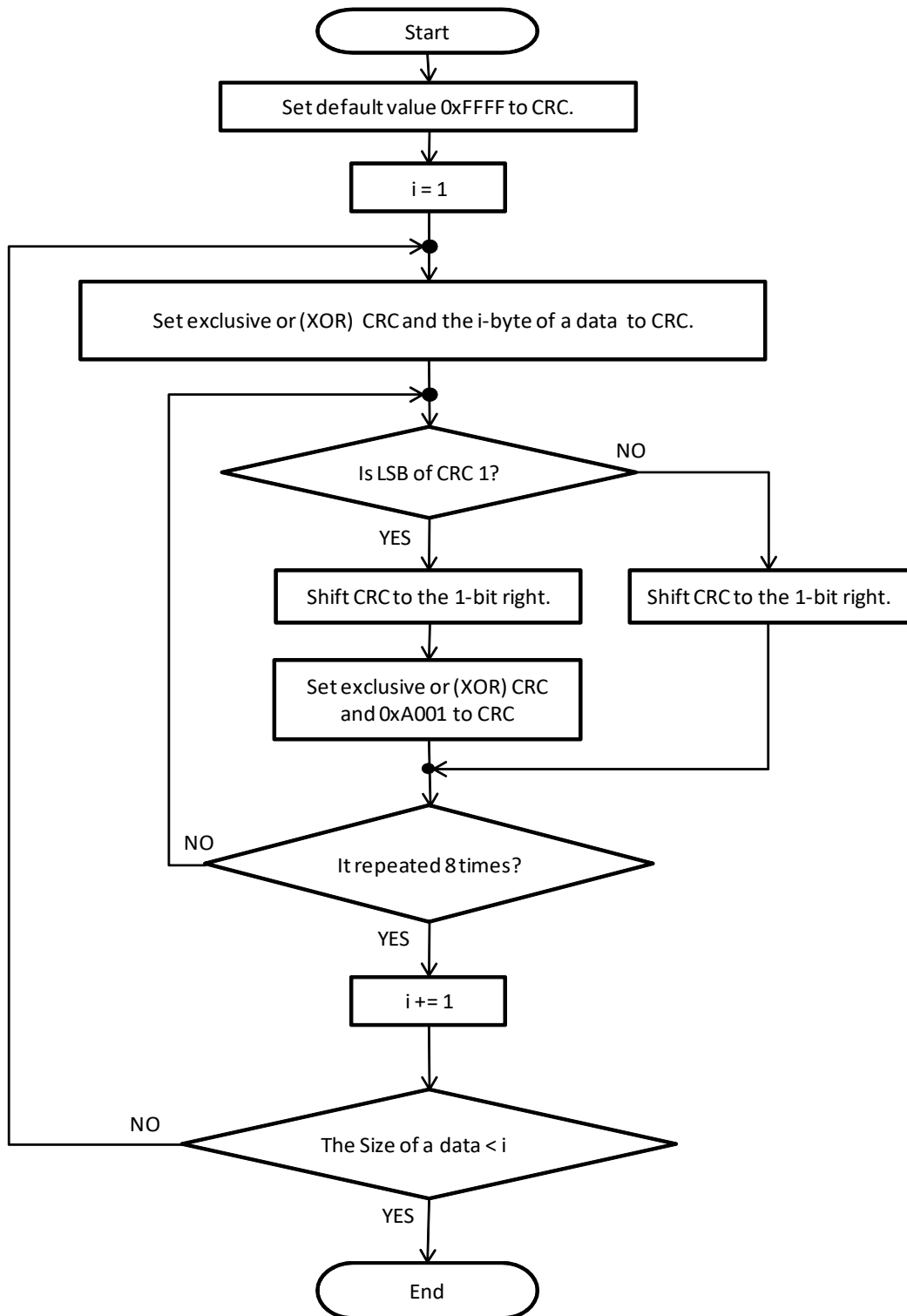

CRC-16 (Program)

```
USHORT CRC16(int size, BYTE* data)
{
    USHORT cr = 0xFFFF;

    for(int i = 0; i < size; i++)
    {
        cr = cr ^ data[i];

        for(int j = 0; j < 8; j++)
        {
            if((cr & 0x0001) == 0x0001)
            {
                cr >>= 1;
                cr ^= 0xA001;
            }
            else
            {
                cr >>= 1;
            }
        }
    }

    return cr;
}
```

Sample code, Timing chart

- ① Start to measure: write "0x01" to SNSR_CTRL register(0x07).
- ② Monitor the state of sensor : read the state("0x00" or "0x01") in SNSR_STATE register(0x08).
 0x00 : Still under measuring or not start to measure.
 0x01 : finish to measure.
- ③ Read the measurement data : read the data in each registers.
 (After finishing the measurement (SNSR_STATE register value="0x01"))

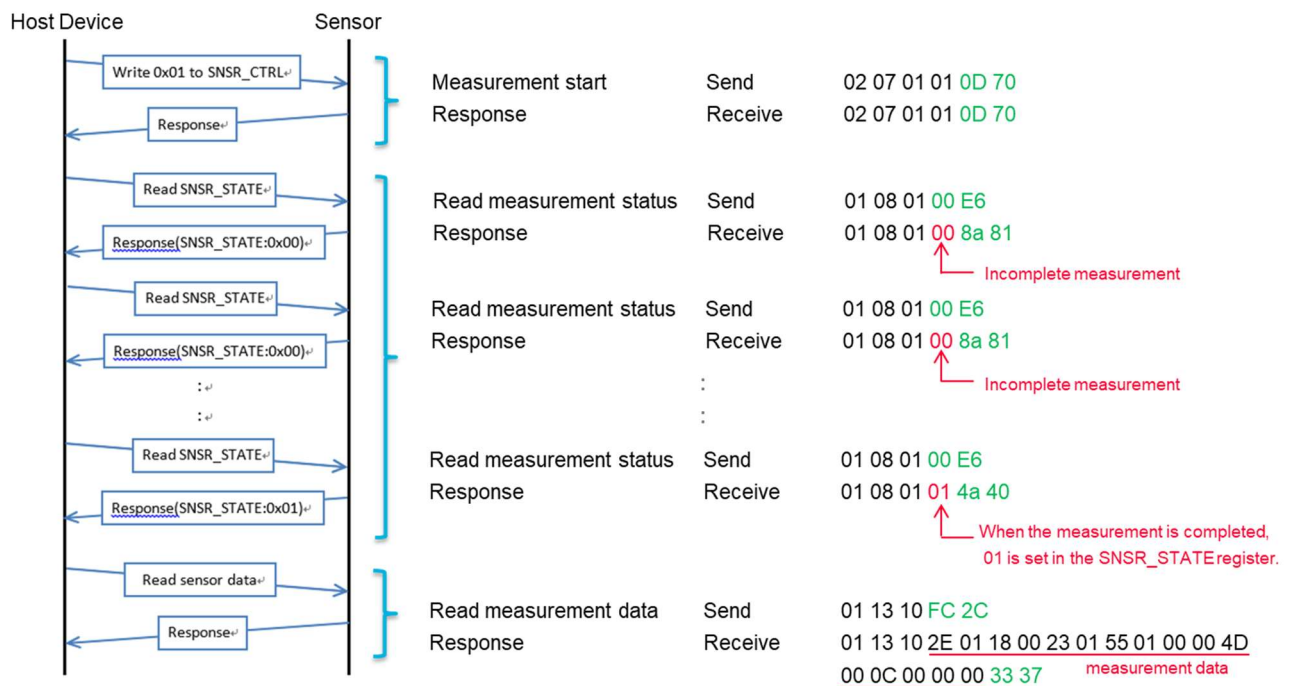

※Green character is CRC-16 code. Please calculate according to the CRC-16 program described in the specification and use it for transmission and error check at reception.

- Command to read measurement data of ①~⑧



- How to read the measurement data

- ① TEMP : 2E 01 ⇒ 0x012E ⇒ 302d×0.0625 ⇒ 18.875[°C]
- ② EC_BULK : 18 00 ⇒ 0x0018 ⇒ 24d×0.001 ⇒ 0.024[dS/m]
- ③ DummyData : 23 01
- ④ VWC : 55 01 ⇒ 0x0155 ⇒ 341d×0.1 ⇒ 34.1[%]
- ⑤ DummyData : 00 00
- ⑥ DummyData : 4D 00
- ⑦ EC_PORE : 0C 00 ⇒ 0x000C ⇒ 12d×0.001 ⇒ 0.012[dS/m]
- ⑧ DummyData : 00 00

Power ON timing

* Cable length 3m

Timing case 1: VDD "High" -> EN "High"

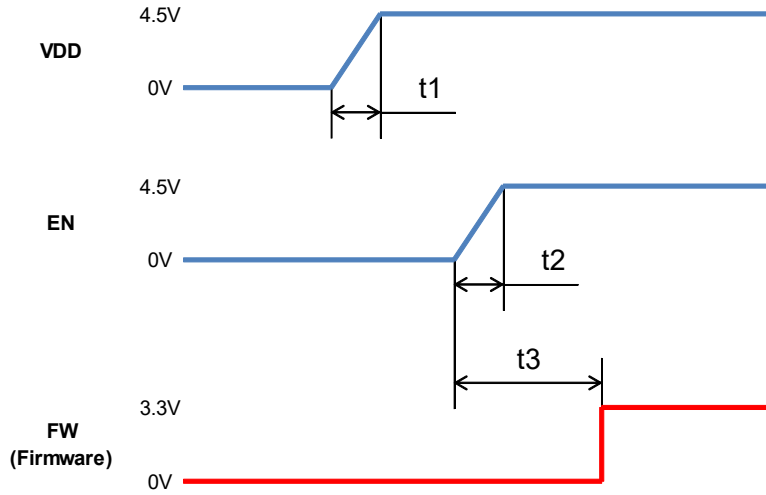

| items | symbol | Typ | unit |
|------------------------------|--------|-----|------|
| VDD rise time | t1 | 3 | ms |
| EN rise time | t2 | 2.2 | ms |
| EN "start" ~ FW "start" time | t3 | 11 | ms |

Timing case 2: VDD and EN "High" at same time

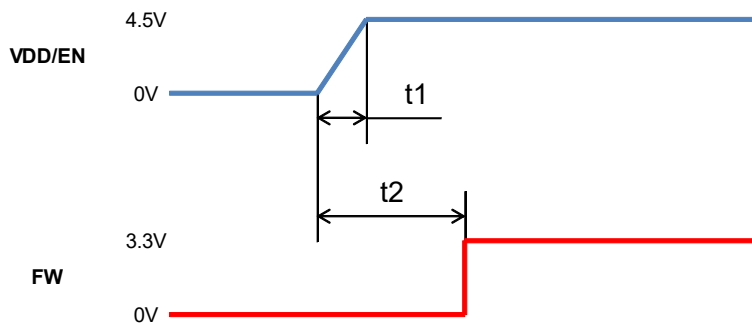

| items | symbol | Typ | unit |
|----------------------------------|--------|-----|------|
| VDD/EN rise time at same time | t1 | 3 | ms |
| VDD/EN "start" ~ FW "start" time | t2 | 11 | ms |

Power off timing

Timing case 1: EN "Low" -> VDD "Low"

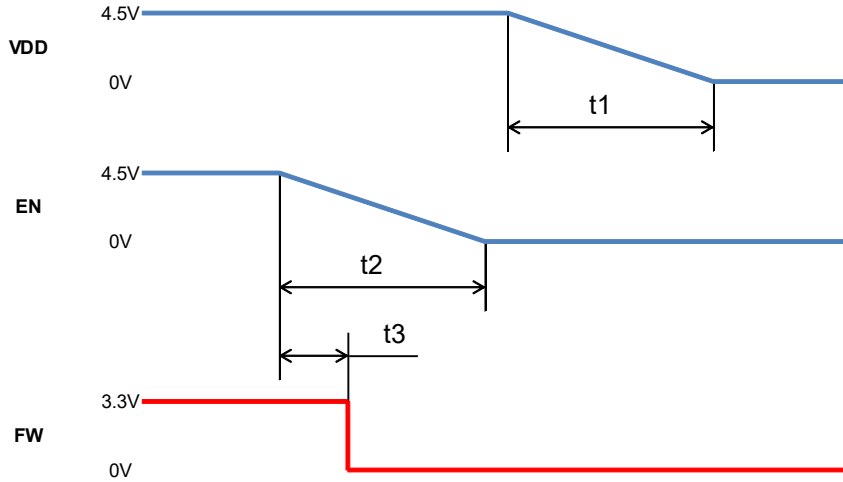

| items | symbol | Typ | unit |
|----------------------------------|--------|-----|------|
| VDD fall time | t1 | 110 | ms |
| EN fall time | t2 | 103 | ms |
| EN "fall start" ~ FW "stop" time | t3 | 69 | ms |

Timing case 2: VDD and EN "Low" at same time

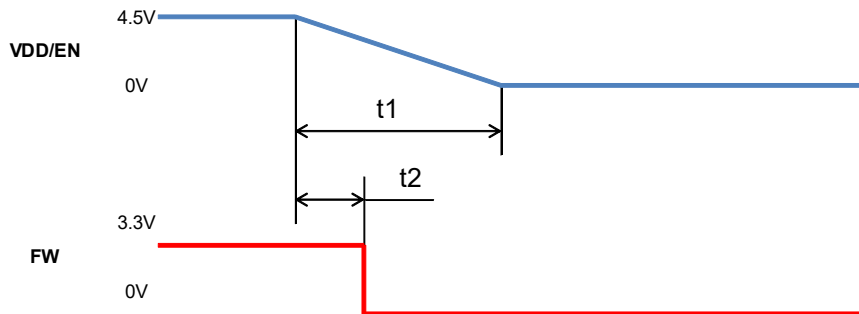

| items | symbol | Typ | unit |
|--------------------------------------|--------|-----|------|
| VDD/EN fall time at same time | t1 | 70 | ms |
| VDD/EN "fall start" ~ FW "stop" time | t2 | 52 | ms |

UART communication

| | | |
|----------------------------------|--------------|---------|
| UART communication specification | Baud rate | 9600bps |
| | Data size | 8bit |
| | Parity | none |
| | Stop bit | 1bit |
| | Flow control | none |

TX/RX looked from sensor side

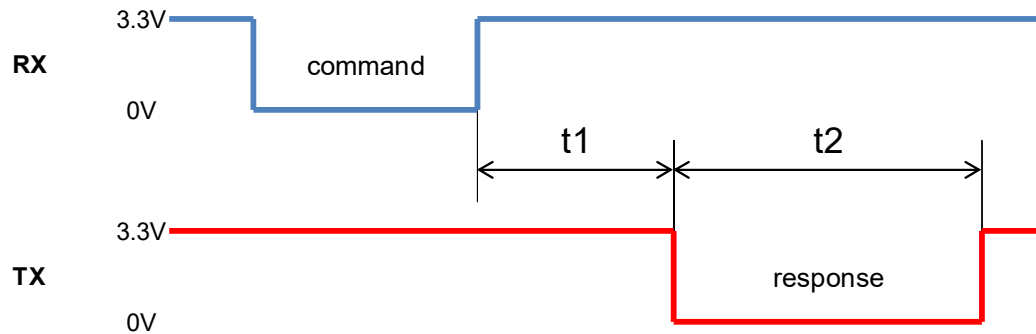

| items | symbol | MAX | unit |
|--------------------|--------|-----|------|
| response wait time | t1 | 5 | ms |
| response time | t2 | 33 | ms ※ |

※Response as 26 data were read from Register0x09 to Register0x22

Measurement time

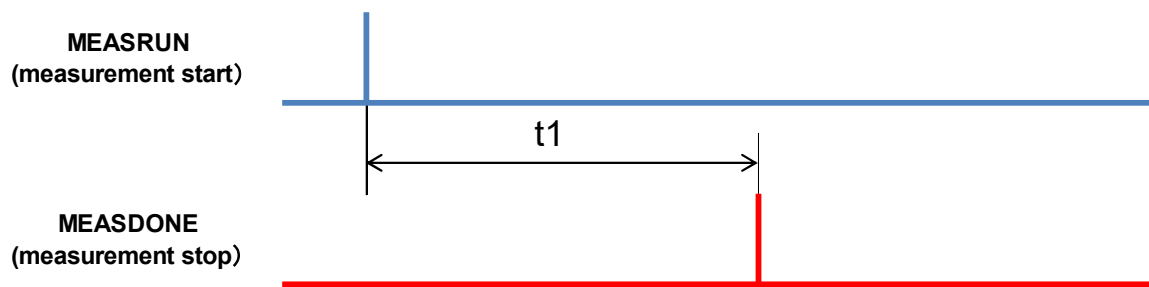

| items | symbol | MAX | unit |
|------------------|--------|-----|------|
| measurement time | t1 | 4 | s |

[10] Product label

The serial number is printed on the surface of the product body.

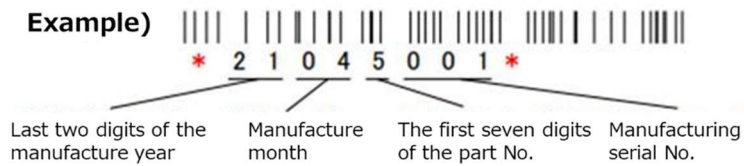

[11] Packing

After packing the products one by one with package cushioning, put them in a bag. Furthermore, it is packed in one of three types of boxes according to the quantity as follows.

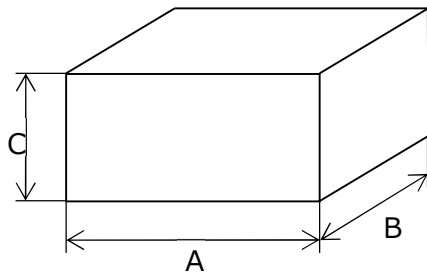

| Box type | Size(Typical mm) | | | Maximum quantity |
|----------|------------------|-----|-----|------------------|
| | A | B | C | |
| 40 号 | 336 | 263 | 227 | 15 pcs. |
| 10 号 | 267 | 170 | 120 | 5 pcs. |

[12] Warranty

12-1. Warranty period

The warranty period is one year after delivery.

12-2. Warranty details

The sensor will be exchanged free of charge in case of a malfunction occurred under the normal use that has followed the specifications and cautions of this document.

※The warranty is only covered by the contents in the specification that meet our measurement standard.

12-3. Disclaimer

Murata shall be under no liability in respect of any fault and damage as follows.

- (1) Misuse, improper handling, improper repair, and improper alteration.
(Including failure to use normally in accordance with handling method and caution described in this document.)
- (2) Improper handling such as dropping or impact on transportation or moving.
- (3) Fire, earthquake, lightning surge, or other natural disaster.
- (4) Gas damage (hydrogen sulfide gas, etc.).
- (5) Non-specified power connection and erroneous connection.
- (6) Cause from any other devices which is connected to the system.
- (7) Excessive stress, dent, scratch
- (8) Chemicals, organic solvents
- (9) Biological factors

[13] ⚠Caution

13-1. Limitation of Applications

The products listed in the document (hereinafter the product(s) is called as the “Product(s)”) are designed and manufactured for applications specified in the document. (hereinafter called as the “Specific Application”).

We shall not warrant anything in connection with the Products including fitness, performance, adequateness, safety, or quality, in the case of applications listed in from (1) to (11) written at the end of this precautions, which may generally require high performance, function, quality, management of production or safety. Therefore, the Product shall be applied in compliance with the specific application. WE DISCLAIM ANY LOSS AND DAMAGES ARISING FROM OR IN CONNECTION WITH THE PRODUCTS INCLUDING BUT NOT LIMITED TO THE CASE SUCH LOSS AND DAMAGES CAUSED BY THE UNEXPECTED ACCIDENT, IN EVENT THAT (i) THE PRODUCT IS APPLIED FOR THE PURPOSE WHICH IS NOT SPECIFIED AS THE SPECIFIC APPLICATION FOR THE PRODUCT, AND/OR (ii) THE PRODUCT IS APPLIED FOR ANY FOLLOWING APPLICATION PURPOSES FROM (1) TO (11) (EXCEPT THAT SUCH APPLICATION PURPOSE IS UNAMBIGUOUSLY SPECIFIED AS SPECIFIC APPLICATION FOR THE PRODUCT IN OUR CATALOG SPECIFICATION FORMS, DATASHEETS, OR OTHER DOCUMENTS OFFICIALLY ISSUED BY US*).

- (1) Aircraft equipment
- (2) Aerospace equipment
- (3) Undersea equipment
- (4) Power plant control equipment
- (5) Medical equipment
- (6) Transportation equipment
- (7) Traffic control equipment
- (8) Disaster prevention/security equipment
- (9) Industrial data-processing equipment
- (10) Combustion/explosion control equipment
- (11) Equipment with complexity and/or required reliability equivalent to the applications listed in the above.

For exploring information of the Products which will be compatible with the particular purpose other than those specified in the document, please contact our sales offices, distribution agents, or trading companies with which you make a deal, or via our web contact form.

Contact form: <https://www.murata.com/contactform>

*We may design and manufacture particular Products for applications listed in (1) to (11). Provided that, in such case we shall unambiguously specify such Specific Application in the document without any exception. Therefore, any other documents and/or performances, whether exist or non-exist, shall not be deemed as the evidence to imply that we accept the applications listed in (1) to (11).

13-2. Addition of fail-safe function

To avoid of unprecedented failure caused by this product, please include appropriate fail-safe protection function to the overall system.

[14] Caution of storage

14-1. Temperature -20~+60°C.

Please store it in the room without the sudden temperature change.

14-2. A deterioration in the quality of product is caused when kept of chemical atmospheres such as acid, alkali, salt, organic gas, sulfur.

Please store it avoiding the chemical atmosphere.

14-3. Please store it avoiding direct sunlight, heat, vibration.

14-4. A failure is caused by the dropping of product.

Please handle and store it with the state not to drop easily.

[15] Request

1. When using the product, please be sure to evaluate it in the condition of being mounted on your product.
2. Please do not use this product deviating from the description in this delivery specification.

(Appendix)

Handling method

Recommended way of setting up

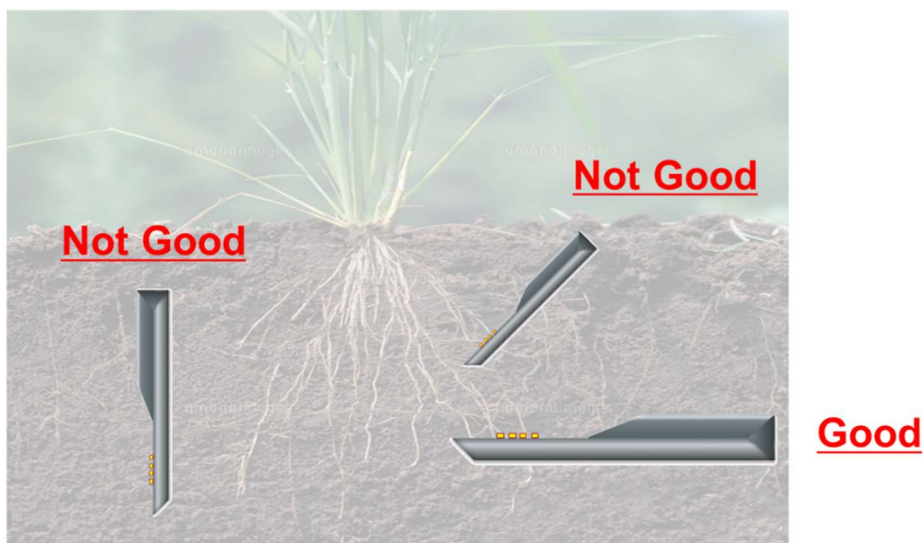

Sensing/detecting area

The effective sensing area is 7cm from the bottom, left and right of the sensor for VWC and EC_pore measurement.

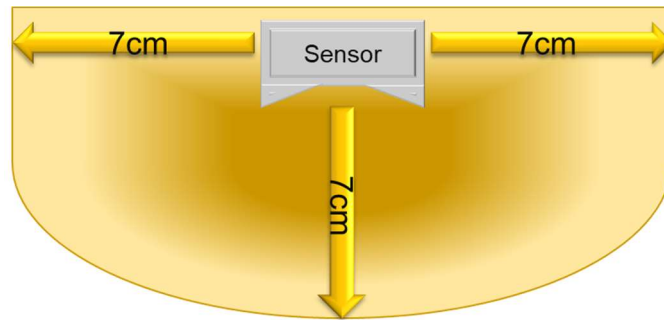

Recommended way of setting up ①

- ✓ Set EC sensor side (the side you can see 9 electrodes) upward.
- ✓ Put the sensor in the target ground depth (from the ground level to EC sensor surface)



① Dig a hole in the ground



② put fine soil through a sieve



③ Put sensor with sticking to soil, then move right/left for more close sticking



④ By fixing sensor, put more fine soil



⑤ After soil covering the whole sensor, add more soil with surroundings

Recommended way of setting up ②

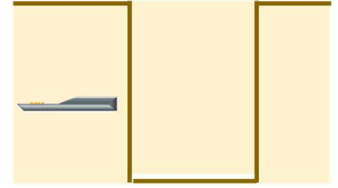
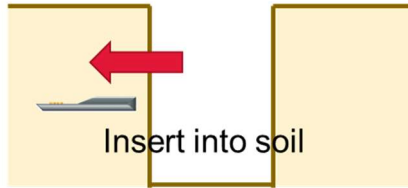

① Dig a hole in the ground

② Insert into soil from hole section
Please insert the whole sensor in the soil

③ Bury the hole

Handling of setting and removal

When you set it up in the soil, please push it from the two yellow mark positions. Please do not apply force to the electrical cable, and please do not touch the electrode directly. When you remove it from the soil, please do not pull the electrical cable.

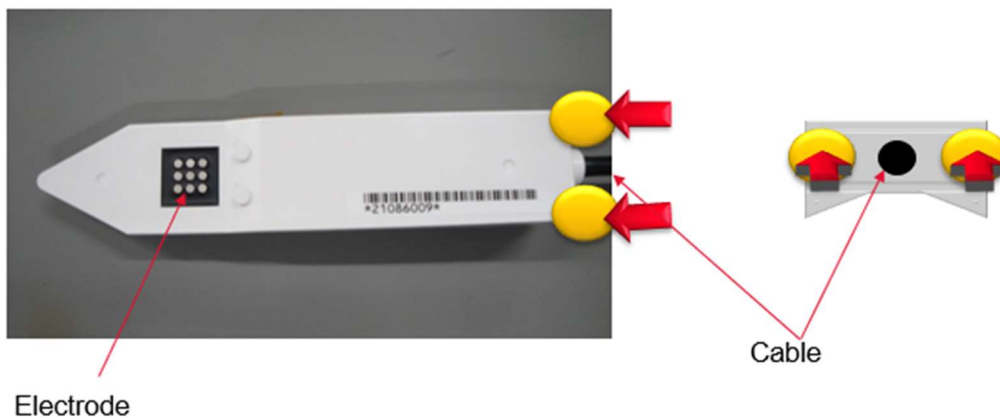

Storage method after removal

Please store it after washing with water.

If needed, please use a neutral detergent for tableware.

Please wash it with soft cloth, do not use any hard metal on electrodes.

After that, please dry the sensor completely before storage, and store it avoiding direct sunlight.

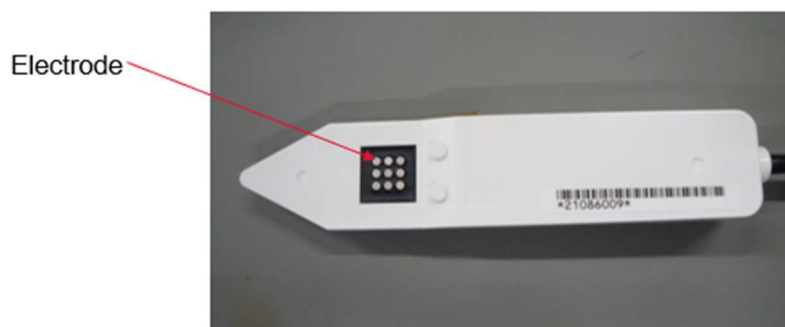

Precaution for use

Please do not pull out the connector with the sensor power on.

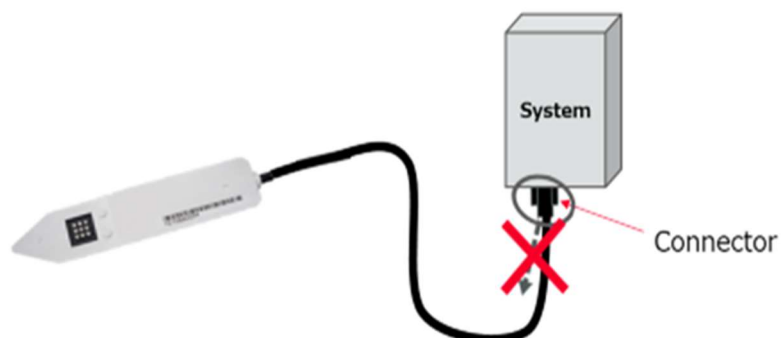

Revision history

| Product number | | Item | | | Page | |
|----------------|----------|--|---|------------------|---------|--|
| SLT5006 | | Revision history | | | 1 | |
| date | revision | Change items | Contents | Person in charge | approve | |
| 2022.06.15 | 1.0.0 | | Creating a new | Oba | Dan | |
| 2022.09.22 | 1.0.1 | [10]Communication specification/ Cable / EN | The following is added to Remark H: Active L: Standby | Oba | Dan | |
| 2022.12.29 | 1.0.2 | [1]Scope 1-1 Specific applications [1]Scope 1-2 Unsuitable Application [2] Part number [13] Caution [15] Request | To revise company-wide regulations. * There is no change in technical content. To unify the notation with our other products. | Oba | Dan | |
| | | <i>Murata Manufacturing Co., Ltd.</i> | | | | |