

ALLNET Antenne 868MHz 10dbi Antenne (N-Female) YAGI ANT-868-10dbi-Yagi LoRA HELIUM IoT

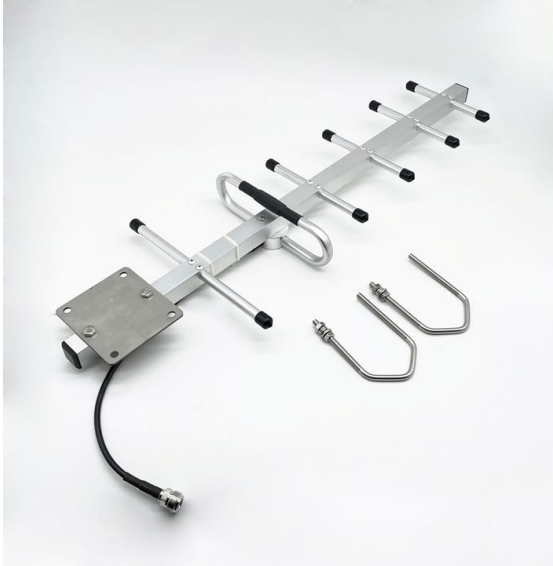

EAN CODE



Highlights:

- 860~896MHz Yagi Antenne 6 Elements
- Gewinn: 10dbi (Mehr Details siehe Tabelle)
- Abstrahlwinkel: 73°/55° (Mehr Details siehe Tabelle)
- Impedance: 50 Ohm
- VSWR: <=1.4
- Anschluss: N-Type Female (passende Anschlußkabel finden Sie im Zubehör)
- Abmessung: Länge = 582x202x55mm
- Windspeed: 200km/h
- Temperatur: -45°C ~ +75°C
- Montage: Mastmontage
- Verpackungsinhalt: Antenne und Montagezubehör
- **Ideal für LoRA / Helium Network / Helium Miner / IoT Endgeräte / 868MHz Systeme etc.**

Yagi-Antennen gehören zu den Längsstrahlern und verwenden strahlungserregte Elemente. Yagi-Antennen bestehen aus einer Gruppe von aktiven und passiven (parasitären) Elementen, welche durch gegenseitige Mitkopplung ein gemeinsames stark ausgeprägtes Richtdiagramm erzeugen. Sie bestehen aus oft nur einem gespeisten Element mit einer Anzahl von parasitär strahlungsgespeisten Elementen.

Robuste Konstruktion Hohe Verstärkung für hervorragende Punkt-zu-Punkt-Übertragung. Enge Abstrahlbreite und hohes F/B-Verhältnis minimieren Störungen durch andere Systeme

Technical Details:



Model	ANT-868-10dbi-Yagi	ANT-868-12.5dbi-Yagi	ANT-868-14dbi-Yagi
Electrical Specification	WideBand: 806-896MHz		
Polarization	Vertical Polarized / Horizontal Polarized		
Max Gain	10dbi	12.5dbi	14dbi
H Beamwidth (-3dB, V-Pol)	73° ± 7°	42° ± 5°	33° ± 5°
E Beamwidth	55° ± 5°	39° ± 3°	30° ± 5°
VSWR	<1.4		
Nominal Impedance	50 ohm		
F/B Ratio	>15dB	>17dB	>20dB
Max Power	100watts		
Mechanical Specification			
Connector	N-Female		
Radome	Fiberglass, Dia 20mm		
Color	White/Grey		
Dimension	582 * 202 * 55mm	941 * 202 * 55mm	1297 * 202 * 55mm
Weight incl Mount Kit	0.7kg	0.9kg	1.2kg
Max windload	200km/h, 125mph		
Working Temperature Range	-45°C to +75°C		
Storage Temperature	-50°C to +75°C		

Antenna Test Data:

2D Radio Pattern Model: ANT-868-10dbi-Yagi 6 Elements

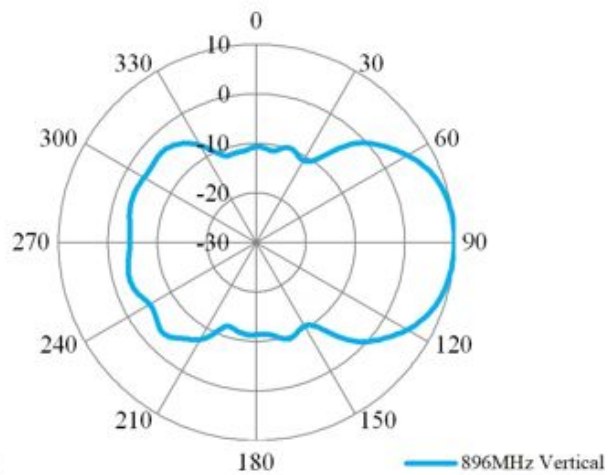
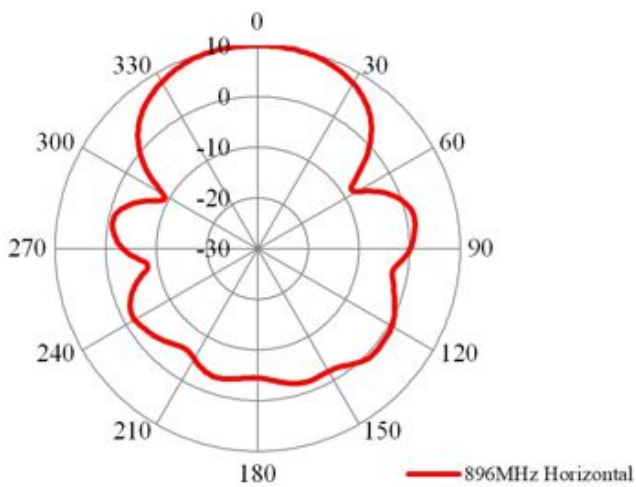
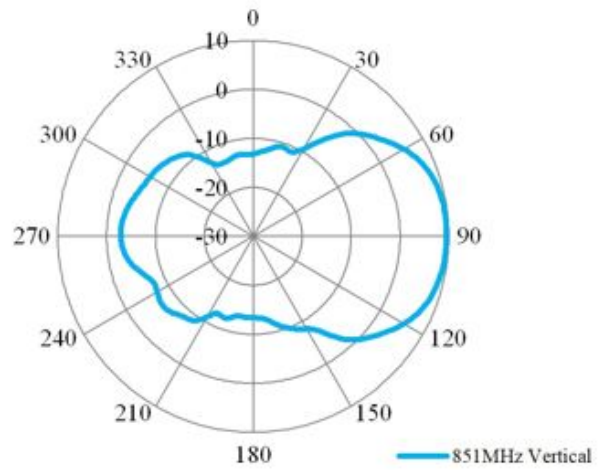
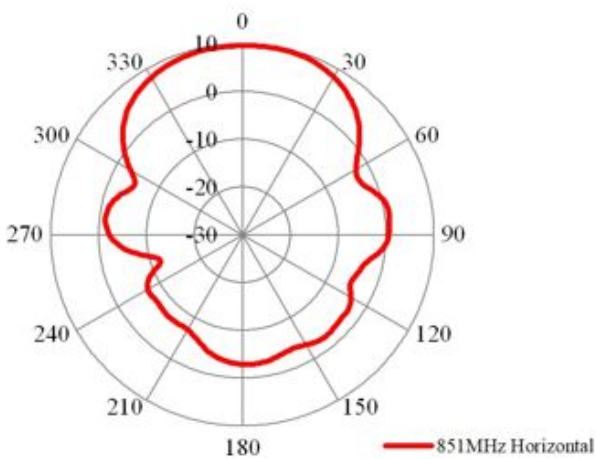
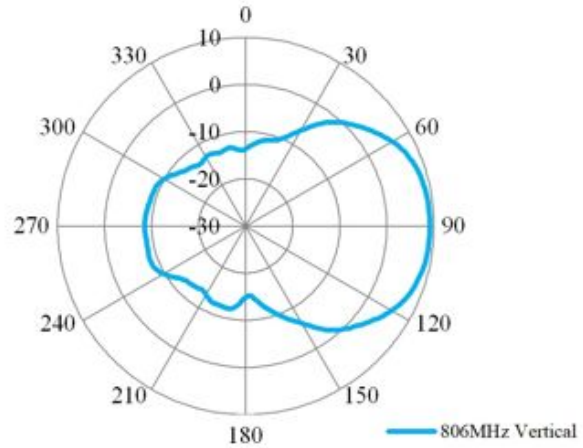
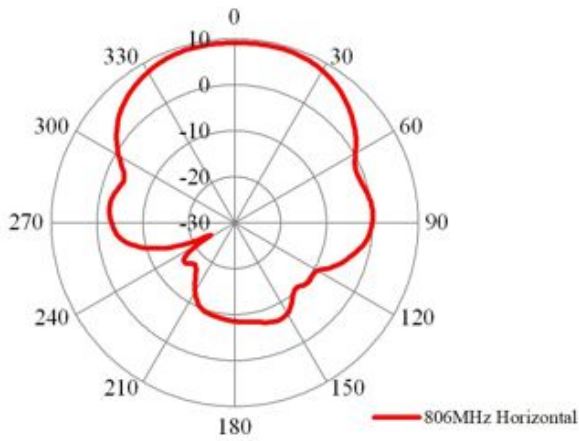

VSWR and Return Loss Model: ANT-868-10dbi-Yagi 6 Elements

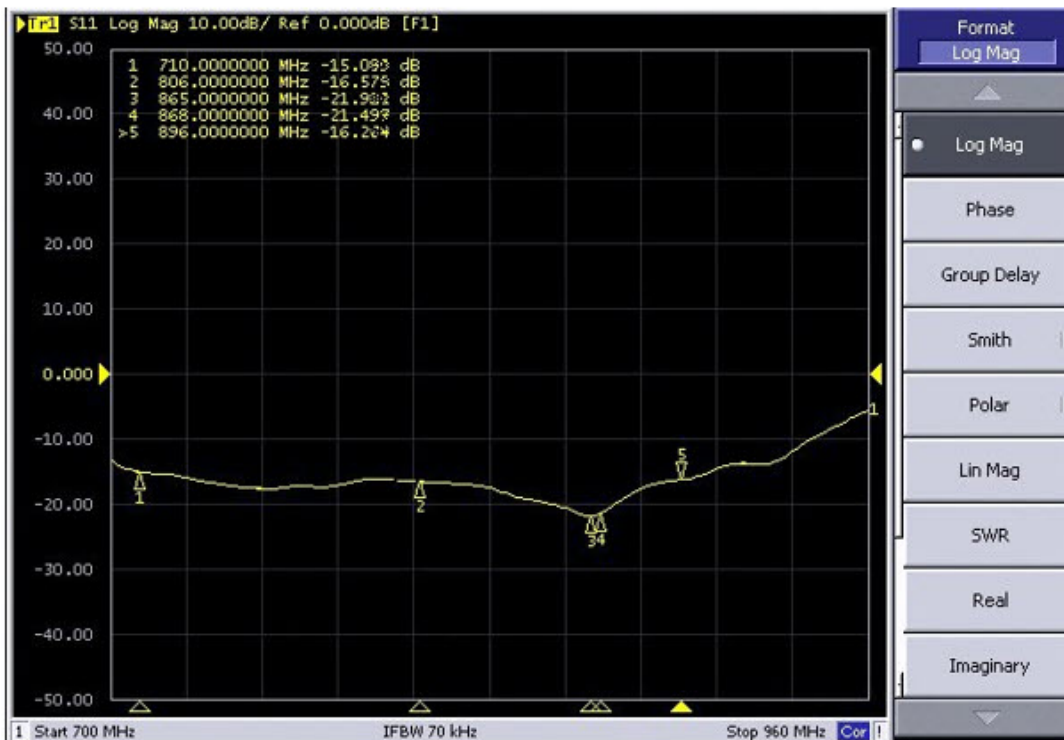
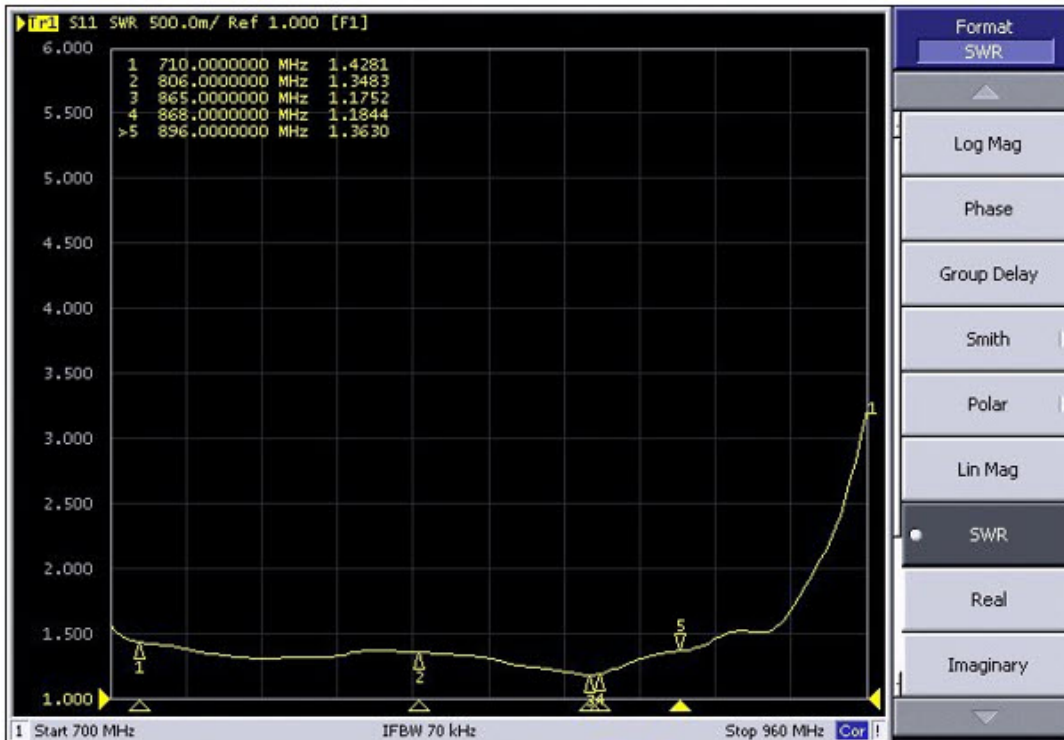



Art.-Nr.: 208181
Herst.-Nr.: ANT-868-10dbi-Yagi

Mechanical Dimmension:

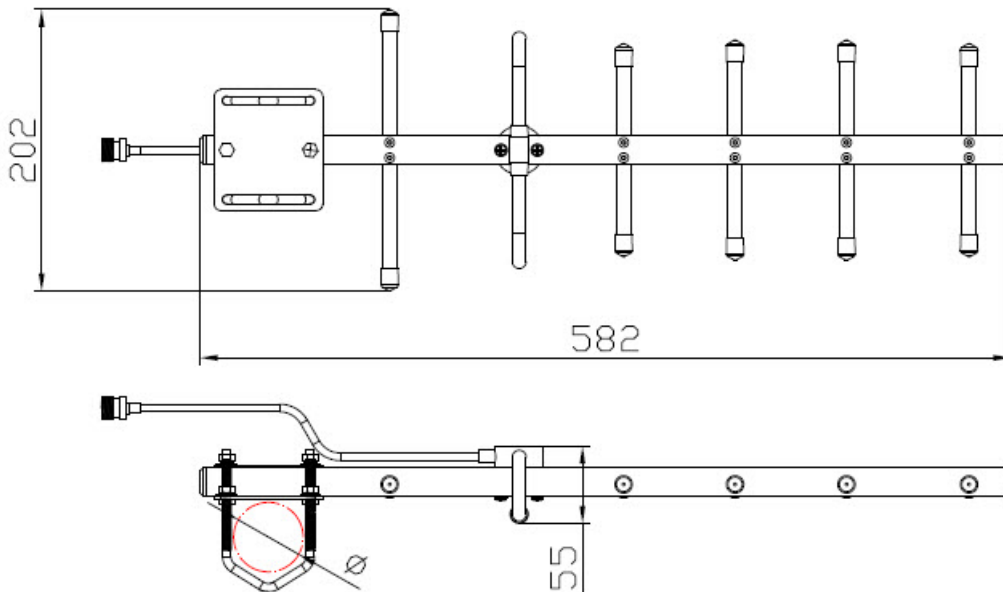
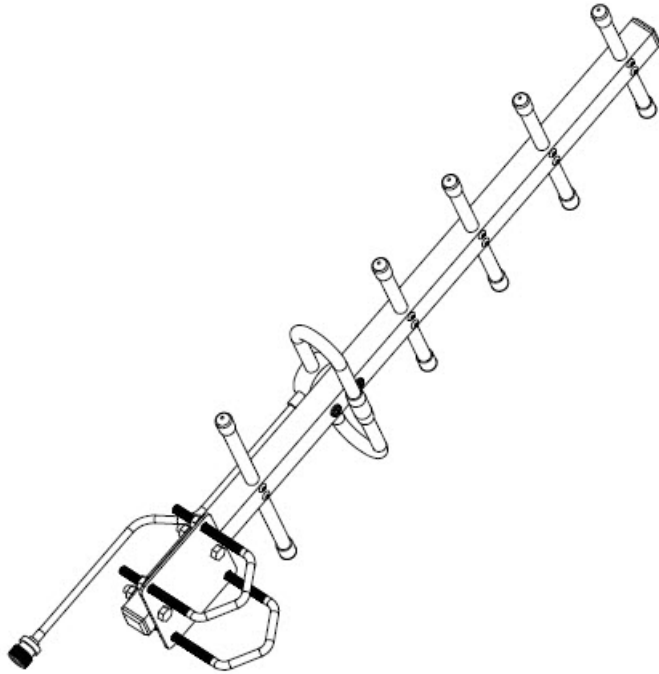

V-shape Bolts for Pole Dia
 $\varnothing 30\text{mm} \sim \varnothing 50\text{mm}$

Weitere Bilder

2D Radio Pattern Model: ANT-868-10dbi-Yagi 6 Elements

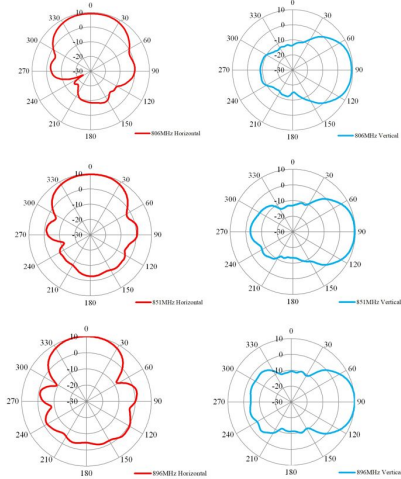

VSWR and Return Loss Model: ANT-868-10dbi-Yagi 6 Elements

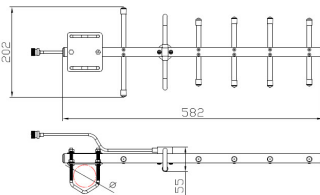
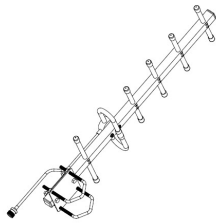

V-shape Bolts For Pole Dia
Ø30mm ~ Ø50mm

Zubehör

Art.-Nr.	Name
177056	ALLNET Antennen-Kabel LMR-195 R-SMA(m) <> N-Type(m) 1000 cm
88874	ALLNET Antennen-Kabel LMR-195 R-SMA(m) <> N-Type(m) 150 cm
88875	ALLNET Antennen-Kabel LMR-195 R-SMA(m) <> N-Type(m) 300 cm
88876	ALLNET Antennen-Kabel LMR-195 R-SMA(m) <> N-Type(m) 500 cm
88877	ALLNET Antennen-Kabel LMR-195 R-SMA(m) <> N-Type(m) 700 cm



Art.-Nr.: 208181
Herst.-Nr.: ANT-868-10dbi-Yagi

Art.-Nr.	Name
90403	ALLNET Antennen-Kabel LMR-195 N-Type(m) <> N-Type(m) 150 cm
90404	ALLNET Antennen-Kabel LMR-195 N-Type(m) <> N-Type(m) 300 cm
90405	ALLNET Antennen-Kabel LMR-195 N-Type(m) <> N-Type(m) 500 cm
93748	ALLNET Antennen-Kabel N-Type St (M)/St(M), RG-8, 1m, RF400,
93749	ALLNET Antennen-Kabel N-Type St(M)/St(M), RG-8, 2m, RF400,
93750	ALLNET Antennen-Kabel N-Type St(M)/St(M), RG-8, 3m, RF400,
93751	ALLNET Antennen-Kabel N-Type St (M)/St (M), RG-8, 5m, RF400,
93752	ALLNET Antennen-Kabel N-Type St (M)/St (M), RG-8, 7m, RF400,
78202	ALLNET Antennen-Blitzschutz 2,4~5 GHz N-Type M -> N-Type F