

E43355

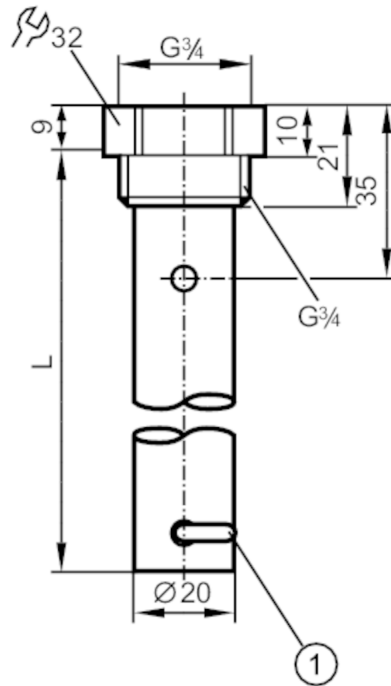

Coaxial pipe for level sensors

LR COAX TUBE G3/4 L265



1 fixing bracket for centring piece

CRN

Application	
Design	for level sensors LR
MAWP (for applications according to CRN) [bar]	16
Mechanical data	
Weight [g]	190.7
Materials	Coaxial pipe: stainless steel (1.4301 / 304); fixing bracket: stainless steel (1.4310 / 301); Centring piece: PP-GF30; Sealing: Aramid 20 / NBR80
Length [mm]	265
Accessories	
Accessories (supplied)	Sealing:, Aramid 20 / NBR80
Remarks	
Pack quantity	1 pcs.