

## Handwheels • DIN 950 light metal

24590.0541

### Product Description

Hub machined; rim turned and mirror-finished on all sides, non-machined surfaces cleanly blasted.

### Material

#### Handwheel

- Light metal Al

#### Machine handle DIN 39 EH 24450.

- Steel, turned, zinc-plated by galvanization, passivated

### Assembly

Shaft-end washers EH 22270. for axial fastening.

### More information

### Further products

- Shaft-End Washers
- Rotating Machine Handles, DIN 98



### Drawing

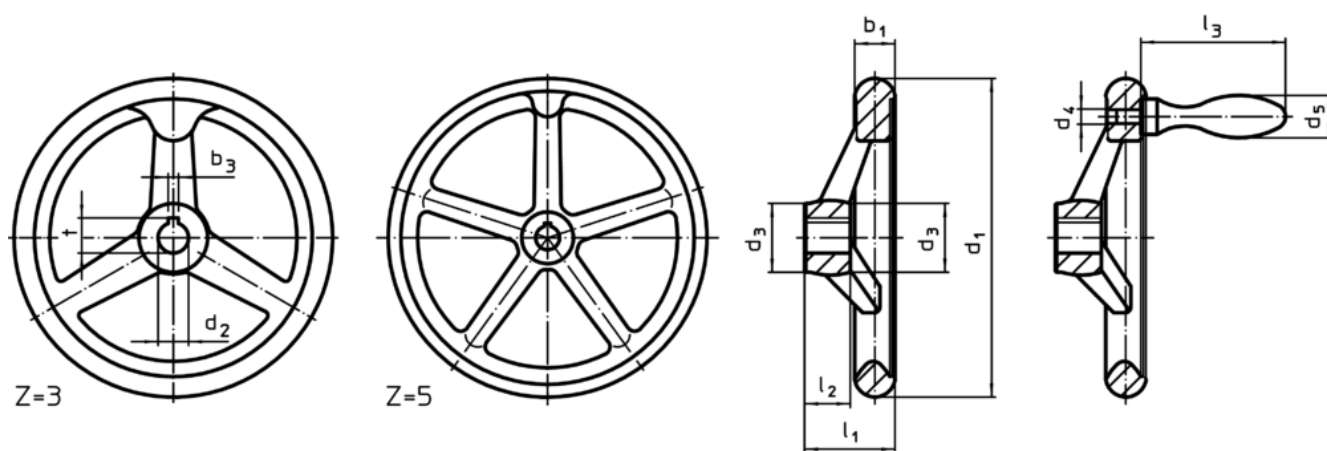

picture 1

picture 2

The orientation of the hub keyway may be different than shown in the drawing.

### Order information

Dimensions								Hub keyway, DIN 6885 sheet 1		Number of spokes z	Corresponding machine handle DIN 39 / DIN 98	[g]	Art. No.
d <sub>1</sub>	d <sub>2</sub> H7	d <sub>3</sub>	d <sub>4</sub>	d <sub>5</sub>	l <sub>1</sub> ~	l <sub>2</sub>	l <sub>3</sub> ~	b <sub>3</sub>	t				
with keyway, with machine handle EH 24450. assembled, form N-F/G (formerly: F 3) – picture 2													
250	26	45	M12	32	50	28	100	8	29.3	5	32	1860	24590.0541

## Application example

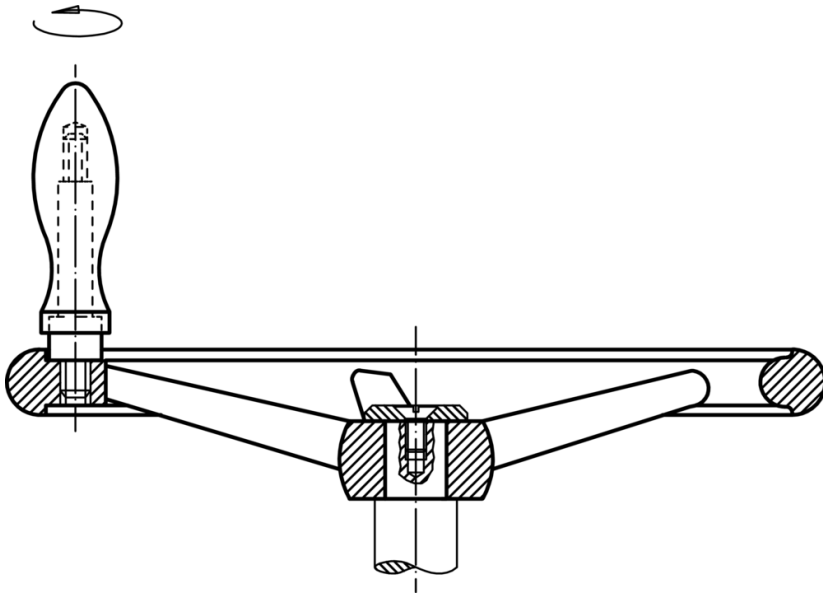

## Compliance

### RoHS compliant

Compliant according to Directive 2011/65/EU and Directive 2015/863

### Does not contain SVHC substances

No SVHC substances with more than 0.1% w/w contained - SVHC list [REACH] as of 10.06.2022

### Does not contain Proposition 65 substances

No Proposition 65 substances included

<https://www.P65Warnings.ca.gov/>

### Free from Conflict Minerals

This product does not contain any substances designated as "conflict minerals" such as tantalum, tin, gold or tungsten from the Democratic Republic of Congo or adjacent countries.