

OGH306

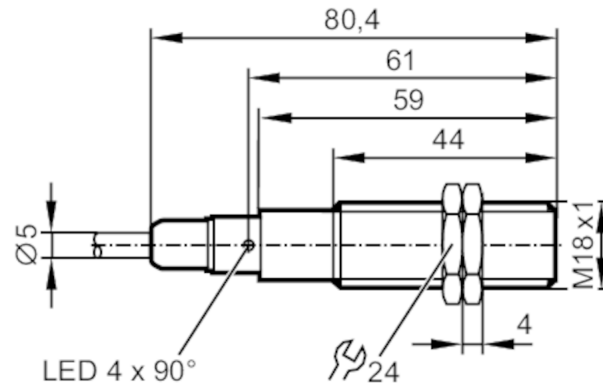

Diffuse reflection sensor with background suppression

OGH-HPKG/6M



Product characteristics

Type of light	red light
Housing	threaded type
Dimensions [mm]	M18 x 1 / L = 80.4

Application

Special feature	Background suppression
Function principle	Diffuse reflection sensor

Electrical data

Operating voltage [V]	10...36 DC
Current consumption [mA]	25
Protection class	II
Reverse polarity protection	yes
Type of light	red light

Outputs

Electrical design	PNP
Output function	light-on mode
Max. voltage drop switching output DC [V]	2.5
Permanent current rating of switching output DC [mA]	150; (200 (...60 °C))
Switching frequency DC [Hz]	1000
Short-circuit protection	yes
Type of short-circuit protection	pulsed
Overload protection	yes

OGH306



Diffuse reflection sensor with background suppression

OGH-HPKG/6M

Detection zone		
Range	[mm]	< 100; (white paper 200 x 200 mm 90% remission)
Range on white object (90 % remission)	[mm]	< 100
Range on grey object (18 % remission)	[mm]	< 100
Range on black object (6 % remission)	[mm]	< 100
Range adjustable		no
Max. light spot diameter	[mm]	9
Light spot dimensions refer to		Range
Background suppression available		yes
Operating conditions		
Ambient temperature	[°C]	-25...80
Protection		IP 65; IP 67; IP 68; IP 69K
Tests / approvals		
EMC		EN 60947-5-2
MTTF	[years]	372
Mechanical data		
Weight	[g]	267.5
Housing		threaded type
Dimensions	[mm]	M18 x 1 / L = 80.4
Thread designation		M18 x 1
Materials		housing: stainless steel (1.4404 / 316L); Sealing: EPDM
Lens material		PMMA
Displays / operating elements		
Display	switching status	1 x LED, yellow
Accessories		
Accessories (supplied)		lock nuts: 2 x
Remarks		
Remarks		operating voltage "supply class 2" according to cULus
Pack quantity		1 pcs.

OGH306



Diffuse reflection sensor with background suppression

OGH-HPKG/6M

Electrical connection

Cable: 6 m, PVC; 3 x 0.34 mm²

Connection



Core colours :

BK = black
BN = brown
BU = blue