



CIRCUIT BREAKER 3VA2 IEC FRAME 160 BREAKING CAPACITY CLASS L ICU=150KA @ 415 V 4POLE, LINE PROTECTION ETU320, LI, IN=100A OVERLOAD PROTECTION IR=40A ...100A SHORT CIRCUIT PROTECTION II=12 X IN NEUTRAL PROTECTION ADJUSTABLE(OFF,50%,100%) BUSBAR CONNECTION

Model		
product brand name		SENTRON
Product designation		Molded case circuit breaker
Design of the product		Line protection
Product variations		Selective Applications
Ground fault monitoring version		Without
Design of the auxiliary release		without auxiliary release
Design of the auxiliary switch		Without
Design of the operating mechanism		toggle handle
Type of the driving mechanism / motor drive		No
Design of the overcurrent release		ETU320

General technical data		
Number of poles		4
Trip class / of the L-trip / with I ² t characteristic / initial value		0.5
Trip class / of the L-trip / with I ² t characteristic / Full-scale value		17
Electrical endurance (switching cycles)		12 000
<ul style="list-style-type: none"> at AC-1 / at 380/415 V / at 50/60 Hz 		
circuit-breaker / Design		3VA
Mechanical service life (switching cycles) / typical		20 000

Voltage		
Insulation voltage / Rated value	V	800

Protection class		
------------------	--	--

Protection class IP		IP40
Protection class IP / on the front		IP40
Protective function of the overcurrent release		LI

Switching capacity

Switching capacity class of the circuit breaker		L
--	--	---

Dissipation

Active power loss		
<ul style="list-style-type: none"> • maximum 	W	7.7

Electricity

Continuous current / Rated value / maximum	A	160
Continuous current / Rated value	A	100
Adjustable response value current / of the instantaneous short-circuit release / initial value	A	1.5

Main circuit

Operating voltage		
<ul style="list-style-type: none"> • with AC / at 50/60 Hz / Rated value 	V	690
Operating current		
<ul style="list-style-type: none"> • at 40 °C / Rated value • at 50 °C / Rated value • at 60 °C / Rated value • at 65 °C / Rated value • at 70 °C / Rated value 	A	100
	A	100
	A	100
	A	100
	A	100

Auxiliary circuit

Number of NC contacts / for auxiliary contacts		0
Number of NO contacts / for auxiliary contacts		0

Suitability

Suitability for use		system protection
----------------------------	--	-------------------

Adjustable parameters

Adjustable response value current		
<ul style="list-style-type: none"> • of I-trip / Full-scale value 	A	12
Adjustable response value current / of the current-dependent overload release / initial value	A	0.4

Product details

Product component		
<ul style="list-style-type: none"> • Trip indicator • display • undervoltage release 		No
		No
		No
Product property		

• for neutral conductors / upgradeable/retrofitable / Short-circuit and overload proof	No
Product expansion / optional / motor drive	Yes

Product function

Product function	
• Intrinsic device protection	Yes
• communication function	No
• Phase failure detection	No
• other measurement function	No

Accessories

Manufacturer article number / of the supplied basic switch	3VA2110-8HL42-0AA0
--	------------------------------------

Short circuit

Operational short-circuit current breaking capacity (Ics)		
• at 240 V / Rated value	kA	200
• at 415 V / Rated value	kA	150
• at 440 V / Rated value	kA	150
• at 500 V / Rated value	kA	100
• at 690 V / Rated value	kA	18
Maximum short-circuit current breaking capacity (Icu)		
• at 240 V / Rated value	kA	200
• at 415 V / Rated value	kA	150
• at 440 V / Rated value	kA	150
• at 500 V / Rated value	kA	100
• at 690 V / Rated value	kA	24
Short-circuit current making capacity (Icm)		
• at 240 V / Rated value	kA	440
• at 415 V / Rated value	kA	330
• at 440 V / Rated value	kA	330
• at 500 V / Rated value	kA	220
• at 690 V / Rated value	kA	48

Connections

Arrangement of electrical connectors / for main current circuit	Front terminal
Type of connectable conductor cross-section	
• for flat-bar terminal connection / minimum	13 x 1 mm
• for flat-bar terminal connection / maximum	25 x 8.5
Type of electrical connection / for main current circuit	Lug terminal

Mechanical Design

Height	mm	181
Width	mm	140
Depth	mm	107
Mounting type		fixed mounting

Environmental conditions

Ambient temperature

• during operation / minimum	°C	-25
• during operation / maximum	°C	70
• during storage / minimum	°C	-40
• during storage / maximum	°C	80

Certificates

Equipment marking

• acc. to DIN EN 61346-2	Q
• acc. to DIN EN 81346-2	Q

General Product Approval

EMC

Declaration of Conformity

Shipping Approval



[other](#)



Shipping Approval

other

[other](#)



GL

Further information

Information- and Downloadcenter (Catalogs, Brochures,...)

<http://www.siemens.com/lowvoltage/catalogs>

Industry Mall (Online ordering system)

<https://eb.automation.siemens.com/mall/en/WW/Catalog/Product/3VA21108HL420AA0>

Service&Support (Manuals, Certificates, Characteristics, FAQs,...)

<http://support.automation.siemens.com/WW/view/en/3VA21108HL420AA0/all>

Image database (product images, 2D dimension drawings, 3D models, device circuit diagrams, ...)

http://www.automation.siemens.com/bilddb/cax_en.aspx?mfb=3VA21108HL420AA0

CAX-Online-Generator

<http://www.siemens.com/cax>

Tender specifications

<http://ausschreibungstexte.siemens.com/tiplv>

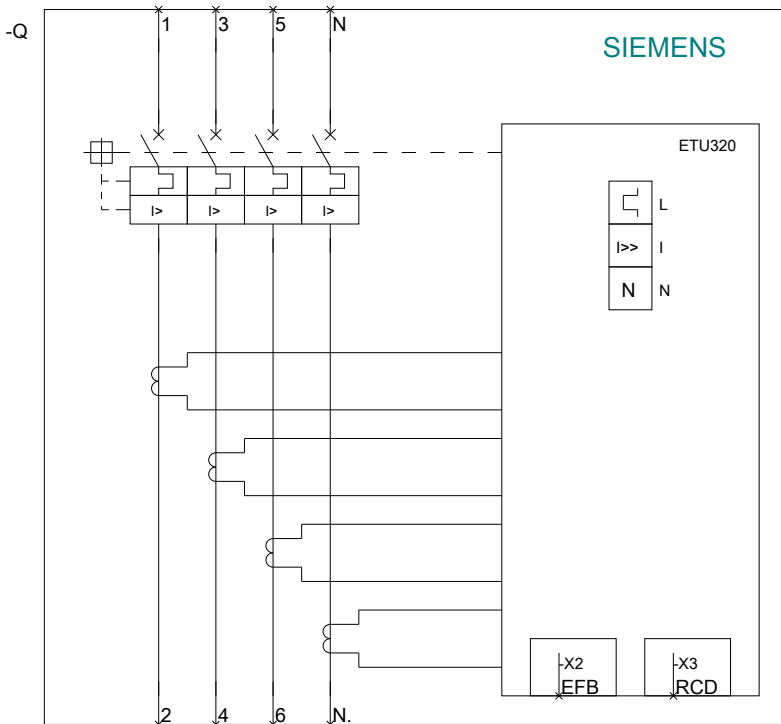
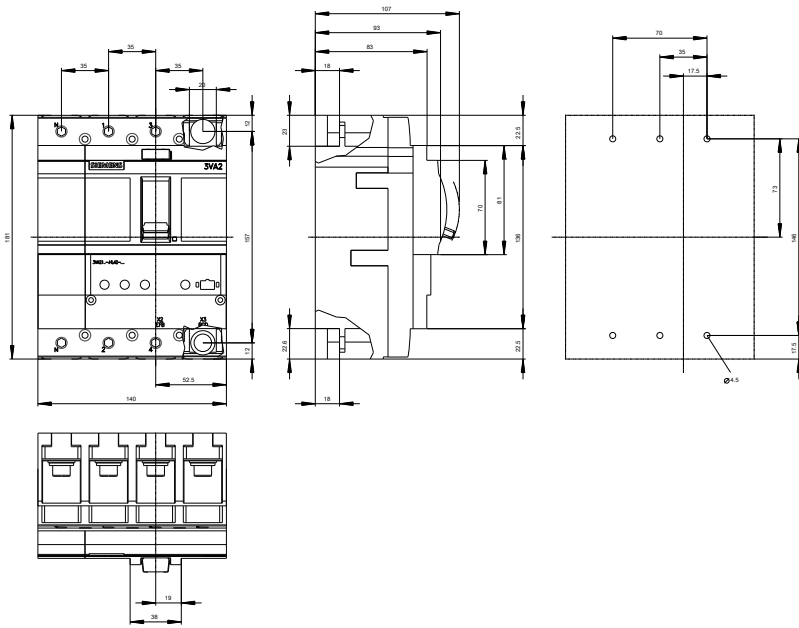

last modified:

11.03.2015