



Product Change Notification / GBNG-02EIPE100

Date:

14-Mar-2023

Product Category:

Wireless IC

PCN Type:

Manufacturing Change

Notification Subject:

CCB 6067 Initial Notice: Qualification of STAR as an additional final test site for MICRF221AYQS and MICRF221AYQS-TR catalog part numbers (CPN) available in 16L QSOP (3.90mm) package.

Affected CPNs:

[GBNG-02EIPE100_Affected_CPN_03142023.pdf](#)
[GBNG-02EIPE100_Affected_CPN_03142023.csv](#)

Notification Text:

PCN Status:Initial Notification

PCN Type:Manufacturing Change

Microchip Parts Affected:Please open one of the files found in the Affected CPNs section.
Note: For your convenience Microchip includes identical files in two formats (.pdf and .xls)

Description of Change:Qualification of STAR as an additional final test site for MICRF221AYQS and MICRF221AYQS-TR catalog part numbers (CPN) available in 16L QSOP (3.90mm) package.

Pre and Post Change Summary:

	Pre Change	Post Change	
Final Test Site	Unisem (M) Berhad	Unisem (M) Berhad	Stars

		Perak, Malaysia (UNIS)	Perak, Malaysia (UNIS)	Microelectronics (Thailand) Public Company Limited (STAR)
Base Quantity Multiple (BQM)	Tape and Reel	2500 units	2500 units	2500 units
	Tube	98 units	98 units	98 units
Pin 1 orientation	Tape and Reel	Q1	Q1	Q1
	Tube	Pin 1 toward white stopper	Pin 1 toward white stopper	Pin 1 toward grey stopper
Carrier Tape		Minor dimension change. See pre and post change for comparison.		
Cover Tape		No dimension change. See pre and post change for comparison.		
Plastic Reel		No dimension change. See pre and post change for comparison.		
Plastic Reel Color		Blue	Blue	Blue
Tube Dimension		No dimension change. See pre and post change for comparison.		
Tube Plug Color		Full Tube: White – Black Partial Tube: White – Yellow	Full Tube: White – Black Partial Tube: White – Yellow	Grey-Grey
Packing Method		See pre and post change for comparison.		

Impacts to Data Sheet:None

Change Impact:None

Reason for Change:To improve manufacturability and on-time delivery performance by qualifying STAR as an additional final test site.

Change Implementation Status:In Progress

Estimated Qualification Completion Date:March 2023

Note: Please be advised the qualification completion times may be extended because of unforeseen business conditions however implementation will not occur until after qualification has completed and a final PCN has been issued. The final PCN will include the qualification report and estimated first ship date. Also note that after the estimated first ship date guided in the final PCN customers may receive

pre and post change parts.

Time Table Summary:

	March 2023				
Workweek	09	10	11	12	13
Initial PCN Issue Date			x		
Qual Report Availability				x	
Final PCN Issue Date				x	

Method to Identify Change:Traceability code

Qualification Plan:Please open the attachments included with this PCN labeled as PCN_#_Qual_Plan.

Revision History:March 14, 2023: Issued initial notification.

The change described in this PCN does not alter Microchip’s current regulatory compliance regarding the material content of the applicable products.

Attachments:

[PCN_GBNG-02EIPE100_Pre_and_Post_Change_Summary.pdf](#)

[PCN_GBNG-02EIPE100_Qual_Plan.doc.pdf](#)

Please contact your local [Microchip sales office](#) with questions or concerns regarding this notification.

Terms and Conditions:

If you wish to receive Microchip PCNs via email please register for our PCN email service at our [PCN home page](#) select register then fill in the required fields. You will find instructions about registering for Microchips PCN email service in the [PCN FAQ](#) section.

If you wish to change your PCN profile, including opt out, please go to the [PCN home page](#) select login and sign into your myMicrochip account. Select a profile option from the left navigation bar and make the applicable selections.

Affected Catalog Part Numbers (CPN)

MICRF221AYQS

MICRF221AYQS-TR



MICROCHIP

QUALIFICATION PLAN SUMMARY

PCN #: GBNG-02EIPE100

Date

January 19, 2023

**Qualification of STAR as an additional final test site for
MICRF221AYQS and MICRF221AYQS-TR catalog part
numbers (CPN) available in 16L QSOP (3.90mm) package.**

Purpose: Qualification of STAR as an additional final test site for MICRF221AYQS and MICRF221AYQS-TR catalog part numbers (CPN) available in 16L QSOP (3.90mm) package.

CCB No.: 6067

Test Name	Test Conditions	Sample Size	Qty of Lots	Fail/Accept Criteria
Bin and Yield Comparison	Test the same units at existing and destination locations and compare BIN and Yield data.	3000	1	≤0.1%
Parametric / Characterization Comparison	Characterize the same units at existing and destination locations and compare data.	33	1	≤10%
Test flow	Final Test Room 100% -> QA Sample Room.	3000	1	1% LTPD

CCB 6077
Pre and Post Change Summary
PCN #: GBNG-02EIPE100



A Leading Provider of Smart, Connected and Secure Embedded Control Solutions

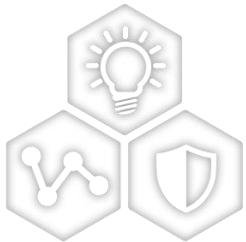

SMART | CONNECTED | SECURE

Pre and Post Change – Tape and Reel

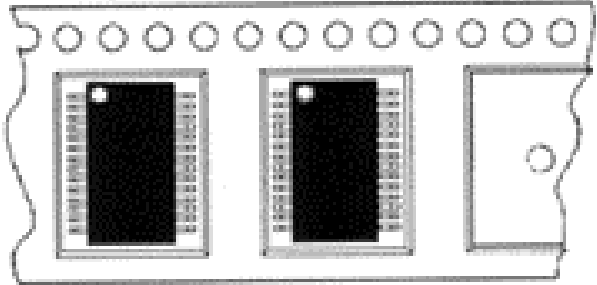
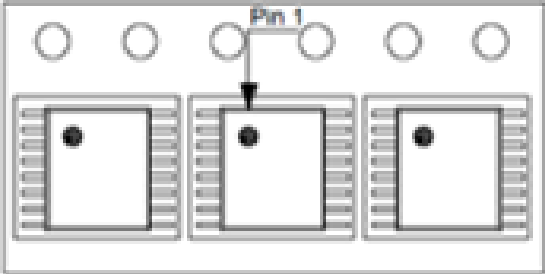
	UNIS	STAR
BQM (Base Quantity Multiple)	2500 per reel	2500 per reel
Pin 1 orientation	 <p>Quadrant 1</p>	 <p>Quadrant 1</p>

Pre and Post Change – Plastic Reel

UNIS

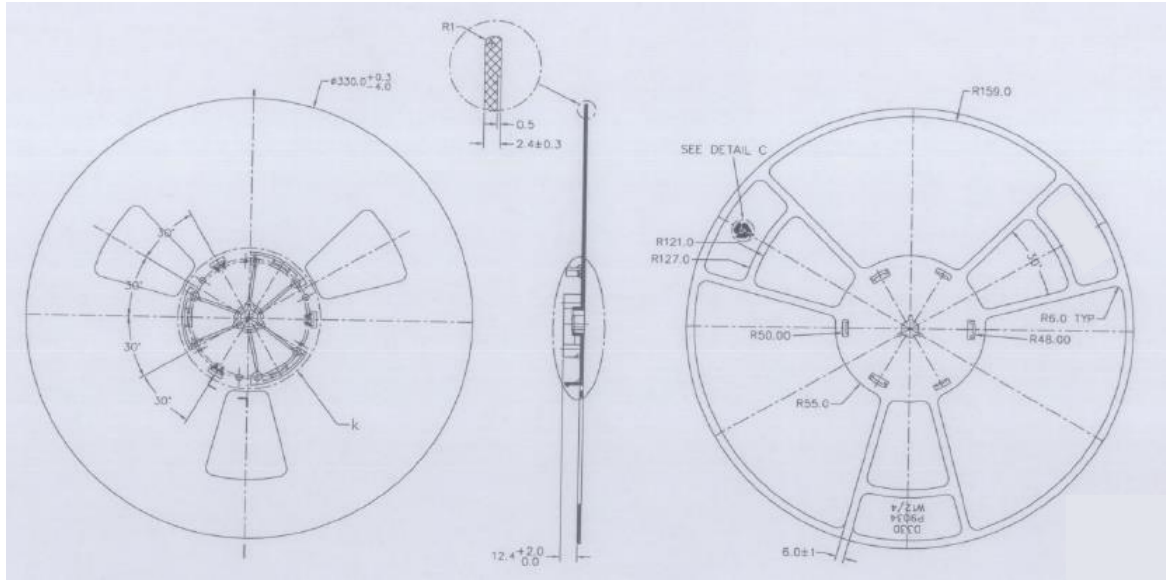

NOTES:

- UNLESS OTHERWISE SPECIFIED
1. MATERIAL: POLYSTYRENE(BLUE)
2. ANTISTATIC COATED
3. FLANGE WARPAGE : 3 MM MAXIMUM
4. ALL DIMENSIONS ARE IN MM
5. ESD - SURFACE RESISTIVITY
- 10^8 TO 10^{11} OHMS/50
6. GENERAL TOLERANCE : -X.X=±0.4, -X.XX=±0.20
7. TOTAL THICKNESS OF REEL: 18.4 MAX
8. PART NO: P9034

STAR

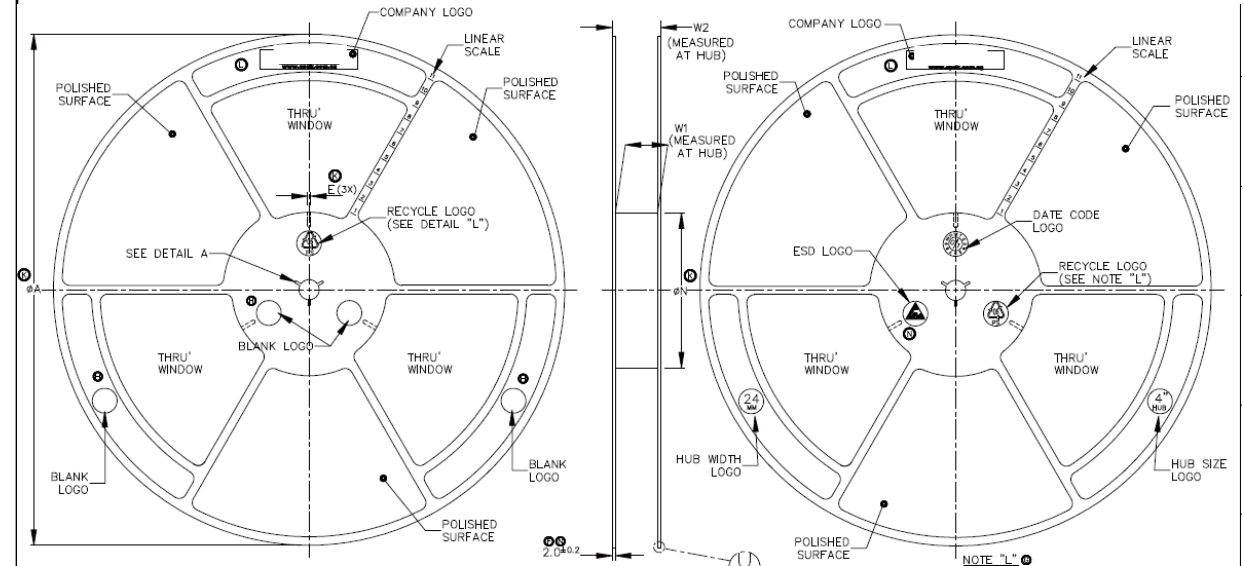

TAPE WIDTH	SR RANGE		TYPE		COLOUR	
	10 ⁸ TO 10 ¹¹	10 ⁹ TO 10 ¹⁰	ANTISTATIC	STATIC DISSIPATIVE	BLACK ONLY	ALL TYPES
08MM	330	100	8.4	14.4	2.5	
12MM	330	100	12.4	18.4	2.5	
16MM	330	100	16.4	22.4	2.5	
24MM	330	100	24.4	30.4	2.5	
32MM	330	100	32.4	38.4	2.5	

LEGEND	SR RANGE	TYPE	COLOUR
A	BELOW 10 ¹²	ANTISTATIC	ALL TYPES
B	10 ⁸ TO 10 ¹¹	STATIC DISSIPATIVE	BLACK ONLY
C	10 ⁹ & BELOW 10 ⁹	CONDUCTIVE (GENERIC)	BLACK ONLY
C	10 ⁹ TO 10 ⁹	CONDUCTIVE (CUSTOM)	BLACK ONLY
E	BELOW 10 ¹²	COATED ANTISTATIC	ALL COLOR

- NOTE:
- GENERIC PRODUCT
 - FOR PRODUCT DRAWING ONLY.
 - SANDBLAST ALL SURFACE UNLESS OTHERWISE STATED.
 - MOLD 2

TITLE : 13X4 WELDED REEL			
S.R.	TOL. NO.	PTG. NO.	POI.
SCALE : NTS	SHRINKAGE :	0.45%	TOLERANCE :
REV. :	MATERIAL :	PS	X.X ± 0.25
UNIT :	WARPAGE :		X.XX ± 0.13
SHT :	NAME :		DATE :
DRAWN :	AFIZAH	150605	X ± 30°
CHECK :	SHUKRI	150605	X.X ± 15°

No dimension change.

Pre and Post Change – Carrier Tape

UNIS

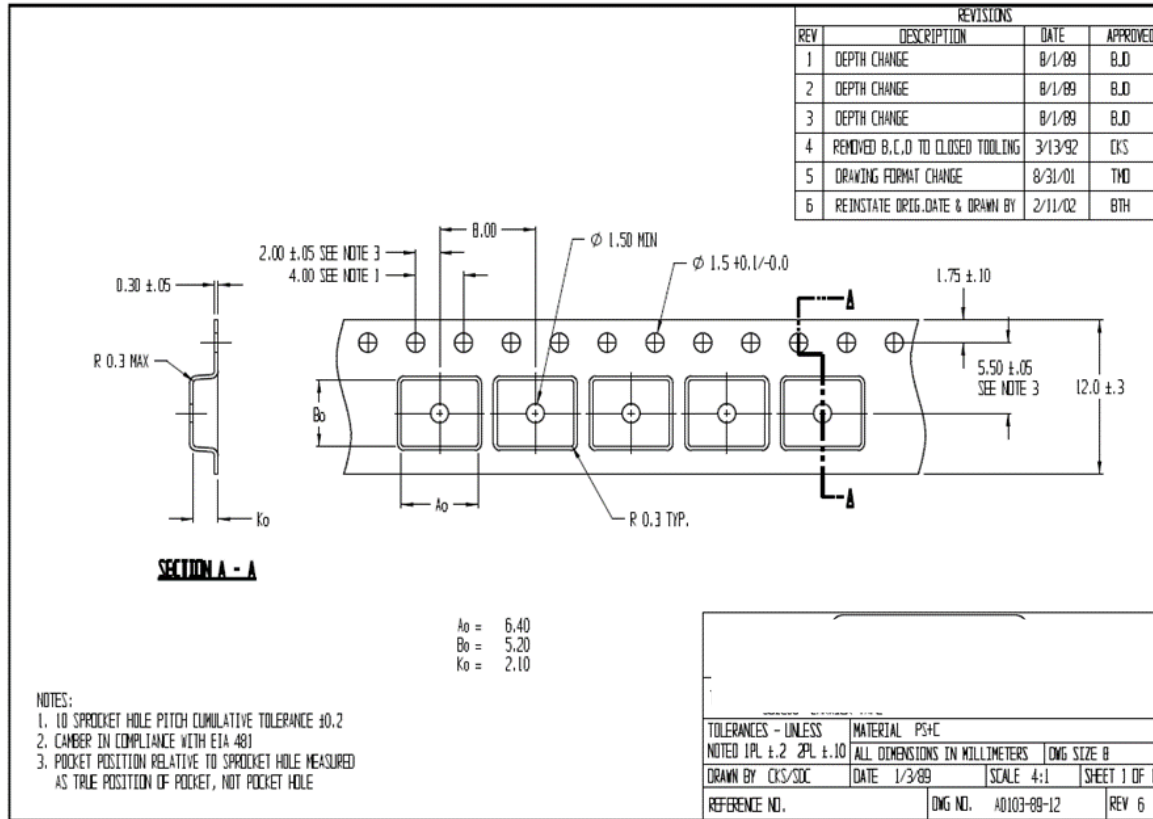

STAR

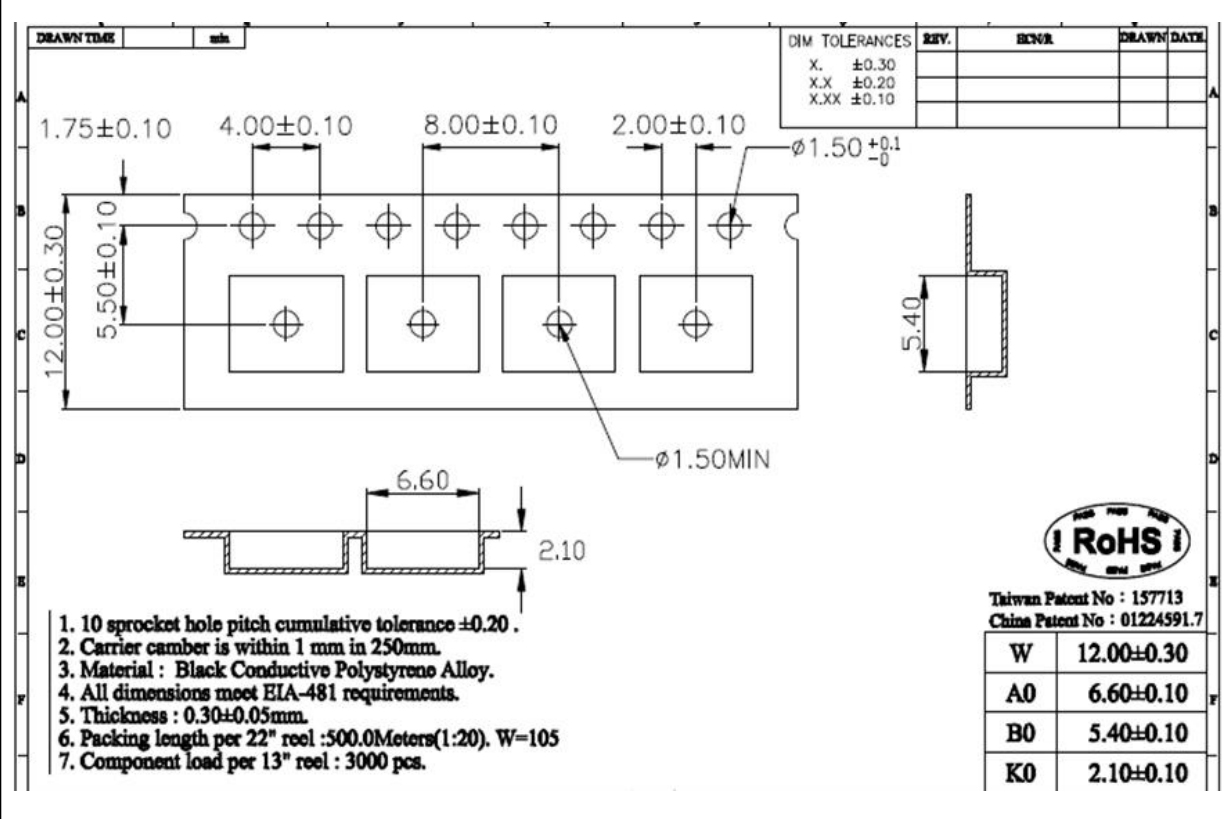

Plant	W (mm.) ± 0.3 or Specific	P (mm.) ± 0.1 or Specific	A ₀ ± 0.1 or Specific	B ₀ ± 0.1 or Specific	K ₀ ± 0.1 or Specific
UNIS	12	8	6.40	5.20	2.10
STAR	12	8	6.60	5.40	2.10

Pre and Post Change – Cover Tape

UNIS

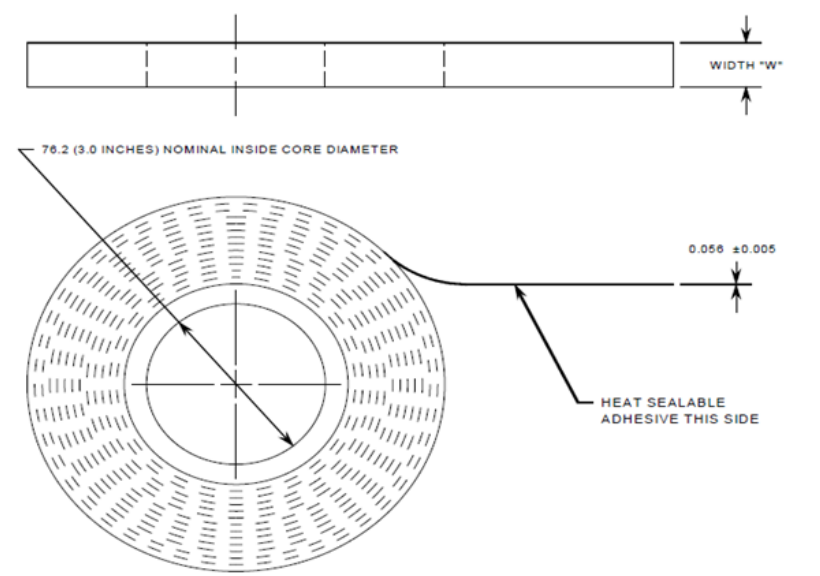

76.2 (3.0 INCHES) NOMINAL INSIDE CORE DIAMETER

WIDTH "W"

0.056 ± 0.005

HEAT SEALABLE ADHESIVE THIS SIDE

REVISIONS			
No.	ECO Number	Date	By
2	SEE A1111-93-2 REV. 2		
3	A10076	4/2/98	T.S.
4	A10076	3/24/98	T.S.
5	A-10134	3/11/99	T.S.

PART NO.	WIDTH "W"
AA05305NP	5.3±0.1mm
AA05405NP	5.4±0.1mm
AA09205NP	9.2±0.1mm
AA09505NP	9.5±0.1mm
AA13105NP	13.1±0.1mm
AA13305NP	13.3±0.1mm
AA13405NP	13.4±0.1mm
AA21005NP	21.0±0.1mm
AA21305NP	21.3±0.1mm
AA25505NP	25.5±0.1mm
AA37505NP	37.5±0.1mm
AA49505NP	49.5±0.1mm
AA65505NP	65.5±0.15mm
AA81505NP	81.5±0.15mm
AA97505NP	97.5±0.20mm
AA11355NP	113.5±0.20mm
AA12955NP	129.5±0.25mm
AA14555NP	145.5±0.25mm
AA16155NP	161.5±0.30mm
AA17755NP	177.5±0.30mm
AA19355NP	193.5±0.30mm

- All Dimensions in Millimeters -

NOTE:
 1. REEL TO CONTAIN 300 METERS OF SPLICE FREE MATERIAL.
 2. MATERIAL: ANTISTATIC POLYESTER FILM.
 3. COLOR: TRANSPARENT, PALE BLUE.
 4. THESE WIDTHS ARE ALSO AVAILABLE IN 500 METER LENGTHS.

STAR

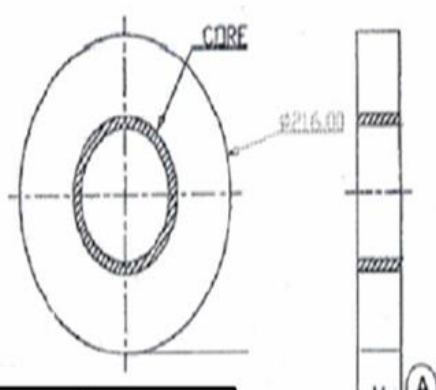

CORE

Ø216.00

W A

Cover Tape Certificate of Conformance







Primary ESD Function: Antistatic
 Item Number: 15280052H
 Description: CP230-092A L300 /
 Width (mm): 9.20 mm
 Lot Number: H806387-42 /
 Manufacturing Date: 26 Apr 2021
 Expiry Date: 26 Apr 2023
 Inspector: 5201

Specification	Maximum	Minimum	Average	
Width (mm)	9.20 +/- 0.10 mm	9.23 mm	9.16 mm	9.20 mm
Thickness (mm)	0.056 +/- 0.005 mm	0.063 mm	0.063 mm	0.063 mm
Top Surface Resistivity	1.0E+9 to 9.9E+10 ohms/sq	4.4E+9 ohms/sq	4.1E+9 ohms/sq	4.3E+9 ohms/sq
Adhesive Surface Resistivity	1.0E+9 to 9.9E+10 ohms/sq	3.8E+9 ohms/sq	3.1E+9 ohms/sq	3.5E+9 ohms/sq
Peel Strength	55 +/- 15 grams	49.0 grams	47.0 grams	48.0 grams
Haze	75% Max	57.2	57.1	57.15

Width size (mm.)	Specification (mm.)
5.3	5.2 - 5.4
9.2	9.1 - 9.3
13.3	13.2 - 13.4

Plant	Carrier Tape Width	Cover Tape Width	Thickness	Color	Sealing mythology
UNIS	16mm	13.3 +/-0.1mm	0.056+/-0.005	Clear	Heat sealing
STAR	16mm	13.3 +/-0.2mm	0.050+/-0.005	Clear	Heat sealing



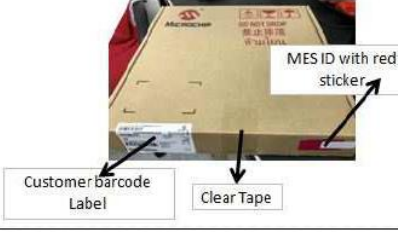

Pre and Post Change – Tape and Reel Packing Method

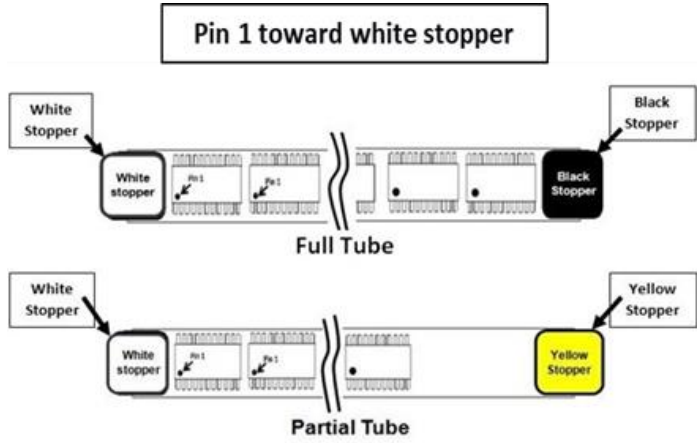
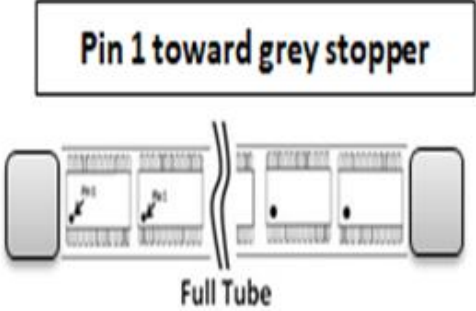
UNIS	STAR
 <p>Microchip Barcode label</p> <ol style="list-style-type: none"> 1) 13" Blue Reel - D330-P9034-W12/4 (P/N: 47370032) 2) Microchip Barcode label (P/N: 50320185) 3) 12mm Protective band (P/N: 47560001) 	
<div style="display: flex; justify-content: space-around;"> <div style="text-align: center;"> <p>Front</p>  <p>ESD LOGO Customer Barcode Label</p> </div> <div style="text-align: center;"> <p>Back</p>  <p>Adhesive ESD tape</p> </div> </div> <ol style="list-style-type: none"> 1) Static Shield Bag 16"X16" (P/N: 50020046) 2) Microchip Standard Barcode Label (P/N:50320185) at below ESD Logo <p>Back:</p> <ol style="list-style-type: none"> 1)Seal Antistatic shield bag with adhesive ESD tape. 	 <p>Packing in Reel 13 Inch → Insert Reel in static shielding ba → Packing in box → Put label</p>
<div style="display: flex; justify-content: space-around;"> <div style="text-align: center;">  <p>ESD LOGO Customer Barcode Label</p> </div> <div style="text-align: center;">  <p>Antistatic Bubble bag</p> </div> </div> <ol style="list-style-type: none"> 1)Quantity/box = 1 reel 2) Use antistatic bubble bag sheet fill in the space if much space inside the box 	
 <p>MES ID with red sticker</p> <p>Customer Barcode Label</p> <p>Clear Tape</p> <ol style="list-style-type: none"> 1) Microchip Box = M02-009 Brown-Pizza-13" (P/N: 50080187) 2) Microchip Standard Barcode Label (P/N:50320185) at left side of box opening 3) Red sticker with MES ID at right side of box opening 4) Seal box opening with clear tape at the middle <p>(Note: Remove red sticker with MES ID before ship to customer)</p>	

Pre and Post Change – Tube

	UNIS	STAR
BQM (Base Quantity Multiple)	98 units	98 units
Pin 1 orientation	<p>Pin 1 toward white stopper</p> 	<p>Pin 1 toward grey stopper</p> 
Tube Color	Clear tube	Clear tube
Plug Color	Full Tube: White – Black Partial Tube: White – Yellow	Grey-Grey

Pre and Post Change – Tube Packing Method

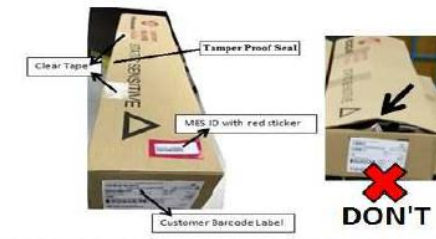
UNIS	STAR
 <p>Meratakan sebelum balut bubble bag</p>	
 <p>Customer Barcode Label</p> <p>Front</p> <p>ESD 1090</p> <p>Back</p> <p>ESD adhesive tape</p>	 <p>Packing units in tube</p> <p>Insert Tube in ESD bag</p> <p>Insert bag in inner box</p>
	
 <p>Clear Tape</p> <p>Tamper Proof Seal</p> <p>MES ID with red sticker</p> <p>Customer Barcode Label</p> <p>DON'T</p>	

- 1) 1 Bundle = Max 150 Tubes
 - 2) Bubble bag sheet wrap on both end side of tube and seal with adhesive ESD tape
- Note: Meratakan tube sebelum balut bubble bag.

- 1) Antistatic Shield Bag 12"X32" (P/N: 50020053)
- 2) 1 Bag = 1 bundle = Max 150 Tubes
- 3) Microchip Barcode Label (P/N: 50320185) on front of Antistatic Shield Bag
- 4) Seal the excess Antistatic shield bag with ESD adhesive tape at the back

- 1) Microchip Box = M02-011 Big Tube Inner" Brown (P/N: 50080188)
- 2) 1 box = Max 1 bag
- 3) Use anti-static bubble bag sheet to fill the space if much space inside the box

- 1) Microchip Barcode Label (P/N: 50320185) at the right side of box
 - 2) Seal the box opening with 2 x clear tapes
 - 3) Tamper-Proof Seal at the middle of box opening
- (Note: Remove MES ID with red sticker before ship to customer)