

10/12 Watt Multi Head Power Supplies



DESCRIPTION

A range of R-TECH 10/12W Interchangeable Multi-head AC/DC Power Adapters.

DISTINCTIVE FEATURES

- Interchangeable AC Heads
- DOE Level VI Efficiency
- Overcurrent Protection
- Short Circuit Protection
- Centre Positive Connection
- 5 and 12VDC
- RoHS Compliant
- 1 Year Warranty
- EN62368 Approved
- Cable Length 1.5 Metres

APPLICATIONS

The multi-head design allows use in a variety of countries and is ideal for use with Audio Visual equipment, and Information Technology products that require a 10 or 12W power supply with 2.1x5.5x12mm Centre Positive connector.

10/12W

5 &
12VDC

1 & 2A

UK

EU

US

AUS

1.5m



ELECTRICAL SPECIFICATION

Output	85-7065	85-7066
DC Voltage	5VDC	12VDC
Rated Current	2A	1A
Current Range	0-2A	0-1A
Rated Power	10W	12W
Ripple & Noise	200mVp-p max	
Output Regulation	±5%	
Output Connector	2.1x5. 5x12mm Centre Positive	

Short circuit and over current protected

Input	
Voltage Range	90-264VAC
Frequency Range	47-63Hz
Nominal Voltage Range	100-240VAC
Nominal Frequency Range	50-60Hz
Input Current	1.2A Max
Inrush Current	40A Max
Standby Power	0.1W Max
Leakage Current	0.25A Max
Input Connector	UK, EU, US & AUS AC Heads



GENERAL SPECIFICATION

Series	Power Supplies
Type	Multi head AC/DC Adapter
RoHS Compliant	Yes
DOE	Level VI Efficiency
Class Rating	Class II Double Insulated



MATERIALS

Case Material	Polycarbonate
Case Colour	Black



CERTIFICATION AND STANDARDS

Safety Standards	UL/CUL 62368-1, GS/TUV EN62368-1, SAA AS/NZ62368-1
EMC Emissions	EN55032, EN55035, FCC Part 15 Class B



ENVIRONMENTAL/OPERATING SPECIFICATION

Operating Temperature	0°C~40°C
Cooling	Convection
Temperature Coefficient	0.05%/°C
Humidity	5~95%RH (non-condensing)
Storage Temperature	-20°C~+80°C
Temperature resistance polycarbonate case	120°C (material meets the requirements of ball pressure test)
Operating Environment	Designed for indoor use only, and not suitable for use in damp or wet conditions



DIMENSIONS/DRAWINGS

Units	mm - unless stated otherwise
Overall Dimensions	59 x 40.9 x 32.1mm
Cable Length	1.5m
Weight	150g

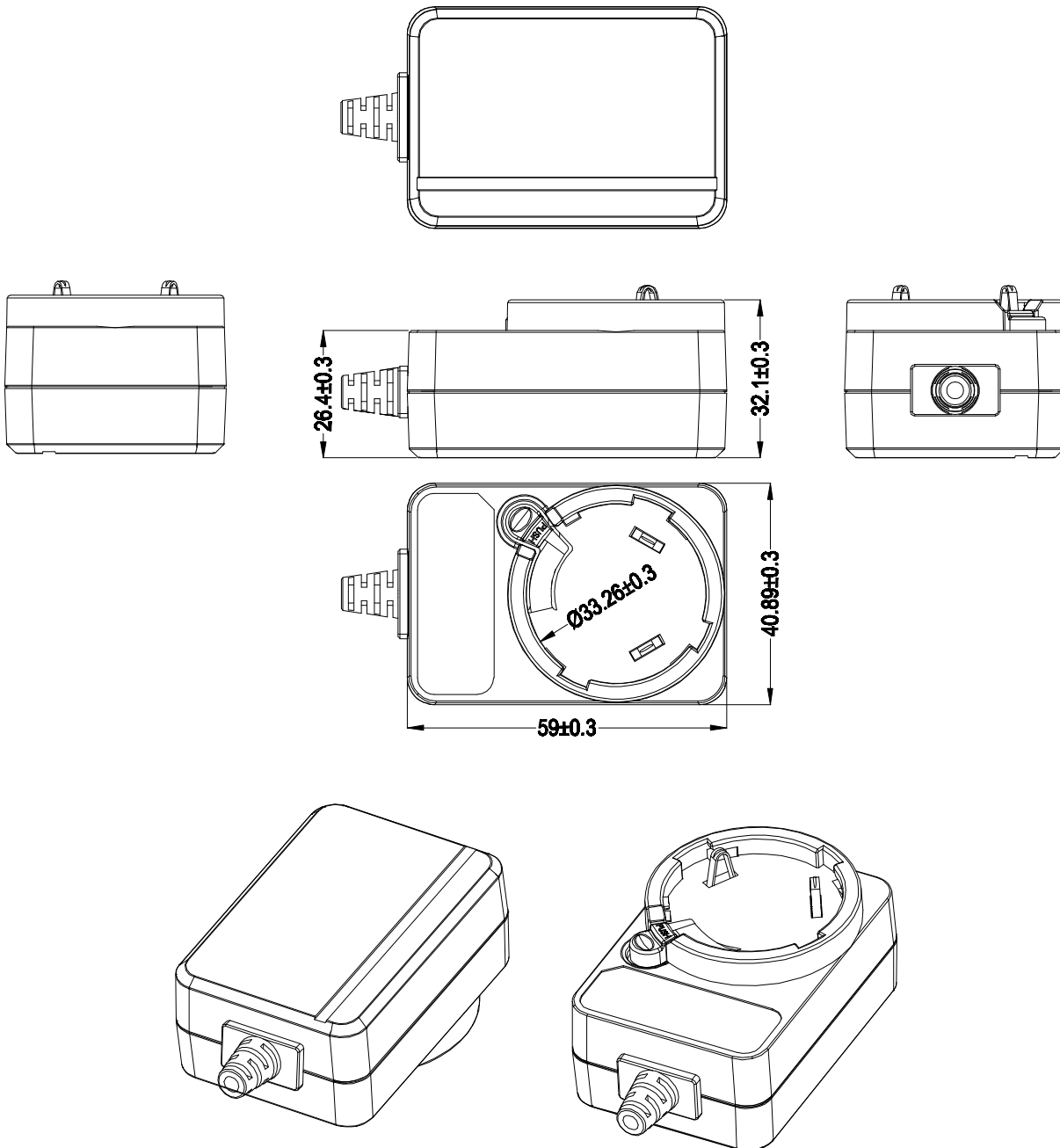

UK AC PLUG

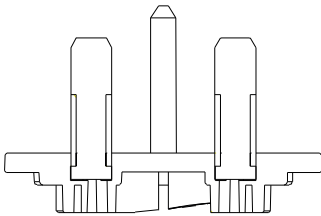
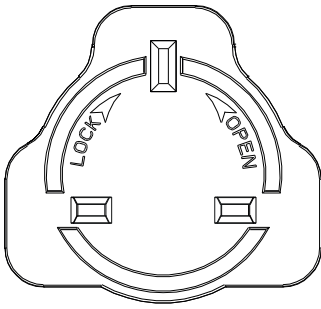

US AC PLUG

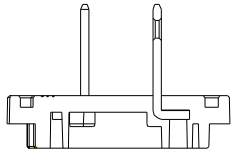
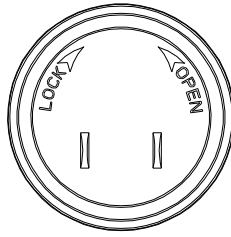

AU AC PLUG

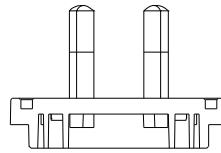
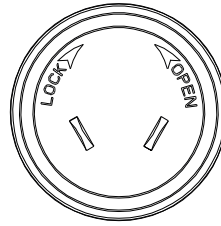

EU AC PLUG

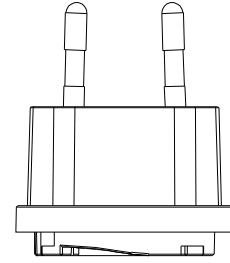
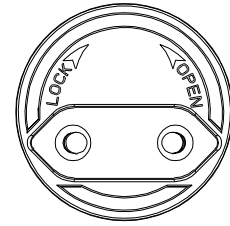

OPTIONS (MOQ may apply)

Voltage	9VDC
Connectors	Eg Right angle style
Polarity	Centre Negative



PART NUMBER TABLE

Part number	DC Voltage	Rated Current	Current Range	Rated Power	UNSPSC	EAN	Country of Origin
85-7065	5VDC	2A	0-2A	10W	39121004	5053556007868	China
85-7066	12VDC	1A	0-1A	12W	39121004	5053556007875	China

R-TECH

Tried & trusted technology

Important Notice: This data sheet and its contents (the "Information") belong to Rapid Electronics Limited or are licensed to it. No licence is granted for the use of it other than for information purposes in connection with the products to which it relates. No licence of any intellectual property rights is granted. The Information is subject to change without notice and replaces all data sheets previously supplied. The Information supplied is believed to be accurate but Rapid Electronics Limited assumes no responsibility for its accuracy or completeness, any error in or omission from it or for any use made of it. Users of this data sheet should check for themselves the Information and the suitability of the products for their purpose and not make any assumptions based on information included or omitted. Liability for loss or damage resulting from any reliance on the Information or use of it (including liability resulting from negligence or where Rapid Electronics Limited were aware of the possibility of such loss or damage arising) is excluded. This will not operate to limit or restrict Rapid Electronics Limited's liability for death or personal injury resulting from its negligence.