

E12524

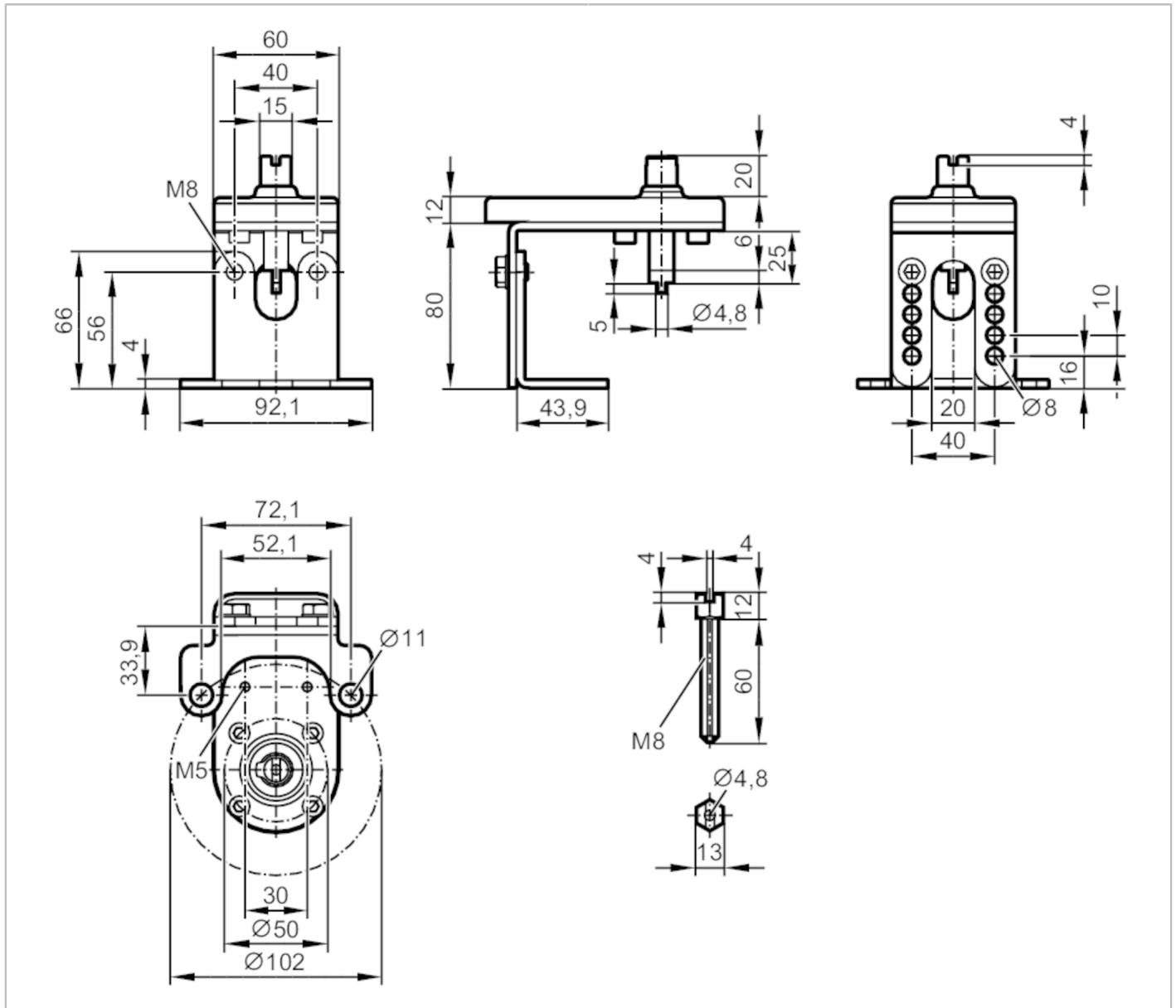

Mounting set for manual valves and ball valves

MOUNTING KIT FOR MANUAL VALVES F10/M8



Operating conditions	
Ambient temperature	[°C] -30...80
Mechanical data	
Weight	[g] 602.5
Top flange diameter	[mm] 102
ISO top flange type	F10
Shaft extension	M8
Materials	Mounting plate: plastics; metal parts: stainless steel (1.4301 / 304)
Remarks	
Pack quantity	1 pcs.