

PT9550

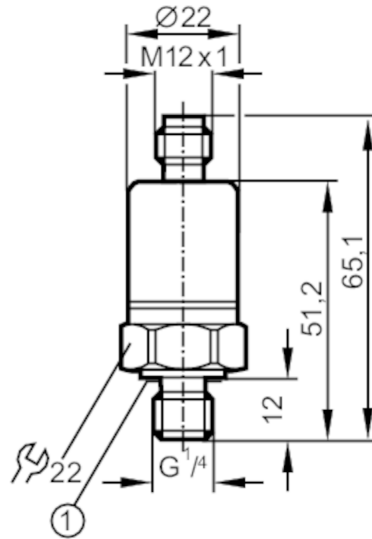

Pressure transmitter

PT-400-SBG14-B-DVG/US/ IW



- 1 Sealing
Tightening torque 25 Nm



Product characteristics

Output signal	analogue signal		
Measuring range	0...400 bar	0...5800 psi	0...40 MPa
Process connection	threaded connection G 1/4 external thread		

Application

Application	for mobile applications		
Media	liquids and gases		
Medium temperature [°C]	-25...90; (on request: -40...100 °C)		
Pressure rating	600 bar	8700 psi	60 MPa
Min. bursting pressure	1600 bar	23200 psi	160 MPa
Type of pressure	relative pressure		

Electrical data

Operating voltage [V]	16...36 DC		
Current consumption [mA]	< 6		
Min. insulation resistance [MΩ]	100; (80 V DC)		
Protection class	III		
Reverse polarity protection	yes		

Inputs / outputs

Number of inputs and outputs	Number of analogue outputs: 1
------------------------------	-------------------------------

Outputs

Total number of outputs	1
Output signal	analogue signal
Number of analogue outputs	1
Analogue voltage output [V]	0...10
Min. load resistance [Ω]	2000

PT9550



Pressure transmitter

PT-400-SBG14-B-DVG/US/ W

Measuring/setting range		
Measuring range	0...400 bar	0...5800 psi
		0...40 MPa
Accuracy / deviations		
Repeatability [% of the span]	< ± 0,1; (with temperature fluctuations < 10 K)	
Characteristics deviation [% of the span]	< ± 1,0; (incl. drift when overtightened, zero point and span error)	
Linearity deviation [% of the span]	< ± 0,25 (BFSL) / < ± 0,5 (LS)	
Hysteresis deviation [% of the span]	< ± 0,2	
Long-term stability [% of the span]	< ± 0,1; (per 6 months)	
Temperature coefficient zero point [% of the span / 10 K]	< ± 0,1; (-25...90 °C)	
Temperature coefficient span [% of the span / 10 K]	< ± 0,1; (-25...90 °C)	
Response times		
Step response time analogue output [ms]	8	
Operating conditions		
Ambient temperature [°C]	-25...90	
Storage temperature [°C]	-40...100	
Protection	IP 67; IP 69K	
Tests / approvals		
EMC	EN 61000-4-2 ESD immunity	4 kV CD / 8 kV AD according to the automotive directive 1995/54/EC, 2004/104 EC, 2005/83/EC
	ISO 11452-2	100 V/m
	ISO 11452-4	100 mA / severity level 4
	ISO 7637-2	severity level 4
	radiation of interference	CISPR 25
	EN 61000-6-1	
	EN 61000-6-4	
Shock resistance	DIN IEC 68-2-27	50 g (11 ms)
Vibration resistance	DIN IEC 68-2-6	20 g (10...2000 Hz)
MTTF [years]	1069	
Pressure Equipment Directive	Sound engineering practice; can be used for group 2 fluids; group 1 fluids on request	
Mechanical data		
Weight [g]	83	
Materials	stainless steel (1.4404 / 316L); PA	
Materials (wetted parts)	stainless steel (1.4404 / 316L); FKM	
Min. pressure cycles	50 million	
Process connection	threaded connection G 1/4 external thread	
Restrictor element integrated	yes	

PT9550



Pressure transmitter

PT-400-SBG14-B-DVG/US/ IW

Remarks	
Remarks	BFSL = Best Fit Straight Line LS = limit value setting
Pack quantity	1 pcs.

Electrical connection

Connector: 1 x M12



Connection

