



Part no.: 50040229
BCL 8 SM 100
Stationary bar code reader



Figure can vary



Contents

- Technical data
- Dimensioned drawings
- Electrical connection
- Diagrams
- Operation and display
- Part number code
- Notes
- Accessories

Technical data

Basic data	
Series	BCL 8
Functions	
Functions	Alignment mode AutoConfig AutoReflAct Daisy Chain I/O LED indicator Multiple read Output format selectable Reading gate control Reference code comparison
Read data	
Code types, readable	2/5 Interleaved Codabar Code 128 Code 39 Code 93 EAN 128 EAN 8/13 EAN Addendum Pharma Code Pharmacode (available upon consultation) UPC
Scanning rate, typical	600 scans/s
Bar codes per reading gate, max. number	63 Piece(s)
Optical data	
Reading distance	25 ... 145 mm
Light source	Laser , Red
Laser light wavelength	655 nm
Laser class	2 , IEC / EN 60825-1:2014
Transmitted-signal shape	Continuous
Usable opening angle (reading field opening)	60 °
Modulus size	0.15 ... 0.5 mm
Reading method	Line scanner
Scanning rate	600 scans/s
Beam deflection	Via rotating polygon wheel
Light beam exit	Lateral with deflecting mirror
Electrical data	
Protective circuit	Short circuit protected
Performance data	
Supply voltage U_B	4.75 ... 5.5 V , DC
Current consumption, max.	250 mA

Part no.: 50040229 – BCL 8 SM 100 – Stationary bar code reader
Inputs/outputs selectable

Output current, max.	20 mA
Number of inputs/outputs selectable	1 Piece(s)
Voltage type, outputs	DC
Switching voltage, outputs	Typ. $U_B / 0\text{ V}$
Voltage type, inputs	DC
Switching voltage, inputs	Max. 24 V DC Typ. $U_B / 0\text{ V}$
Input current, max.	20 mA

Input/output 1

Function	Freely configurable
----------	---------------------

Interface

Type	RS 232
RS 232	
Function	Process
Transmission speed	4,800 ... 57,600 Bd
Data format	Adjustable
Start bit	1
Data bit	7,8
Stop bit	1.2
Parity	Adjustable
Transmission protocol	Adjustable
Data encoding	ASCII HEX

Service interface

Type	RS 232
RS 232	
Function	Service

Connection

Number of connections	1 Piece(s)
Connection 1	
Function	Data interface PWR / SW IN/OUT
Type of connection	Connector
Thread size	M12
Type	Male
Material	Metal
No. of pins	5 -pin
Encoding	A-coded

Mechanical data

Design	Cubic
Dimension (W x H x L)	58 mm x 75 mm x 17.4 mm
Housing material	Metal , Zinc
Lens cover material	Glass
Net weight	120 g
Housing color	Red

Part no.: 50040229 – BCL 8 SM 100 – Stationary bar code reader

Type of fastening	Dovetail grooves Mounting thread Through-hole mounting Via optional mounting device
-------------------	--

Operation and display

Type of display	LED
Number of LEDs	2 Piece(s)

Environmental data

Ambient temperature, operation	0 ... 40 °C
Ambient temperature, storage	-20 ... 60 °C
Relative humidity (non-condensing)	0 ... 90 %

Certifications

Degree of protection	IP 67
Protection class	III
Certifications	c UL US
Test procedure for EMC in accordance with standard	EN 61000-6-2, -3
Test procedure for shock in accordance with standard	IEC 60068-2-27, test Ea
Test procedure for vibration in accordance with standard	IEC 60068-2-6, test Fc
US patents	US 6,735,007 B US 6,822,774 B

Classification

Customs tariff number	84719000
eCl@ss 8.0	27280102
eCl@ss 9.0	27280102
ETIM 5.0	EC002550
ETIM 6.0	EC002550

Dimensioned drawings

All dimensions in millimeters

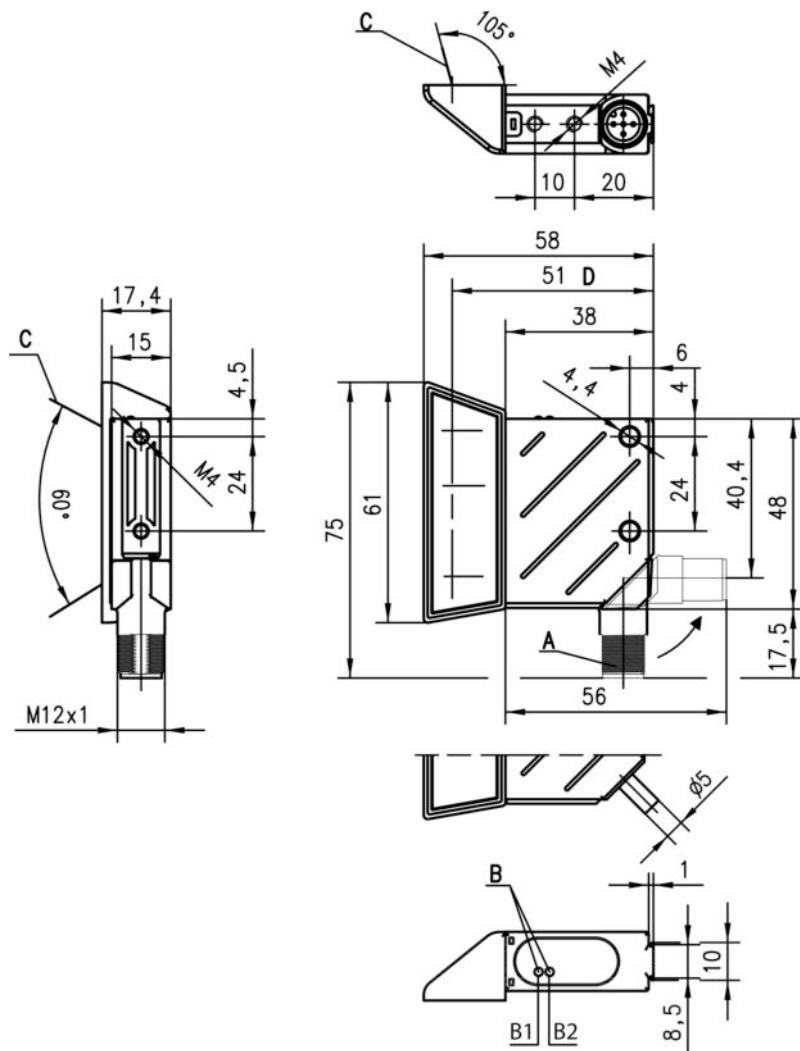

- A Turning connector, turnable by 90°
- B1 Status LED
- B2 Decode LED
- C Laser beam
- D Optical axis

Electrical connection

Connection 1	
Function	Data interface PWR / SW IN/OUT
Type of connection	Connector
Thread size	M12
Type	Male
Material	Metal
No. of pins	5 -pin
Encoding	A-coded

Pin	Pin assignment
1	+5 V DC
2	RS 232 TxD
3	GND
4	RS 232 RxD
5	SW IN/OUT

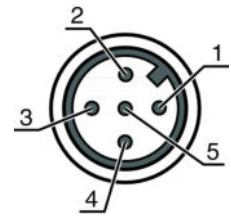

Diagrams

Reading field curve

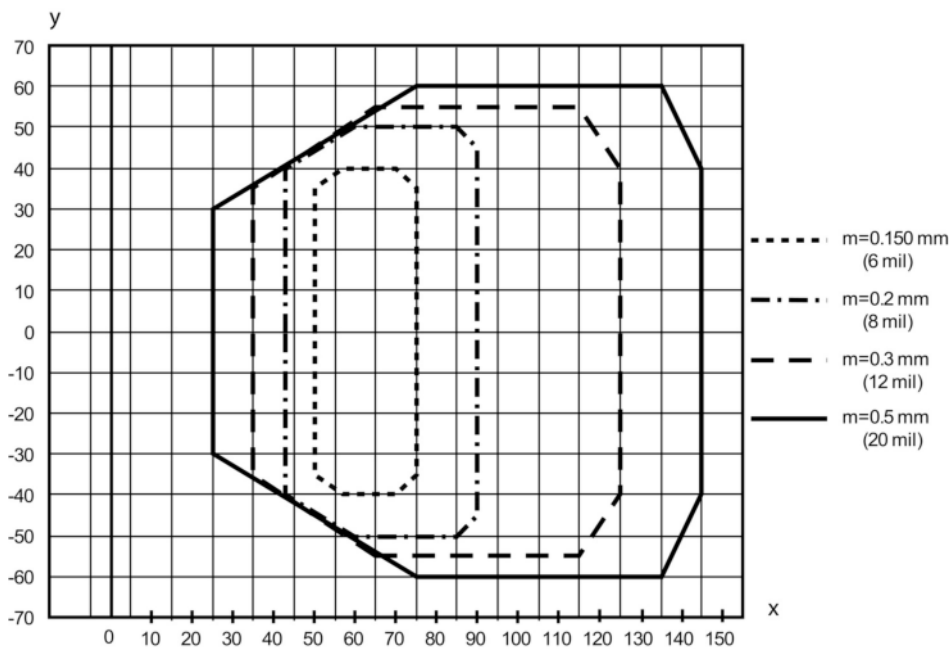

x Reading field distance [mm]
 y Reading field width [mm]

Operation and display

LEDs

LED	Display	Meaning
1	Green, flashing	Device ok, initialization phase
	Green, continuous light	Operational readiness
	Red, flashing	Device OK, warning set
	Red, continuous light	Device error
	Orange, flashing	Service operation
2	Green, continuous light	Reading successful
	Red, continuous light	No reading result
	Orange, continuous light	Reading gate active

Part no.: 50040229 – BCL 8 SM 100 – Stationary bar code reader

Part number code

Part designation:

BCL	Operating principle: BCL: bar code reader
X	Series/interface (integrated fieldbus technology): 8: RS 232
Y	Scanning principle: S: line scanner (single line)
Z	Optics: M: Medium Density (medium distance) N: High Density (close)
A	Electrical connection: 5: cable, 5 wires 1: M12 connector, 5-pin (plug)
B	Cable length: 5: 2000 mm 0: N/A
C	Beam exit: 0: Perpendicular 2: Front

Note

A list with all available device types can be found on the Leuze website at www.leuze.com.

Notes

Observe intended use!

- This product is not a safety sensor and is not intended as personnel protection.
- The product may only be put into operation by competent persons.
- Only use the product in accordance with its intended use.

For UL applications:

- For UL applications, use is only permitted in Class 2 circuits in accordance with the NEC (National Electric Code).

WARNING! LASER RADIATION – CLASS 2 LASER PRODUCT

Do not stare into beam!

The device satisfies the requirements of IEC/EN 60825-1:2014 safety regulations for a product of **laser class 2** as well as the U.S. 21 CFR 1040.10 regulations with deviations corresponding to "Laser Notice No. 56" from May 08, 2019.

- Never look directly into the laser beam or in the direction of reflected laser beams! If you look into the beam path over a longer time period, there is a risk of injury to the retina.
- Do not point the laser beam of the device at persons!
- Interrupt the laser beam using a non-transparent, non-reflective object if the laser beam is accidentally directed towards a person.
- When mounting and aligning the device, avoid reflections of the laser beam off reflective surfaces!
- CAUTION! Use of controls or adjustments or performance of procedures other than specified herein may result in hazardous light exposure.
- Observe the applicable statutory and local laser protection regulations.
- The device must not be tampered with and must not be changed in any way.
There are no user-serviceable parts inside the device.
Repairs must only be performed by Leuze electronic GmbH + Co. KG.
- If the scanner motor fails during the emission of laser radiation, the limit value of laser class 2 in accordance with IEC 60825-1:2014 could be exceeded. The device has safeguards to prevent this occurrence.
- If the emitted laser beam is at a standstill, immediately disconnect the faulty bar code reader from the voltage supply.
- The BCL8 emits scanned optical radiation at a wavelength of 655 nm (red).
- Looking at the device's mirror and operating at the lowest scanning rate (500 scans/s) at a viewing distance of 100 mm results in pulses with a pulse duration shorter than 420 µs on the retina of the eye. The total pulse peak power at the exit window is less than 1.7 mW.
- The average laser power is less than 1 mW in accordance with laser class 2 acc. to IEC 60825-1:2014

NOTE



Affix laser information and warning signs!

Laser information and warning signs are affixed to the device. In addition, self-adhesive laser information and warning signs (stick-on labels) are supplied in several languages.

- Affix the laser information sheet to the device in the language appropriate for the place of use. When using the device in the US, use the stick-on label with the "Complies with 21 CFR 1040.10" note.
- Affix the laser information and warning signs near the device if no signs are attached to the device (e.g. because the device is too small) or if the attached laser information and warning signs are concealed due to the installation position.
- Affix the laser information and warning signs so that they are legible without exposing the reader to the laser radiation of the device or other optical radiation.



Accessories

Connection technology - Connection unit

	Part no.	Designation	Article	Description
	50104790	MA 8-01	Modular connection unit	Supply voltage: 10 ... 30 V Current consumption, max.: 50 mA Interface: RS 485 Connections: 3 Piece(s) Degree of protection: IP 67
	50101699	MA 8.1	Modular connection unit	Supply voltage: 10 ... 30 V Current consumption, max.: 50 mA Interface: RS 232 Connections: 3 Piece(s) Degree of protection: IP 67

Part no.: 50040229 – BCL 8 SM 100 – Stationary bar code reader

Connection technology - Connection cables

	Part no.	Designation	Article	Description
	50040757	KB 008-3000 A	Connection cable	Connection 1: Connector, M12, Axial, Female, A-coded, 5 -pin Connection 2: Open end Shielded: Yes Cable length: 3,000 mm Sheathing material: PUR
	50101941	KB-008-3000 A-S	Connection cable	Connection 1: Connector, M12, Axial, Male, A-coded, 5 -pin Connection 2: Open end Shielded: Yes Cable length: 3,000 mm Sheathing material: PUR

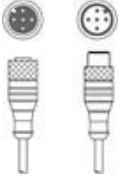

Connection technology - Interconnection cables

	Part no.	Designation	Article	Description
	50133891	KDS S-M12-5A-M12-5A-P1-030	Interconnection cable	Connection 1: Connector, M12, Axial, Female, A-coded, 5 -pin Connection 2: Connector, M12, Axial, Male, A-coded, 5 -pin Shielded: Yes Cable length: 3,000 mm Sheathing material: PUR

Mounting technology - Rod mounts

	Part no.	Designation	Article	Description
	50127177	BTU 008M-D10	Mounting system	Design of mounting device: Mounting system Fastening, at system: Sheet-metal mounting, For 10 mm rod Mounting bracket, at device: Screw type Type of mounting device: Turning, 360°, Adjustable, Clampable Material: Metal

Mounting technology - Other

	Part no.	Designation	Article	Description
	50036196	BT 8-0	Mounting device	Design of mounting device: Mounting clamp Fastening, at system: Mounting thread Mounting bracket, at device: Clampable Type of mounting device: Rigid Material: Metal
	50104791	BT 8-01	Mounting device	Fastening, at system: Through-hole mounting Mounting bracket, at device: Screw type Material: Metal

Part no.: 50040229 – BCL 8 SM 100 – Stationary bar code reader

Note

A list with all available accessories can be found on the Leuze electronic website in the Download tab of the article detailed page.