

M23 FEMALE, 90° 12 POLE

PUR 8x0,34+3X0.75 GRAY, drag ch 30m

M23

Female 90°

12-pole

11-pole used

for 8-way distribution box, 4-pole

Further cable lengths on request. Plastic housings with good resistance against chemicals and oils. The resistance to aggressive media should be individually tested for your application. Further details on request.

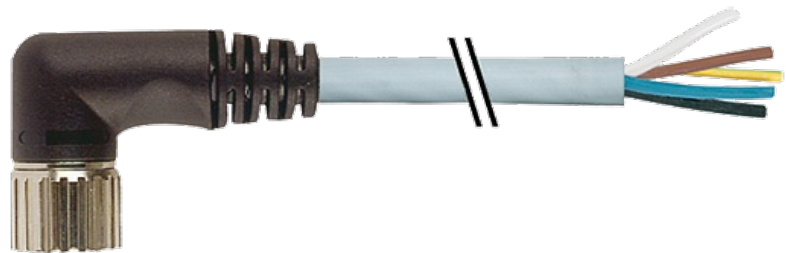
[Link to Product](#)**Illustration**

1	white
2	green
3	yellow
4	gray
5	pink
6	red
7	black
8	violet
8	brown 0.75 mm ²
11	blue 0.75 mm ²
9	green/yellow 0.75 mm ²
12	

Female

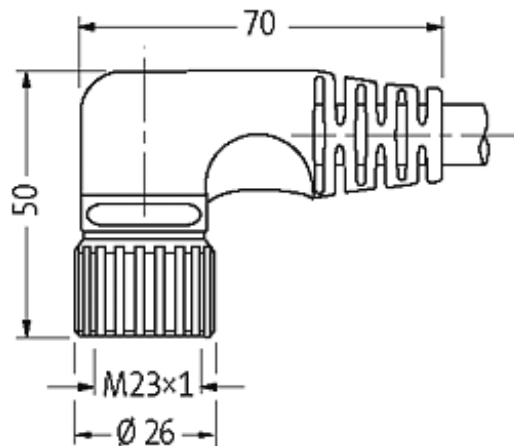
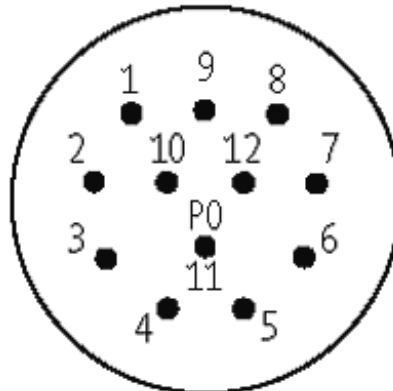

Product may differ from Image

Form

23151

Technical Data

Operating voltage	max. 125 V AC/DC
Operating current per contact	max. 10 A
Locking of ports	Screw thread M23 × 1 mm
Protection	IP67 inserted and tightened (EN 60529)

Cables

Cable number	362
No./diameter of wires	8×0.34 + 3×0.75 mm ²
Wire isolation	PVC
C-track properties	2 Mio.
Jacket Color	gray
Shore hardness outer jacket	85 ± 5A
Material (jacket)	PUR/PVC
Outer diameter	approx. 9.1 mm
Bend radius (fixed)	10 × outer Ø

The information in this brochure has been compiled with the utmost care.

Liability for the correctness completeness and topicality of the information is restricted to gross negligence. Version: 05/15

Bend radius (moving)	12 × outer Ø
Temperature range (fixed)	-30...+80 °C
Temperature range (mobile)	-5...+80 °C

Commercial data

country of origin	DE
customs tariff number	85444290
minimum order quantity	1