

Serial EEPROM Series Standard EEPROM

## Plug & Play EEPROM

# BR34E02-3

### General Description

BR34E02-3 is 256 × 8 bit Electrically Erasable PROM (Based on Serial Presence Detect)

### Features

- 256 × 8 bit Architecture Serial EEPROM
- Wide Operating Voltage Range: 1.7V to 5.5V
- Two-Wire Serial Interface
- Self-Timed Erase and Write Cycle
- Page Write Function (16byte)
- Write Protect Mode
  - Settable Reversible Write Protect Function : 00h-7Fh
  - Write Protect 1 (Onetime Rom) : 00h-7Fh
  - Write Protect 2 (Hardwire WP PIN) : 00h-FFh
- Low Power consumption
  - Write (at 1.7V) : 0.4mA (typ)
  - Read (at 1.7V) : 0.1mA (typ)
  - Standby (at 1.7V) : 0.1µA (typ)
- Prevention of Write Mistake
  - Write Protect Feature (WP pin)
  - Prevention of Write Mistake at Low Voltage
- High Reliability Fine Pattern CMOS Technology
- More than 1 million write cycles
- More than 40 years data retention
- Noise Reduction Filtered Inputs in SCL / SDA
- Initial delivery state FFh

### Packages W(Typ) x D(Typ) x H(Max)

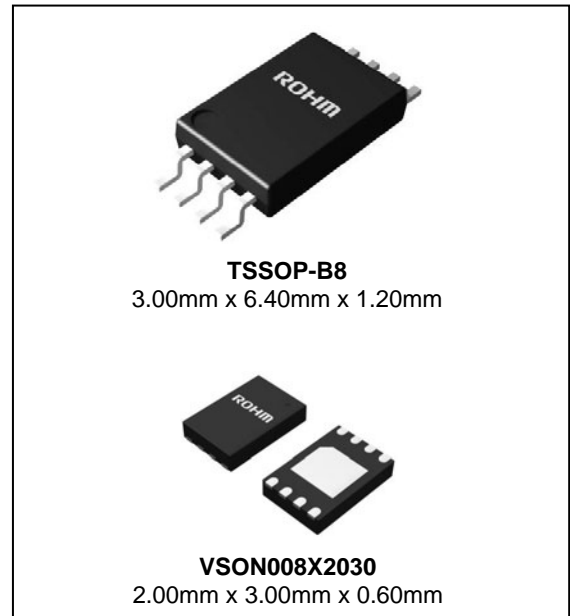

### BR34E02-3

Capacity	Bit Format	Type	Power Source Voltage	Package
2Kbit	256x8	BR34E02FVT-3	1.7V to 5.5V	TSSOP-B8
		BR34E02NUX-3		VSON008X2030

### Absolute Maximum Ratings (Ta=25°C)

Parameter	Symbol	Rating	Unit	Remark
Supply Voltage	Vcc	-0.3 to +6.5	V	
Power Dissipation	Pd	330 (TSSOP-B8)	mW	Derate by 3.3mW/°C when operating above Ta=25°C
		300 (VSON008X2030)		Derate by 3.0mW/°C when operating above Ta=25°C
Storage Temperature	Tstg	-65 to +125	°C	
Operating Temperature	Topr	-40 to +85	°C	
Input Voltage / Output Voltage (A0)	-	-0.3 to 10.0	V	
Input Voltage / Output Voltage (others)	-	-0.3 to Vcc+1.0	V	
Electrostatic discharge voltage (human body model)	VESD	-4000 to +4000	V	

### Memory Cell Characteristics (Ta=25°C, Vcc=1.7V to 5.5V)

Parameter	Limit			Unit
	Min	Typ	Max	
Write / Erase Cycle <sup>(1)</sup>	1,000,000	-	-	Times
Data Retention <sup>(1)</sup>	40	-	-	Years

(1) Not 100% TESTED

○Product structure : Silicon monolithic integrated circuit ○This product has no designed protection against radioactive rays

## Recommended Operating Ratings

Parameter	Symbol	Rating	Unit
Supply Voltage	$V_{CC}$	1.7 to 5.5	V
Input Voltage	$V_{IN}$	0 to $V_{CC}$	V

DC Characteristics (Unless otherwise specified  $T_a = -40^{\circ}\text{C}$  to  $+85^{\circ}\text{C}$ ,  $V_{CC} = 1.7\text{V}$  to  $5.5\text{V}$ )

Parameter	Symbol	Limit			Unit	Test Conditions
		Min	Typ	Max		
Input High Voltage	$V_{IH}$	0.7 $V_{CC}$	-	$V_{CC}+1.0$	V	
Input Low Voltage	$V_{IL}$	-0.3	-	0.3 $V_{CC}$	V	
Output Low Voltage 1	$V_{OL1}$	-	-	0.4	V	$I_{OL}=2.1\text{mA}$ , $2.5\text{V} \leq V_{CC} \leq 5.5\text{V}(\text{SDA})$
Output Low Voltage 2	$V_{OL2}$	-	-	0.2	V	$I_{OL}=0.7\text{mA}$ , $1.7\text{V} \leq V_{CC} < 2.5\text{V}(\text{SDA})$
Input Leakage Current 1	$I_{LI1}$	-1	-	1	$\mu\text{A}$	$V_{IN}=0\text{V}$ to $V_{CC}$ (A0, A1, A2, SCL)
Input Leakage Current 2	$I_{LI2}$	-1	-	15	$\mu\text{A}$	$V_{IN}=0\text{V}$ to $V_{CC}$ (WP)
Input Leakage Current 3	$I_{LI3}$	-1	-	20	$\mu\text{A}$	$V_{IN}=V_{HV}(\text{A0})$
Output Leakage Current	$I_{LO}$	-1	-	1	$\mu\text{A}$	$V_{OUT}=0\text{V}$ to $V_{CC}$
Supply Current (Write)	$I_{CC1}$	-	-	2.0	mA	$V_{CC}=5.5\text{V}$ , $f_{SCL}=400\text{kHz}$ , $t_{WR}=5\text{ms}$ Byte Write Page Write Write Protect
Supply Current (Read)	$I_{CC2}$	-	-	0.5	mA	$V_{CC}=5.5\text{V}$ , $f_{SCL}=400\text{kHz}$ Random Read Current Read Sequential Read
Standby Current	$I_{SB}$	-	-	2.0	$\mu\text{A}$	$V_{CC}=5.5\text{V}$ , SDA, SCL= $V_{CC}$ A0, A1, A2=GND, WP=GND
A0 HV Voltage	$V_{HV}$	7	-	10	V	$V_{HV}-V_{CC} \geq 4.8\text{V}$

AC Characteristics (Unless otherwise specified  $T_a = -40^{\circ}\text{C}$  to  $+85^{\circ}\text{C}$ ,  $V_{CC} = 1.7\text{V}$  to  $5.5\text{V}$ )

Parameter	Symbol	Limit			Unit
		Min	Typ	Max	
Clock Frequency	$f_{SCL}$	-	-	400	kHz
Data Clock High Period	$t_{HIGH}$	0.6	-	-	$\mu\text{s}$
Data Clock Low Period	$t_{LOW}$	1.2	-	-	$\mu\text{s}$
SDA and SCL Rise Time <sup>(1)</sup>	$t_R$	-	-	0.3	$\mu\text{s}$
SDA and SCL Fall Time <sup>(1)</sup>	$t_F$	-	-	0.3	$\mu\text{s}$
Start Condition Hold Time	$t_{HD:STA}$	0.6	-	-	$\mu\text{s}$
Start Condition Setup Time	$t_{SU:STA}$	0.6	-	-	$\mu\text{s}$
Input Data Hold Time	$t_{HD:DAT}$	0	-	-	ns
Input Data Setup Time	$t_{SU:DAT}$	100	-	-	ns
Output Data Delay Time	$t_{PD}$	0.1	-	0.9	$\mu\text{s}$
Output Data Hold Time	$t_{DH}$	0.1	-	-	$\mu\text{s}$
Stop Condition Setup Time	$t_{SU:STO}$	0.6	-	-	$\mu\text{s}$
Bus Free Time	$t_{BUF}$	1.2	-	-	$\mu\text{s}$
Write Cycle Time	$t_{WR}$	-	-	5	ms
Noise Spike Width (SDA and SCL)	$t_I$	-	-	0.1	$\mu\text{s}$
WP Hold Time	$t_{HD:WP}$	0	-	-	$\mu\text{s}$
WP Setup Time	$t_{SU:WP}$	0.1	-	-	$\mu\text{s}$
WP High Period	$t_{HIGH:WP}$	1.0	-	-	$\mu\text{s}$

(1) Not 100% TESTED

Serial Input / Output Timing

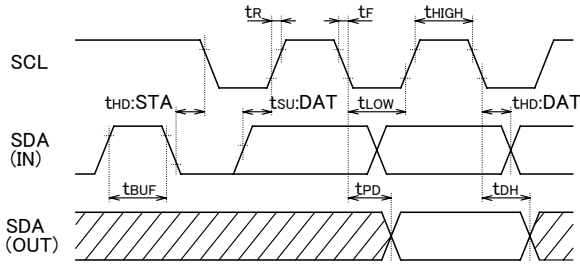

Figure 1-(a). Serial Input / Output Timing

OSDA data is latched into the chip at the rising edge of SCL clock.  
 OOutput data toggles at the falling edge of SCL clock.

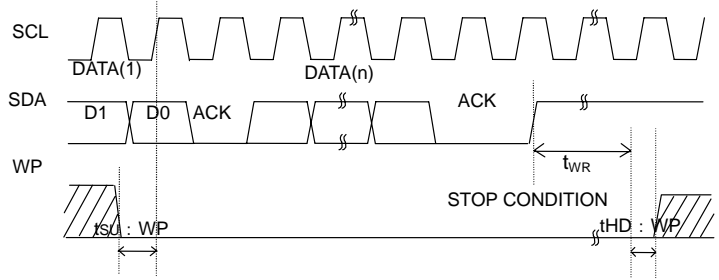

Figure 1-(d). WP Timing of the Write Operation

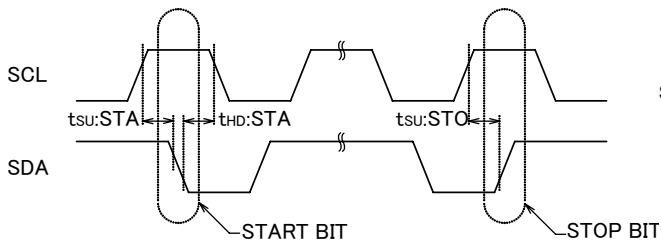

Figure 1-(b). Start/Stop Bit Timing

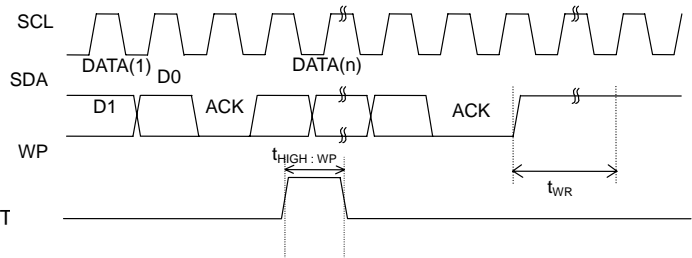

Figure 1-(e). WP Timing of the Write Cancel Operation

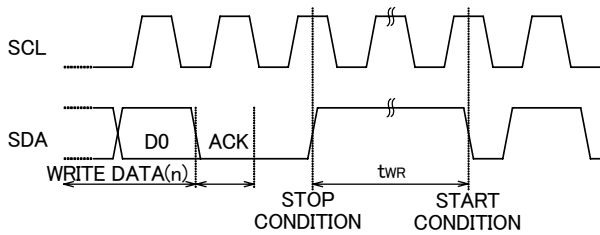
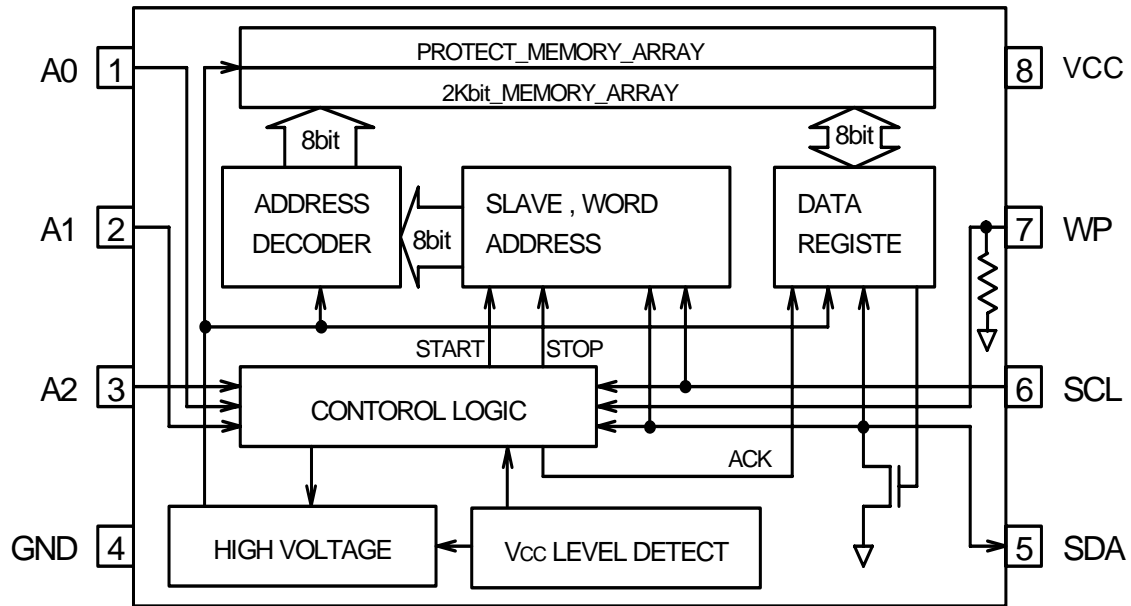

Figure 1-(c). Write Cycle Timing

OFor WRITE operation, WP must be "Low" from the rising edge of the clock (which takes in D0 of first byte) until the end of  $t_{WR}$ . (See Figure 1-(d) ) During this period, WRITE operation can be canceled by setting WP "High". (See Figure 1-(e))  
 OWhen WP is set to "High" during  $t_{WR}$ , WRITE operation is immediately ceased, making the data unreliable. It must then be re-written.

## Block Diagram



## Pin Configuration

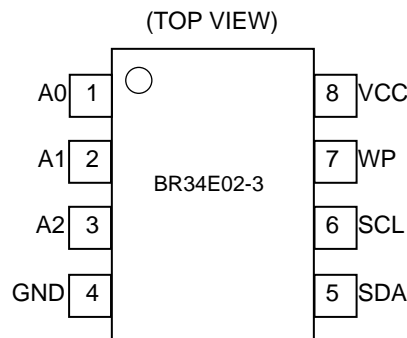

## Pin Descriptions

Pin Name	Input/Output	Descriptions
VCC	-	Power supply
GND	-	Ground 0V
A0, A1, A2	IN	Slave address set <sup>(1)</sup>
SCL	IN	Serial clock input
SDA	IN / OUT	Slave and word address <sup>(2)</sup> Serial data input, serial data output
WP	IN	Write protect input <sup>(3)</sup>

(1) A0, A1 and A2 are not allowed to use as open.

(2) Open drain output requires a pull-up resistor.

(3) WP Pin has a Pull-Down resistor. Please leave unconnected or connect to GND when not in use.

Typical Performance Curves

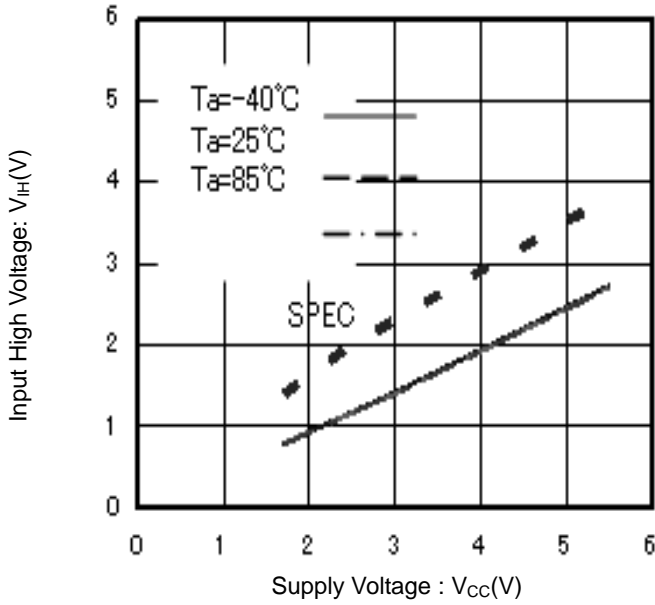

Figure 2. Input High Voltage vs Supply Voltage (A0, A1, A2, SCL, SDA, WP)

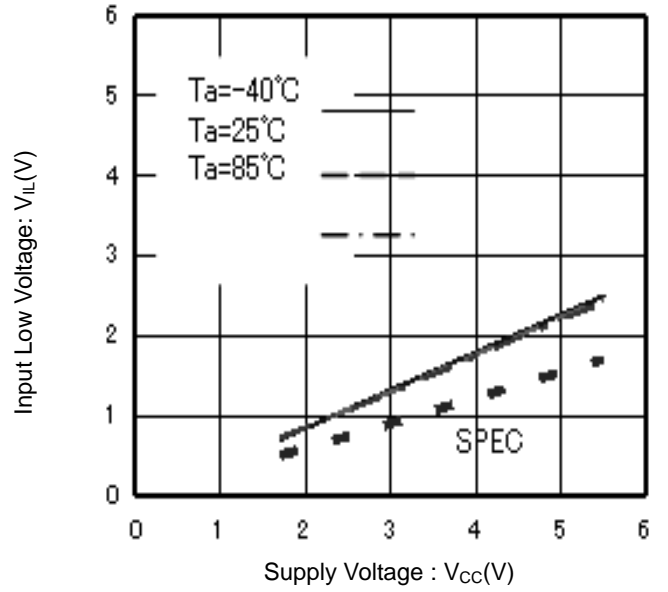

Figure 3. Input Low Voltage vs Supply Voltage (A0, A1, A2, SCL, SDA, WP)

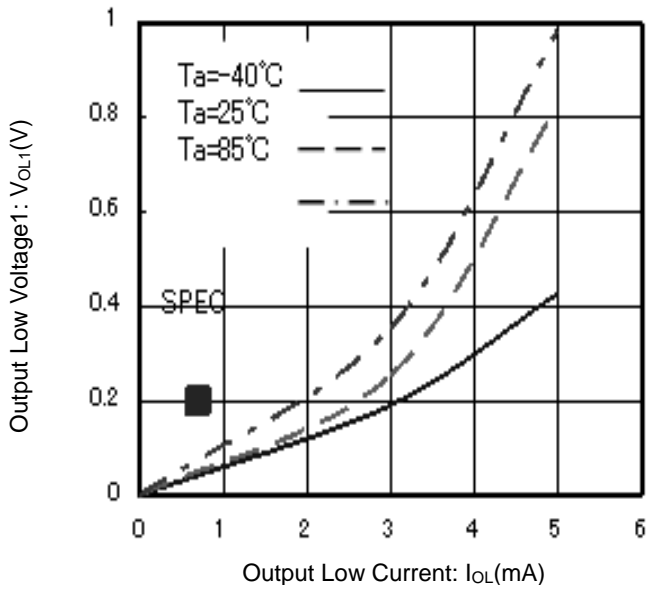

Figure 4. Output Low Voltage1 vs Output Low Current (V<sub>CC</sub>=2.5V)

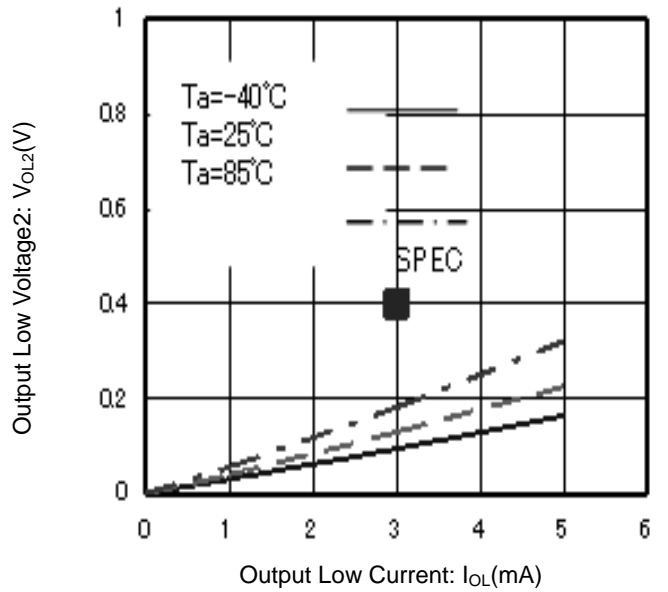

Figure 5. Output Low Voltage2 vs Output Low Current (V<sub>CC</sub>=1.7V)

Typical Performance Curves - Continued

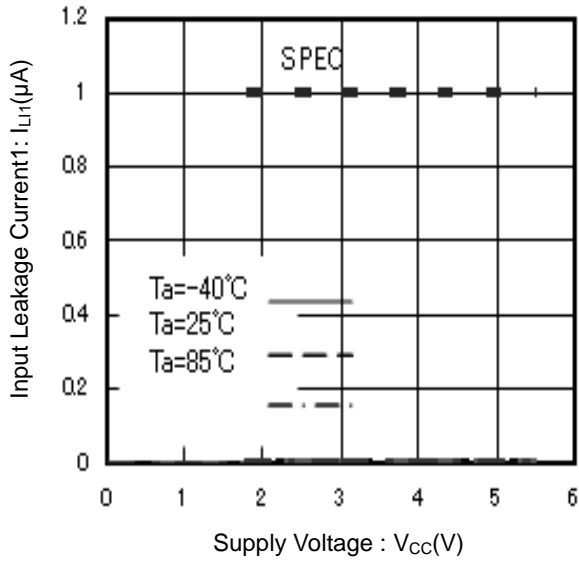

Figure 6. Input Leakage Current1 vs Supply Voltage (A0, A1, A2, SCL)

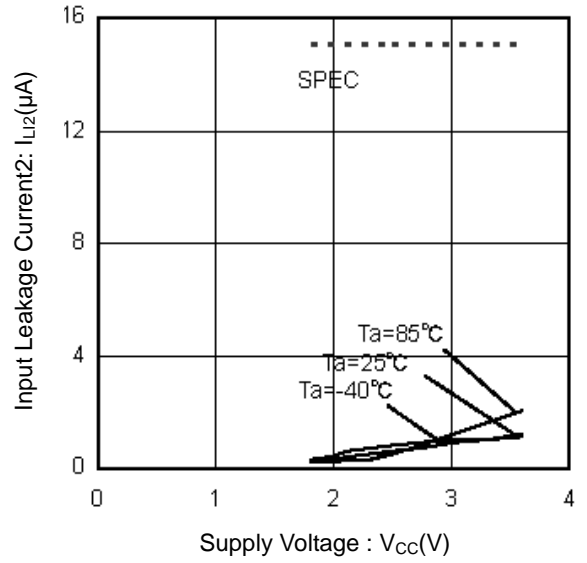

Figure 7. Input Leakage Current2 vs Supply Voltage (WP)

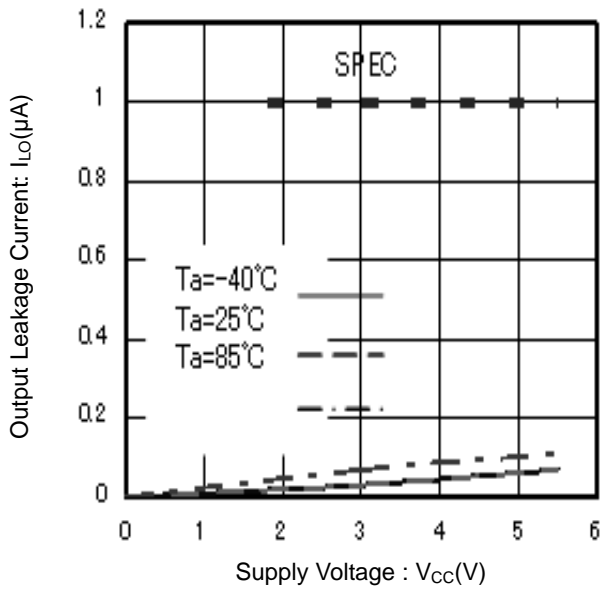

Figure 8. Output Leakage Current vs Supply Voltage (SDA)

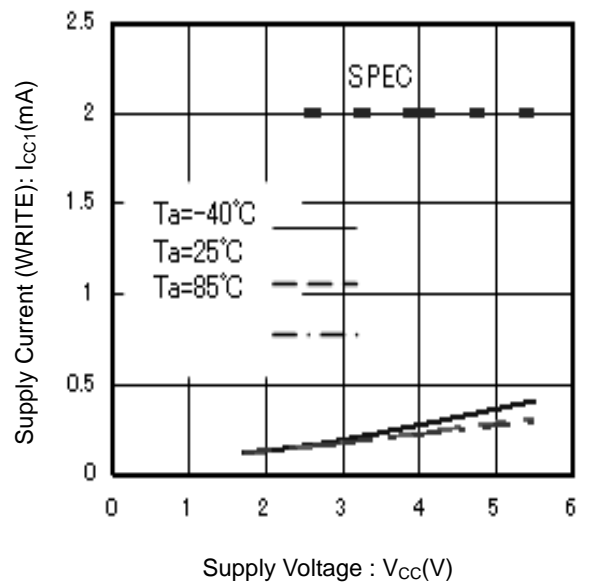

Figure 9. Supply Current (WRITE) vs Supply Voltage (fSCL=400kHz)

Typical Performance Curves - Continued

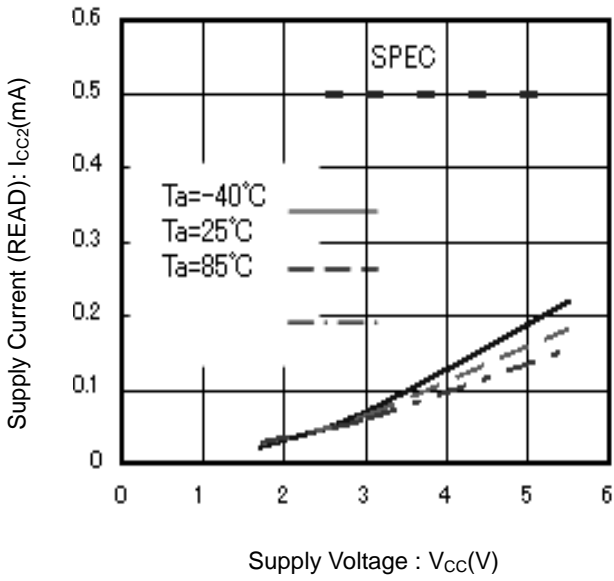

Figure 10. Supply Current (READ) vs Supply Voltage (f<sub>SCL</sub>=400kHz)

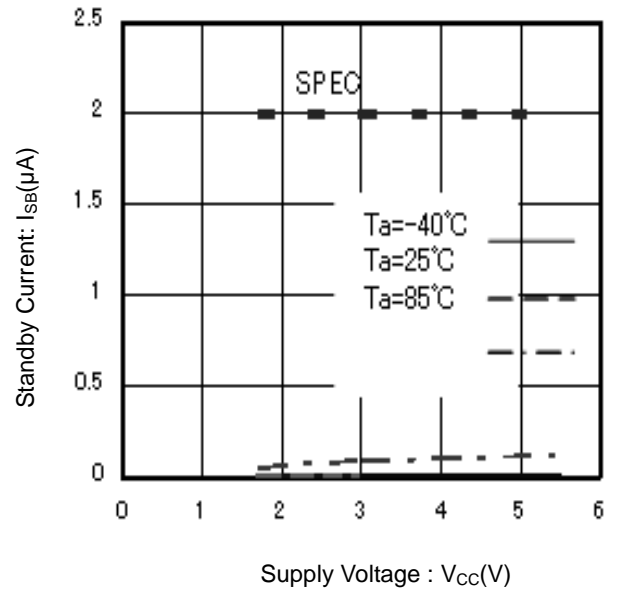

Figure 11. Standby Current vs Supply Voltage

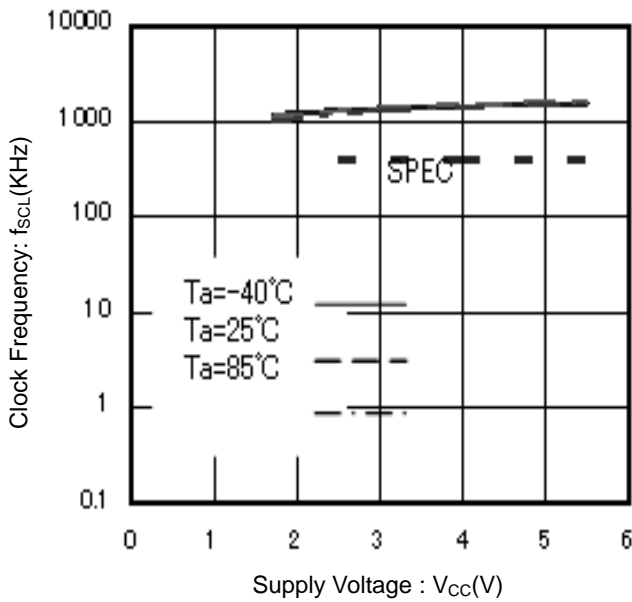

Figure 12. Clock Frequency vs Supply Voltage

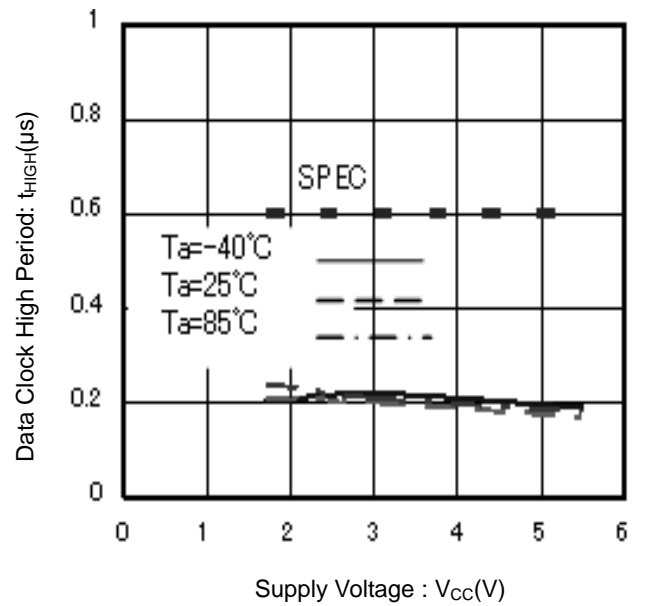

Figure 13. Data Clock High Period vs Supply Voltage

Typical Performance Curves - Continued

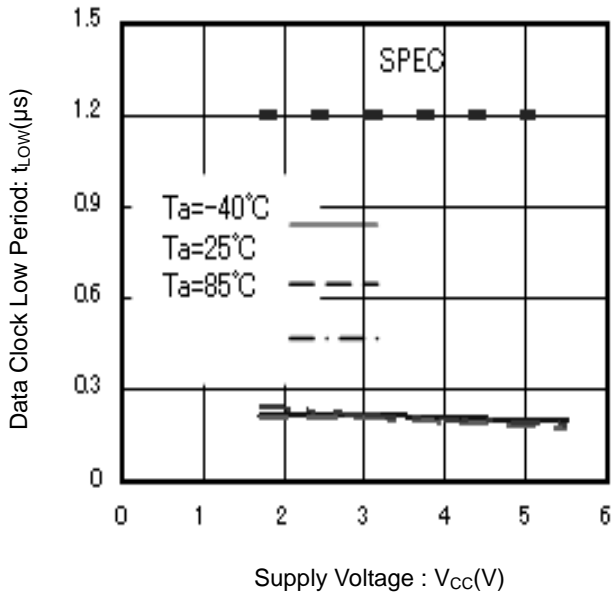

Figure 14. Data Clock Low Period vs Supply Voltage

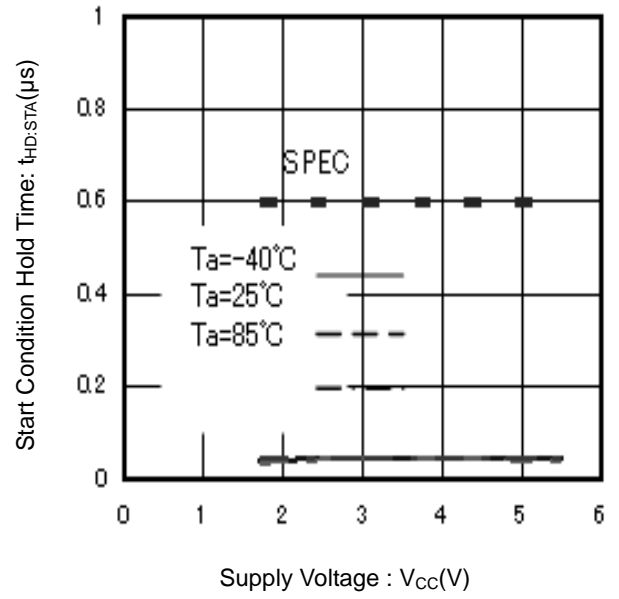

Figure 15. Start Condition Hold Time vs Supply Voltage

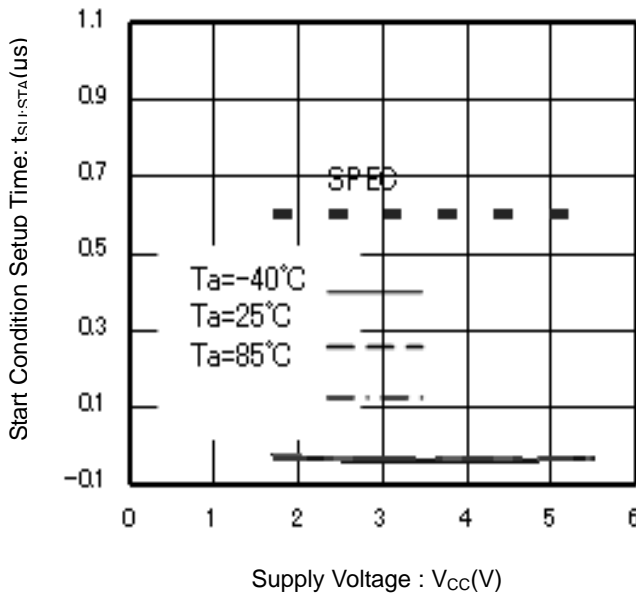

Figure 16. Start Condition Setup Time vs Supply Voltage

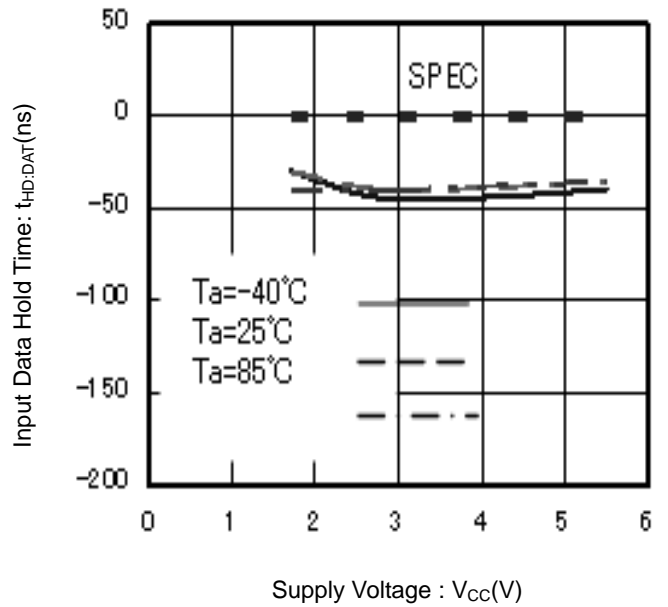

Figure 17. Input Data Hold Time vs Supply Voltage (HIGH)



Typical Performance Curves - Continued

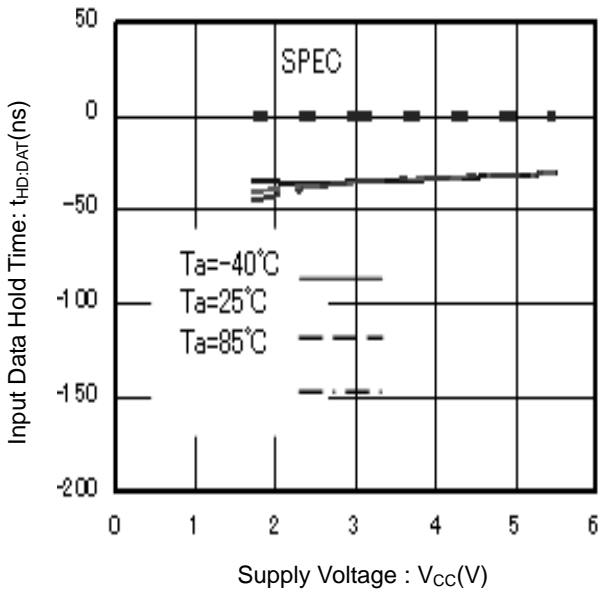

Figure 18. Input Data Hold Time vs Supply Voltage (LOW)

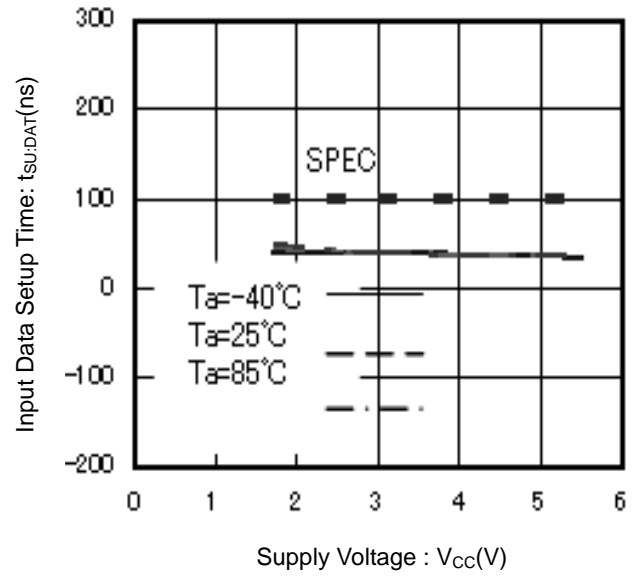

Figure 19. Input Data Setup Time vs Supply Voltage (HIGH)

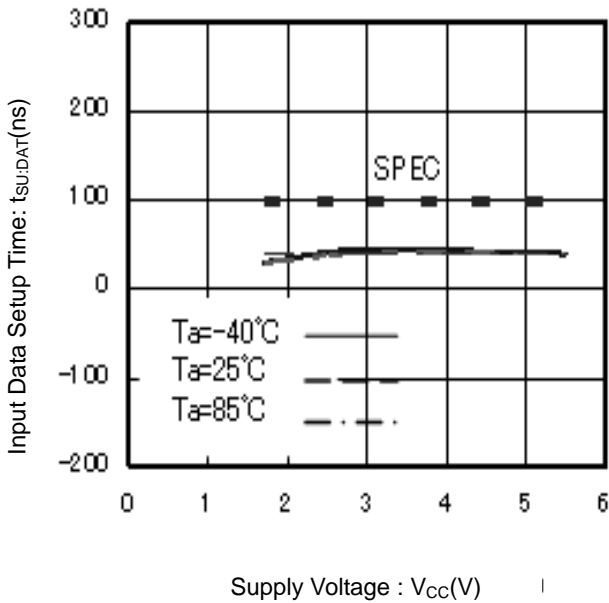

Figure 20. Input Data Setup Time vs Supply Voltage (LOW)

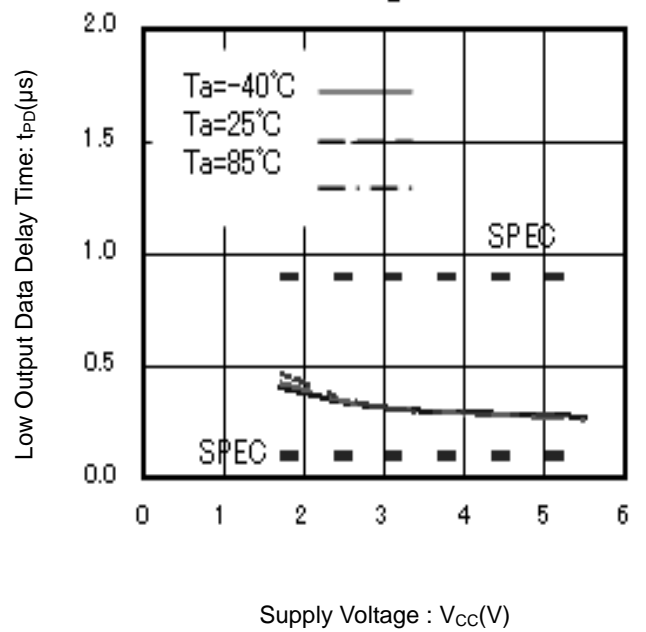

Figure 21. Low Output Data Delay Time vs Supply Voltage

Typical Performance Curves - Continued

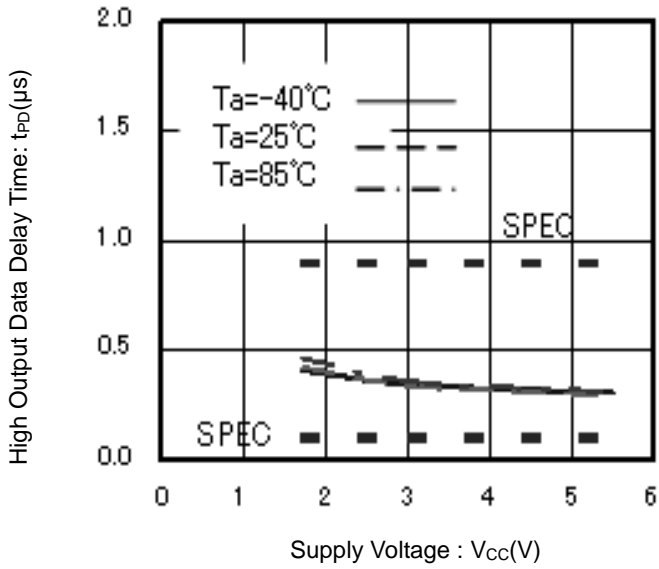

Figure 22. High Output Data Delay Time vs Supply Voltage

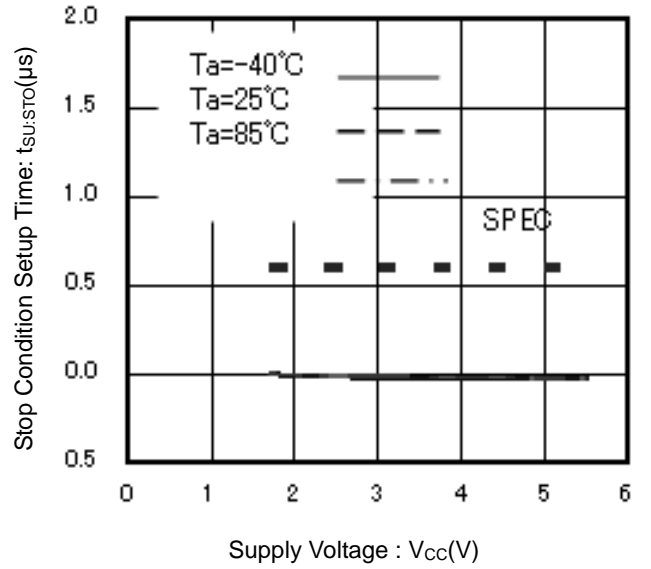

Figure 23. Stop Condition Setup Time vs Supply Voltage

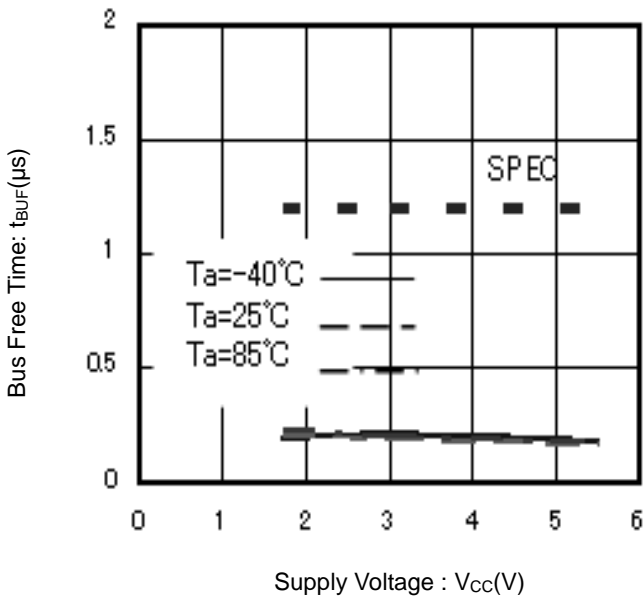

Figure 24. Bus Free Time vs Supply Voltage

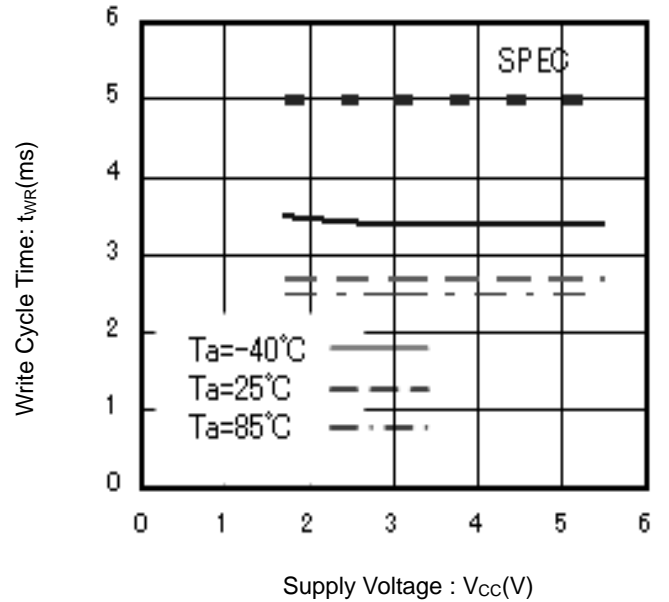

Figure 25. Write Cycle Time vs Supply Voltage

Typical Performance Curves - Continued

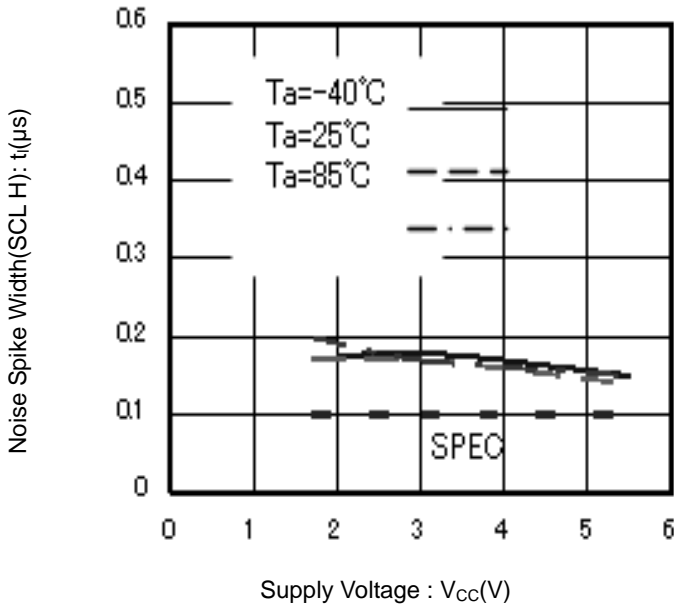

Figure 26. Noise Spike Width vs Supply Voltage (SCL H)

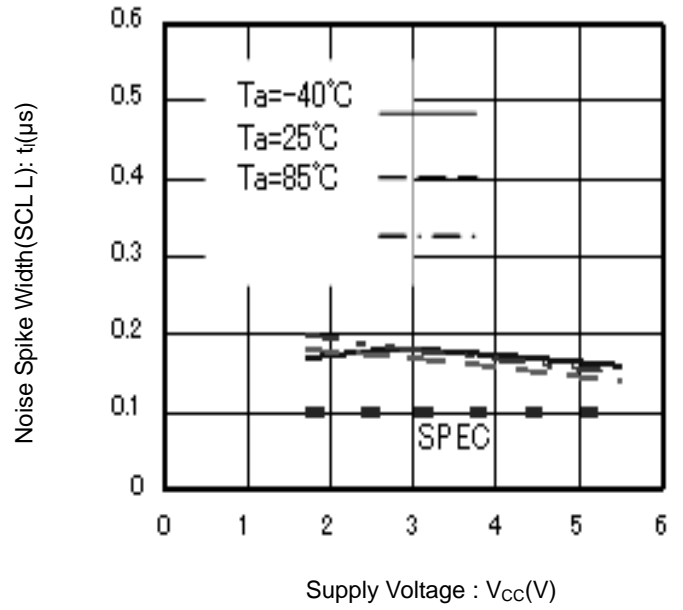

Figure 27. Noise Spike Width vs Supply Voltage (SCL L)

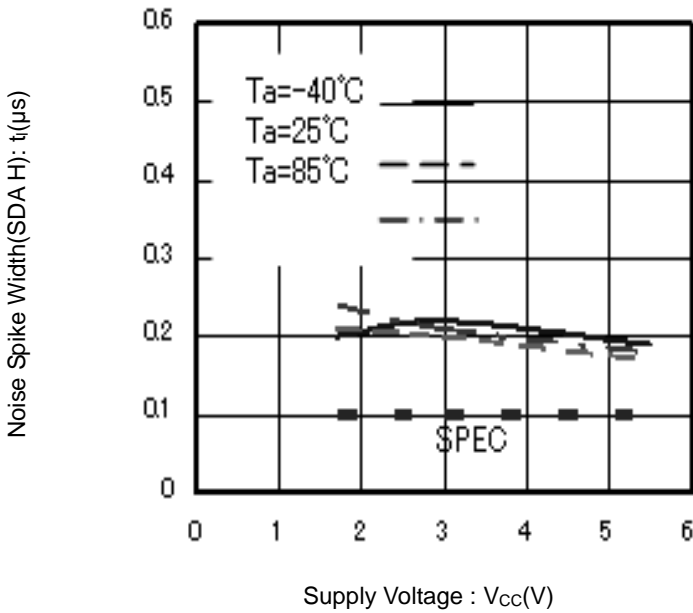

Figure 28. Noise Spike Width vs Supply Voltage (SDA H)

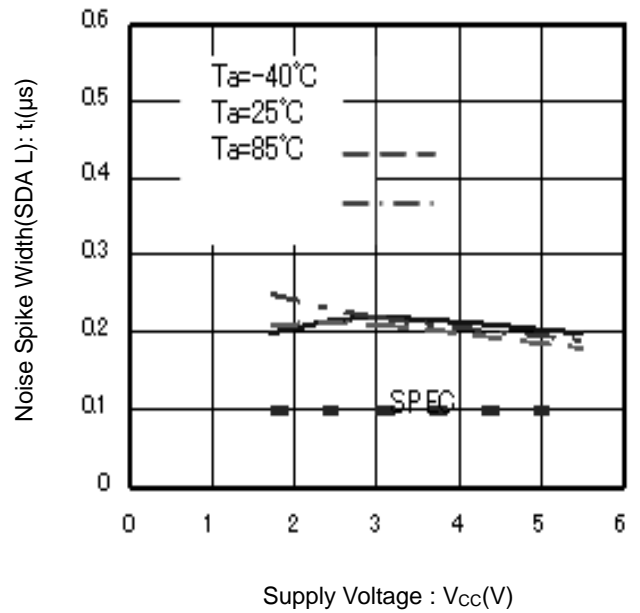

Figure 29. Noise Spike Width vs Supply Voltage (SDA L)

Typical Performance Curves - Continued

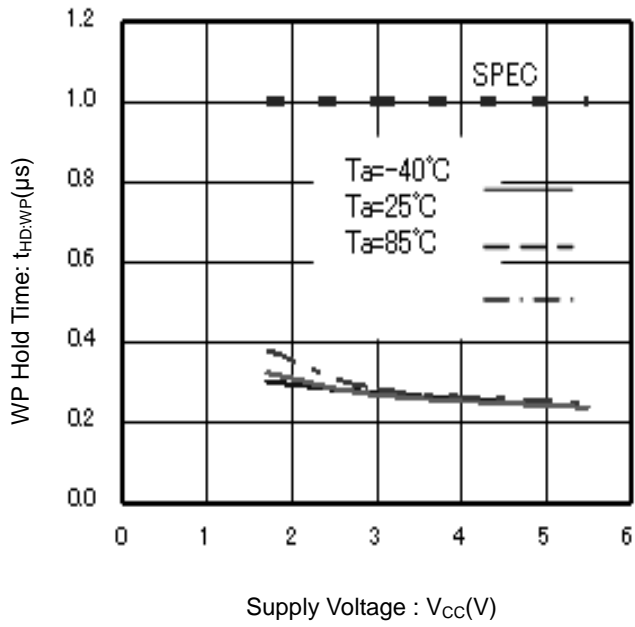

Figure 30. WP Hold Time vs Supply Voltage

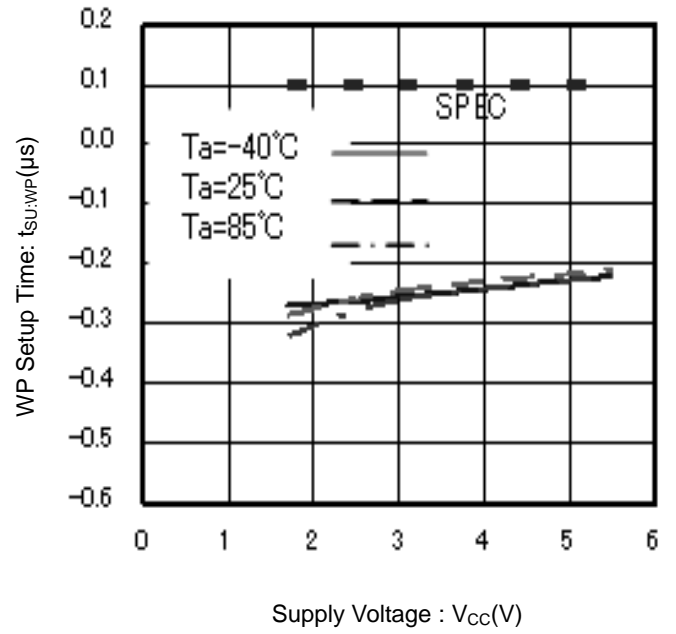

Figure 31. WP Setup Time vs Supply Voltage

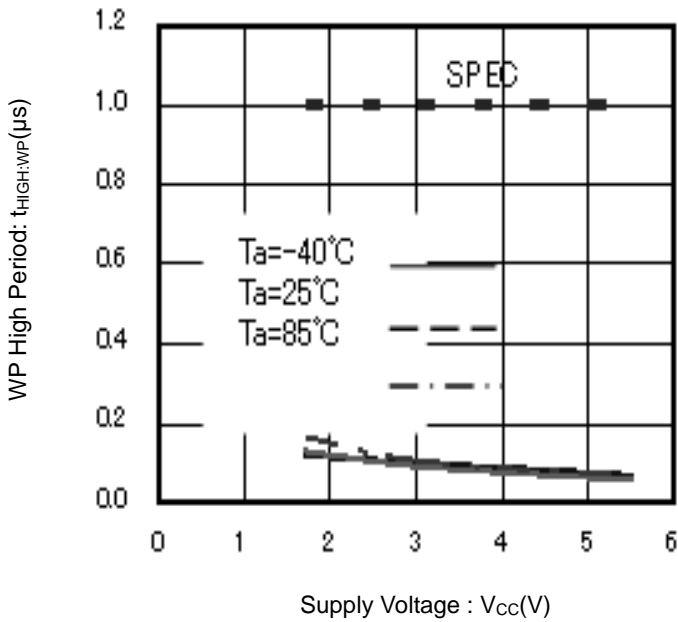

Figure 32. WP High Period vs Supply Voltage

## Timing Chart

### 1. I<sup>2</sup>C BUS Data Communication

I<sup>2</sup>C BUS data communication starts by start condition input, and ends by stop condition input. Data is always 8bit long, and acknowledge is always required after each byte. I<sup>2</sup>C BUS data communication with several devices is possible by connecting with 2 communication lines: serial data (SDA) and serial clock (SCL).

Among the devices, there should be a "master" that generates clock and control communication start and end. The rest become "slave" which are controlled by an address peculiar to each device, like this EEPROM. The device that outputs data to the bus during data communication is called "transmitter", and the device that receives data is called "receiver".

### 2. START Condition (START bit Recognition)

- (1) Before executing each command, start condition (start bit) where SDA goes from 'HIGH' down to 'LOW' when SCL is 'HIGH' is necessary.
- (2) This IC always detects whether SDA and SCL are in start condition (start bit) or not, therefore, unless this condition is satisfied, any command cannot be executed.

### 3. STOP Condition (STOP bit Recognition)

- (1) Each command can be ended by a stop condition (stop bit) where SDA goes from 'LOW' to 'HIGH' while SCL is 'HIGH'. (See Figure 1-(b) START/STOP Bit Timing)

### 4. Write Protect By Soft Ware

- (1) Set Write Protect command and permanent set Write Protect command set data of 00h to 7Fh in 256 words write protection block. Clear Write Protect command can cancel write protection block which is set by set write Protect command. Cancel of write protection block which is set by permanent set Write Protect command at once is impossibility. When these commands are carried out, WP pin must be OPEN or GND.

### 5. Acknowledge

- (1) Acknowledge is a software used to indicate successful data transfers. The Transmitter device will release the BUS after transmitting eight bits. When inputting the slave address during write or read operation, the Transmitter is the  $\mu$ -COM. When outputting the data during read operation, the Transmitter is the EEPROM.
- (2) During the ninth clock cycle the Receiver will pull the SDA line Low to verify that the eight bits of data have been received. (When inputting the slave address during write or read operation, EEPROM is the receiver. When outputting the data during read operation the receiver is the  $\mu$ -COM.)
- (3) The device will respond with an Acknowledge after recognition of a START condition and its slave address (8bit).
- (4) In WRITE mode, the device will respond with an Acknowledge after the receipt of each subsequent 8-bit word (word address and write data).
- (5) In READ mode, the device will transmit eight bits of data, release the SDA line, and monitor the line for an Acknowledge.
- (6) If an Acknowledge is detected and no STOP condition is generated by the Master, the device will continue to transmit the data. If an Acknowledge is not detected, the device will terminate further data transmissions and await a STOP condition before returning to standby mode.

### 6. Device Addressing

Following a START condition, the Master outputs the Slave address to be accessed. The most significant four bits of the slave address are the "device type identifier." For this EEPROM it is "1010." (For WP register access this code is "0110".) The next three bits identify the specified device on the BUS (device address). The device address is defined by the state of the A0,A1 and A2 input pins. This IC works only when the device address input from the SDA pin corresponds to the status of the A0,A1 and A2 input pins. Using this address scheme allows up to eight devices to be connected to the BUS. The last bit of the stream ( $\overline{R/\overline{W}}$ ... $\overline{READ/\overline{WRITE}}$ ) determines the operation to be performed.

$\overline{R/\overline{W}}=0$	....	WRITE (including word address input of Random Read)
$\overline{R/\overline{W}}=1$	....	READ

Slave Address Set Pin			Device Type	Device Address			Read Write Mode	Access Area
A2	A1	A0	1010	A2	A1	A0	R / $\overline{W}$	2kbit Access to Memory
A2	A1	A0	0110	A2	A1	A0	R / $\overline{W}$	Access to Permanent Set Write Protect Memory
GND	GND	VHV		0	0	1	R / $\overline{W}$	Access to Set Write Protect Memroy
GND	VCC	VHV		0	1	1	R / $\overline{W}$	Access to Clear Write Protect Memory

### 7. Write Protect Pin (WP)

When WP pin set to Vcc (H level), write protect is set for 256 words (all address). When WP pin set to GND (L level), it is enable to write 256 words (all address).

If permanent protection is done by Write Protect command, lower half area (00 to 7Fh address) is inhibited writing regardless of WP pin state.

WP pin has a Pull-Down resistor. Please be left unconnected or connect to GND when WP feature is not in use.

### 8. Confirm Write Protect Resistor by ACK

According to state of Write Protect Resistor, ACK is as follows.

State of Write Protect Register	WP Input	Input Command	ACK	Address	ACK	Data	ACK	Write Cycle( $t_{WR}$ )
In case, protect by PSWP	-	PSWP, SWP, CWP	No ACK	-	No ACK	-	No ACK	No
		Page or Byte Write (00 to 7Fh)	ACK	WA7 to WA0	ACK	D7 to D0	No ACK	No
In case, protect by SWP	0	SWP	No ACK	-	No ACK	-	No ACK	No
		CWP	ACK	-	ACK	-	ACK	Yes
		PSWP	ACK	-	ACK	-	ACK	Yes
		Page or Byte Write (00 to 7Fh)	ACK	WA7 to WA0	ACK	D7 to D0	No ACK	No
	1	SWP	No ACK	-	No ACK	-	No ACK	No
		CSP	ACK	-	ACK	-	No ACK	No
		PSWP	ACK	-	ACK	-	No ACK	No
		Page or Byte Write	ACK	WA7 to WA0	ACK	D7 to D0	No ACK	No
In case, Not protect	0	PSWP, SWP, CWP	ACK	-	ACK	-	ACK	Yes
		Page or Byte Write	ACK	WA7 to WA0	ACK	D7 to D0	ACK	Yes
	1	PSWP, SWP, CWP	ACK	-	ACK	-	No ACK	No
		Page or Byte Write	ACK	WA7 to WA0	ACK	D7 to D0	No ACK	No

Acknowledge when writing data or defining the write-protection (instructions with  $R/\overline{W}$  bit=0) - is Don't Care

State of Write Protect Register	Command	ACK	Address	ACK	Data	ACK
In case, protect by PSWP	PSWP, SWP, CWP	No ACK	-	No ACK	-	No ACK
In case, protect by SWP	SWP	No ACK	-	No ACK	-	No ACK
	CWP	ACK	-	No ACK	-	No ACK
	PSWP	ACK	-	No ACK	-	No ACK
Case, Not protect	PSWP, SWP, CWP	ACK	-	No ACK	-	No ACK

Acknowledge when reading data the write-protection (instructions with  $R/\overline{W}$  bit=1)

## Command

### 1. Write Cycle

During WRITE CYCLE operation data is written in the EEPROM. The Byte Write Cycle is used to write only one byte. In the case of writing continuous data consisting of more than one byte, Page Write is used. The maximum bytes that can be written at one time is 16 bytes.

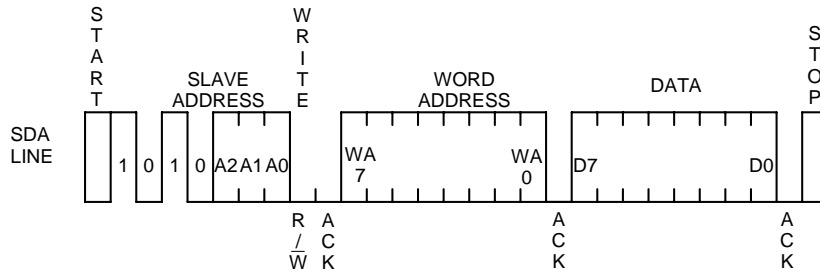

Figure 33. Byte Write Cycle Timing

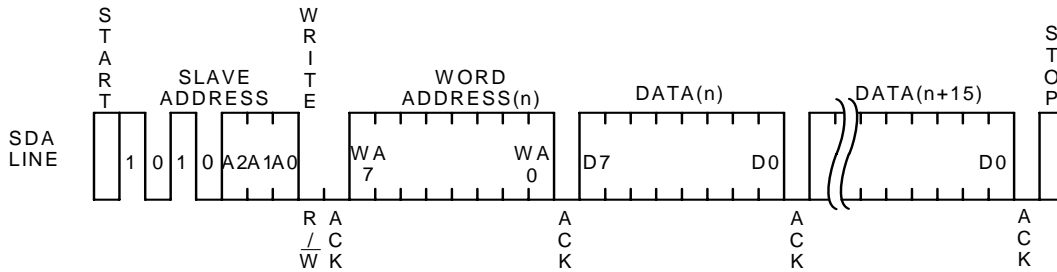

Figure 34. Page Write Cycle Timing

- (1) With this command the data is programmed into the indicated word address.
- (2) When the Master generates a STOP condition, the device begins the internal write cycle to the nonvolatile memory array.
- (3) Once programming is started no commands are accepted for  $t_{WR}$  (5ms max).
- (4) This device is capable of 16-byte Page Write operations.
- (5) If the Master transmits more than 16 words prior to generating the STOP condition, the address counter will "roll over" and the previously transmitted data will be overwritten. When two or more byte of data are input, the four low order address bits are internally incremented by one after the receipt of each word, while the four higher order bits of the address (WA7 to WA4) remain constant.

## 2. Read Cycle

During Read Cycle operation data is read from the EEPROM. The Read Cycle is composed of Random Read Cycle and Current Read Cycle. The Random Read Cycle reads the data in the indicated address.

The Current Read Cycle reads the data in the internally indicated address and verifies the data immediately after the Write Operation. The Sequential Read operation can be performed with both Current Read and Random Read. With the Sequential Read Cycle it is possible to continuously read the next data.

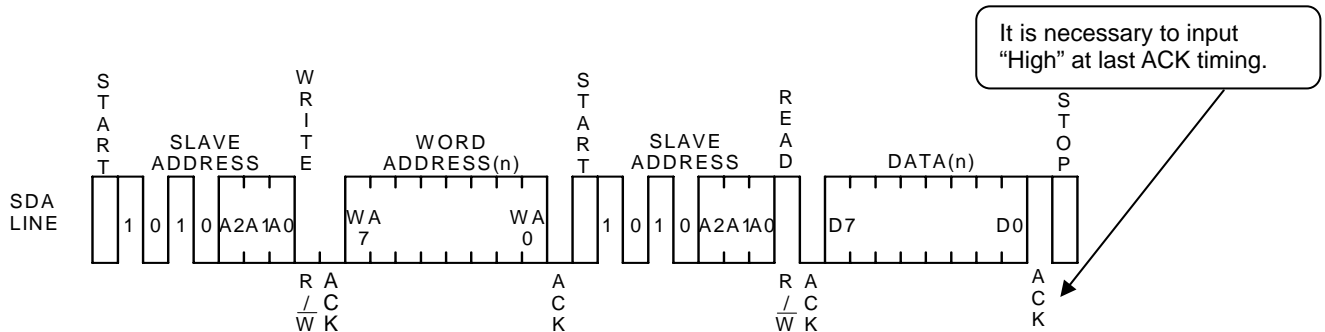

Figure 35. Random Read Cycle Timing

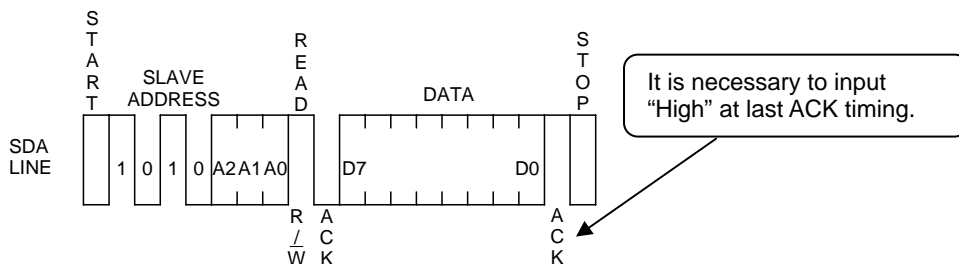

Figure 36. Current Read Cycle Timing

- (1) Random Read operation allows the Master to access any memory location indicated by word address.
- (2) In cases where the previous operation is Random or Current Read (which includes Sequential Read), the internal address counter is increased by one from the last accessed address (n). Thus Current Read outputs the data of the next word address (n+1).
- (3) If an Acknowledge is detected and no STOP condition is generated by the Master ( $\mu$ -COM), the device will continue to transmit data. (It can transmit all data (2kbit 256word))
- (4) If an Acknowledge is not detected, the device will terminate further data transmissions and await a STOP condition before returning to standby mode.
- (5) If an Acknowledge is detected with the "Low" level (not "High" level), the command will become Sequential Read, and the next data will be transmitted. Therefore, the Read command is not terminated. In order to terminate Read input Acknowledge with "High" always, then input a STOP condition.

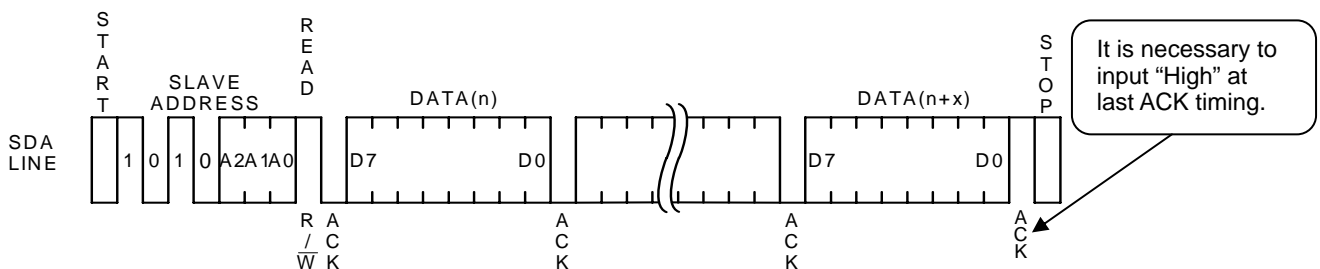

Figure 37. Sequential Read Cycle Timing (With Current Read)



### 3. Write Protect Cycle

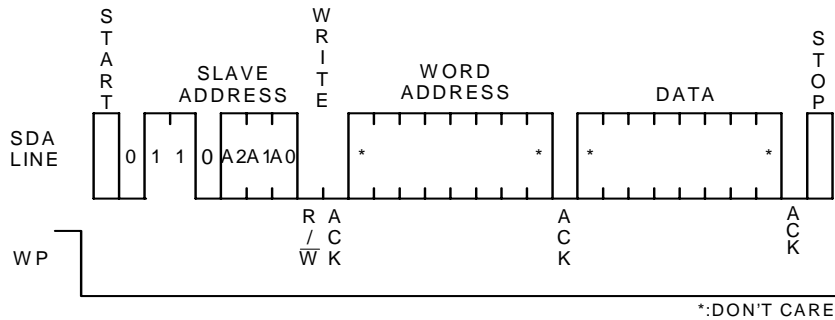

Figure 38. Permanent Set Write Protect Cycle

#### (1) Permanent Set Write Protect Cycle

- Permanent set Write Protect command set data of 00h to 7Fh in 256 words write protection block. Cancel of write protection block which is set by permanent set Write Protect command at once is impossibility. When these commands are carried out, WP pin must be OPEN or GND.
- Permanent Set Write Protect command needs  $t_{WR}$  from stop condition same as Byte Write and Page Write, during  $t_{WR}$ , input command is canceled.
- Refer to Page14 about reply of ACK in each protect state.

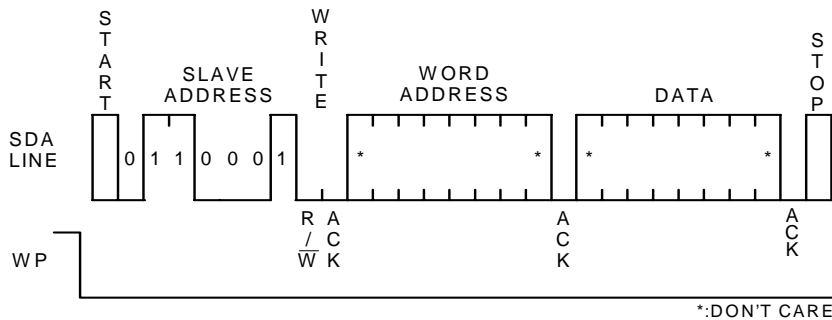

Figure 39. Set Write Protect Cycle

#### (2) Set Write Protect Cycle

- Set Write Protect command set data of 00h to 7Fh in 256 words write protection block. Clear Write Protect command can cancel write protection block which is set by set write Protect command. When these commands are carried out, WP pin must be OPEN or GND.
- Set write Protect command needs  $t_{WR}$  from stop condition same as Byte Write and Page Write, during  $t_{WR}$ , input command is canceled.
- Refer to Page14 about reply of ACK in each protect state.

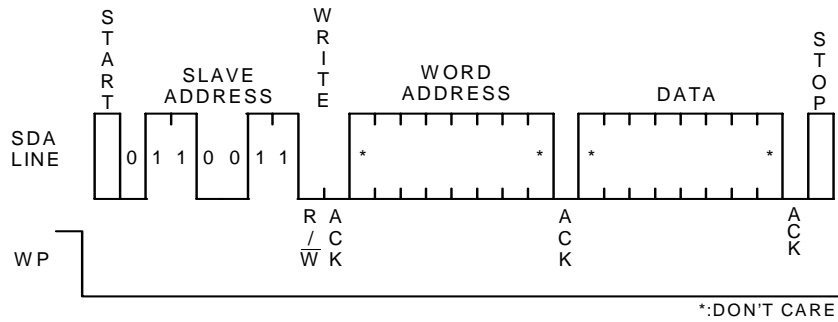

Figure 40. Clear Write Protect Cycle

**(3) Clear Write Protect Cycle**

- Clear Write Protect command can cancel write protection block which is set by set write Protect command. When these commands are carried out, WP pin must be OPEN or GND.
- Clear Write Protect command needs  $t_{WR}$  from stop condition same as Byte Write and Page Write, during  $t_{WR}$ , input command is canceled.
- Refer to Page14 about reply of ACK in each protect state.

**Software Reset**

Software reset is executed to avoid malfunction after power on and during command input. Software reset has several kinds and 3 kinds of them are shown in the figure below. (Refer to Figure 41-(a), Figure 41-(b), and Figure 41-(c).) Within the dummy clock input area, the SDA bus is released ('H' by pull up) and ACK output and read data '0' (both 'L' level) may be output from EEPROM. Therefore, if 'H' is input forcibly, output may conflict and over current may flow, leading to instantaneous power failure of system power source or influence upon devices.

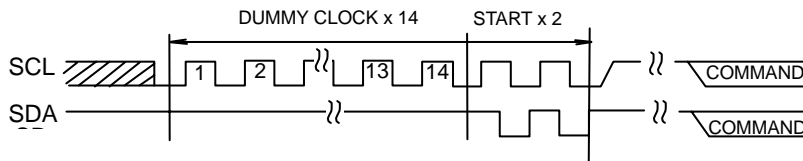

Figure 41-(a). DUMMY CLOCK x 14 + START + START

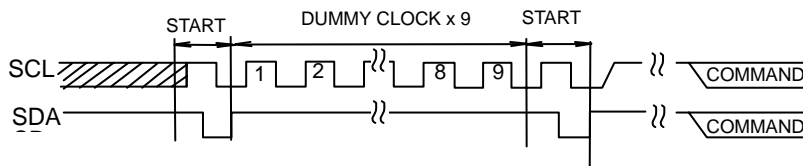

Figure 41-(b). START + DUMMY CLOCK x 9 + START

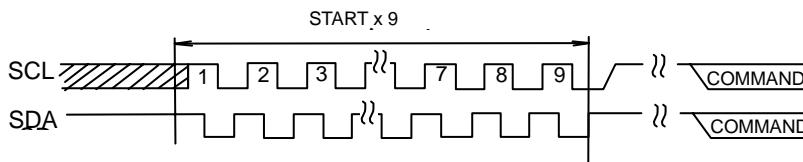

Figure 41-(c). START x 9

\* COMMAND starts with start condition.

**Acknowledge Polling**

During internal write execution, all input commands are ignored, therefore ACK is not returned. During internal automatic write execution after write cycle input, next command (slave address) is sent. If the first ACK signal sends back 'L', then it means end of write operation, else 'H' is returned, which means writing is still in progress. By the use of acknowledge polling, next command can be executed without waiting for  $t_{WR} = 5ms$ .

To write continuously,  $R/\overline{W} = 0$ , then to carry out current read cycle after write, slave address with  $R/\overline{W} = 1$  is sent. If ACK signal sends back 'L', and then execute word address input and data output and so forth.

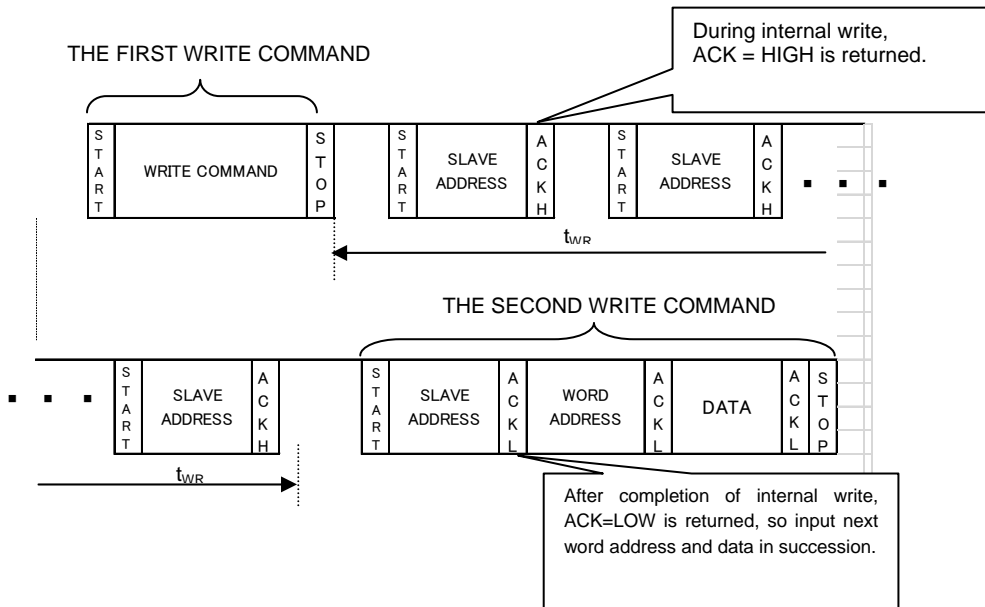

Figure 42. Case of Continuous Write by Acknowledge Polling

**WP Effective Timing**

WP is usually fixed to 'H' or 'L', but when WP is used to cancel write cycle and so on, observe the following WP valid timing. During write cycle execution, inside cancel valid area, by setting WP='H', write cycle can be cancelled. In both byte write cycle and page write cycle, the area from the first start condition of command to the rise of clock to take in D0 of data(in page write cycle, the first byte data) is the cancel invalid area.

WP input in this area becomes 'Don't care'. The area from the rise of SCL to take in D0 to the stop condition input is the cancel valid area. Furthermore, after the execution of forced end by WP, the IC enters standby status..

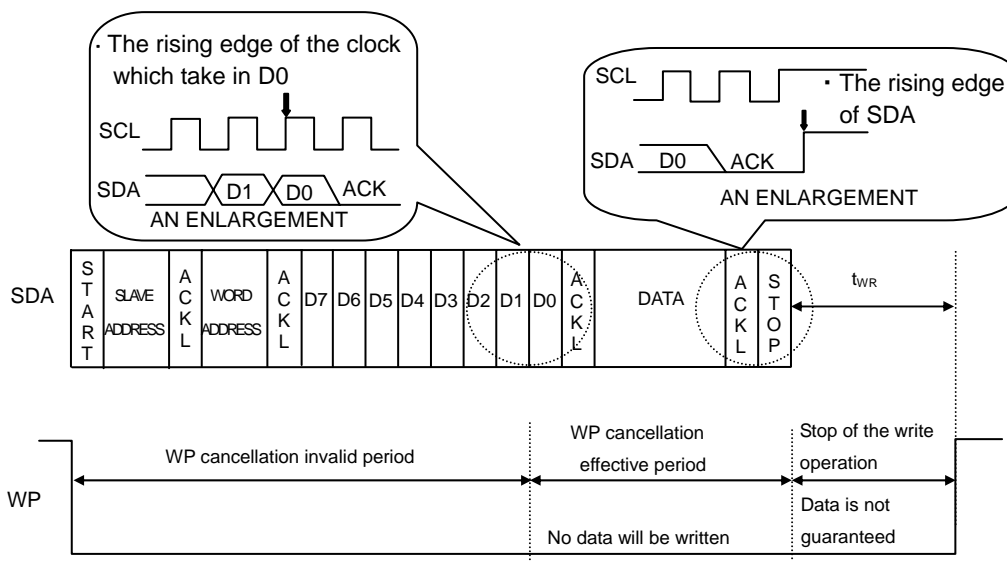

Figure 43. WP Effective Timing

## Command Cancellation from the START and STOP Conditions

During command input, by continuously inputting start condition and stop condition, command can be cancelled. (Figure 44.) However, within ACK output area and during data read, SDA bus may output 'L'. In this case, start condition and stop condition cannot be input, so reset is not available. Therefore, execute software reset. When command is cancelled by start-stop condition during random read cycle, sequential read cycle, or current read cycle, internal setting address is not determined. Therefore, it is not possible to carry out current read cycle in succession. To carry out read cycle in succession, carry out random read cycle.

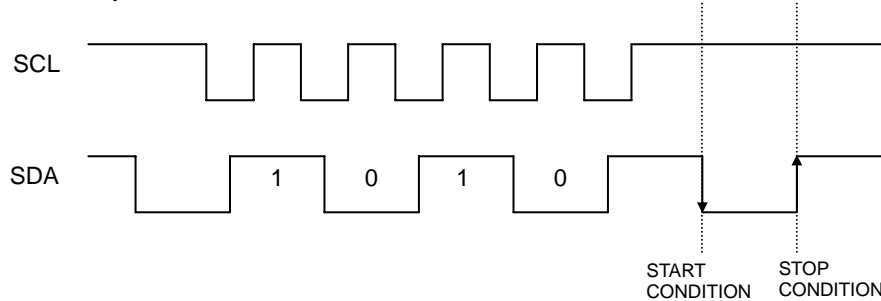

Figure 44. Command Cancellation by the START and STOP Conditions during Input of the Slave Address

## I/O Peripheral Circuit

### 1. Pull-Up Resistance of SDA Terminal

SDA is NMOS open drain, so it requires a pull up resistor. As for this resistance value ( $R_{PU}$ ), select an appropriate value from microcontroller  $V_{IL}$ ,  $I_L$ , and  $V_{OL-I_{OL}}$  characteristics of this IC. If  $R_{PU}$  is large, operating frequency is limited. The smaller the  $R_{PU}$ , the larger is the supply current (Read).

### 2. Maximum $R_{PU}$

The maximum value of  $R_{PU}$  is determined by the following factors.

- (1) SDA rise time to be determined by the capacitance ( $C_{BUS}$ ) of bus line and  $R_{PU}$  of SDA should be  $t_R$  or lower. Furthermore, AC timing should be satisfied even when SDA rise time is slow.
- (2) The bus. electric potential (A) to be determined by the input current leak total ( $I_L$ ) of device connected to bus at output of 'H' to the SDA line and  $R_{PU}$  should sufficiently secure the input 'H' level ( $V_{IH}$ ) of microcontroller and EEPROM including recommended noise margin of  $0.2V_{CC}$ .

$$V_{CC} - I_L R_{PU} - 0.2 V_{CC} \geq V_{IH}$$

$$\therefore R_{PU} \leq \frac{0.8V_{CC} - V_{IH}}{I_L}$$

Examples: When  $V_{CC} = 3V$ ,  $I_L = 10\mu A$ ,  $V_{IH} = 0.7 V_{CC}$   
According to (2)

$$R_{PU} \leq \frac{0.8 \times 3 - 0.7 \times 3}{10 \times 10^{-6}}$$

$$\leq 300 \text{ [k}\Omega\text{]}$$

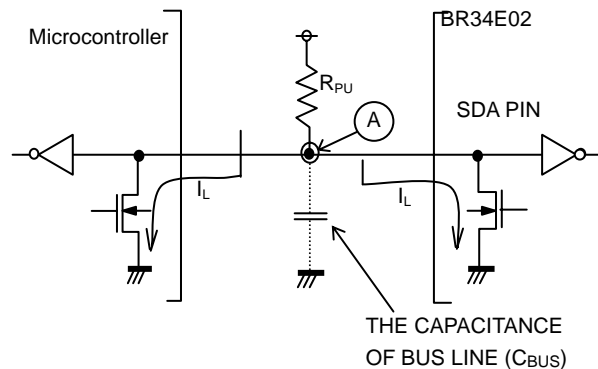

Figure 45. I/O Circuit

### 3. Minimum $R_{PU}$

The minimum value of  $R_{PU}$  is determined by following factors.

- (1) Meets the condition that  $V_{OLMAX}=0.4V$ ,  $I_{OLMAX}=3mA$  when the output is Low.

$$\frac{V_{CC}-V_{OL}}{R_{PU}} \leq I_{OL}$$

$$\therefore R_{PU} \geq \frac{V_{CC}-V_{OL}}{I_{OL}}$$

- (2)  $V_{OLMAX}=0.4V$  must be lower than the input Low level of the micro controller and the EEPROM including the recommended noise margin of  $0.1V_{CC}$ .

$$V_{OLMAX} \leq V_{IL}-0.1 V_{CC}$$

Examples:  $V_{CC}=3V$ ,  $V_{OL}=0.4V$ ,  $I_{OL}=3mA$ , the  $V_{IL}$  of the micro controller and the EEPROM is  $V_{IL}=0.3V_{CC}$ ,

According to (1)  $R_{PU} \geq \frac{3-0.4}{3 \times 10^{-3}}$

$$\geq 867 [\Omega]$$

And  $V_{OL}=0.4 [V]$

And  $V_{IL}=0.3 \times 3$   
 $=0.9 [V]$

so that condition (2) is met

### 4. Pull-up Resistance of SCL Terminal

When SCL control is made at the CMOS output port, there is no need for a pull up resistor. But when there is a time where SCL becomes 'Hi-Z', add a pull up resistor. As for the pull up resistor value, one of several k $\Omega$  to several ten k $\Omega$  is recommended in consideration of drive performance of output port of microcontroller.

## A0, A1, A2, WP Pin Connections

#### 1. Device Address Pin (A0, A1, A2) Connections

The status of the device address pins is compared with the device address sent by the Master. One of the devices that are connected to the identical BUS is selected. Pull up or down these pins or connect them to  $V_{CC}$  or GND. Pins that are not used as device address (N.C.Pins) may be High, Low, or Hi-Z.

#### 2. WP Pin Connection

The WP input allows or prohibits write operations. When WP is High, only Read is available and Write to all address is prohibited. Both Read and Write are available when WP is Low.

In the event that the device is used as a ROM, it is recommended that the WP input be pulled up or connected to  $V_{CC}$ . When both READ and WRITE are operated, the WP input must be pulled down or connected to GND or controlled.

## Microcontroller Connection

#### 1. $R_S$

In I<sup>2</sup>C BUS, it is recommended that SDA port is of open drain input/output. However, when using CMOS input / output of tri state to SDA port, insert a series resistance  $R_S$  between the pull up resistor  $R_{PU}$  and the SDA terminal of EEPROM. This is to control over current that may occur when PMOS of the microcontroller and NMOS of EEPROM are turned ON simultaneously.  $R_S$  also plays the role of protecting the SDA terminal against surge. Therefore, even when SDA port is open drain input/output,  $R_S$  can be used.

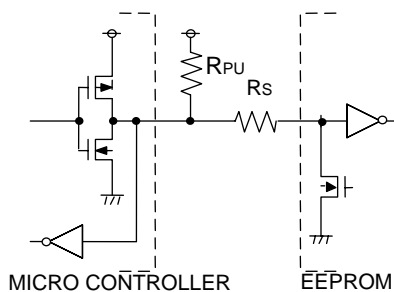

Figure 46. I/O Circuit

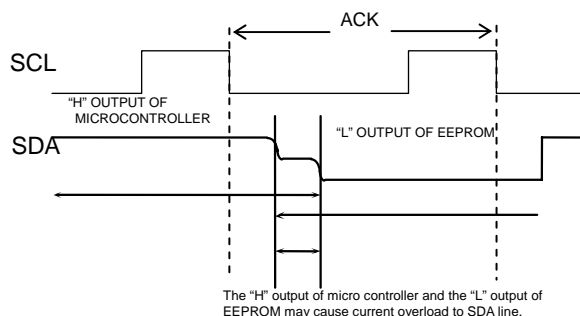

Figure 47. Input/Output Collision Timing

**2. Maximum Value of  $R_S$**

The maximum value of  $R_S$  is determined by the following relations.

- (1) SDA rise time to be determined by the capacitance ( $C_{BUS}$ ) of bus line and  $R_{PU}$  of SDA should be  $t_r$  or lower. Furthermore, AC timing should be satisfied even when SDA rise time is slow.
- (2) The bus' electric potential (A) to be determined by  $R_{PU}$  and  $R_S$  the moment when EEPROM outputs 'L' to SDA bus should sufficiently secure the input 'L' level ( $V_{IL}$ ) of microcontroller including recommended noise margin of  $0.1V_{CC}$ .

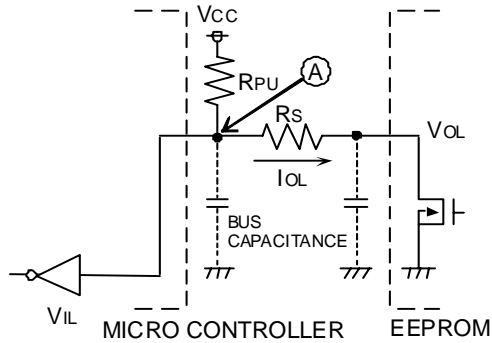

Figure 48. I/O Circuit

$$\frac{(V_{CC}-V_{OL}) \times R_S}{R_{PU}+R_S} + V_{OL} + 0.1V_{CC} \leq V_{IL}$$

$$\therefore R_S \leq \frac{V_{IL}-V_{OL}-0.1V_{CC}}{1.1V_{CC}-V_{IL}} \times R_{PU}$$

Examples: When  $V_{CC}=3V$ ,  $V_{IL}=0.3V_{CC}$ ,  $V_{OL}=0.4V$ ,  $R_{PU}=20k$

$$\text{According } R_S \leq \frac{0.3 \times 3 - 0.4 - 0.1 \times 3}{1.1 \times 3 - 0.3 \times 3} \times 20 \times 10^3$$

$$\leq 1.67[k\Omega]$$

**3. Minimum Value of  $R_S$**

The minimum value of  $R_S$  is determined by over current at bus collision. When over current flows, noises in power source line and instantaneous power failure of power source may occur. When allowable over current is defined as  $I$ , the following relation must be satisfied. Determine the allowable current in consideration of the impedance of power source line in set and so forth. Set the over current to EEPROM at  $10mA$  or lower.

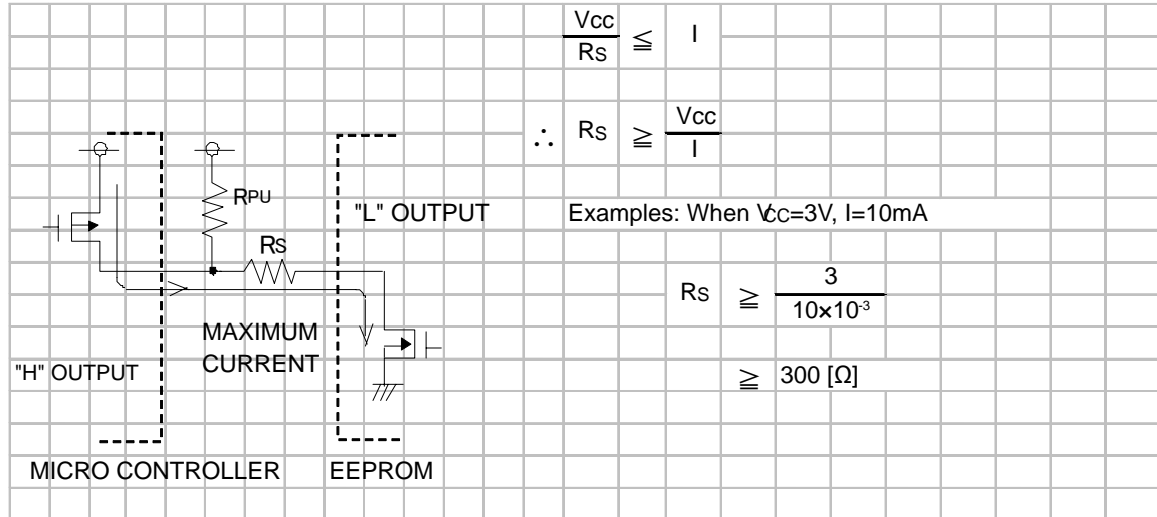

Figure 49. I/O Circuit

$$\frac{V_{CC}}{R_S} \leq I$$

$$\therefore R_S \geq \frac{V_{CC}}{I}$$

Examples: When  $V_{CC}=3V$ ,  $I=10mA$

$$R_S \geq \frac{3}{10 \times 10^{-3}}$$

$$\geq 300 [\Omega]$$

## I/O Equivalence Circuit

## 1. Input (A0,A1,A2,SCL)

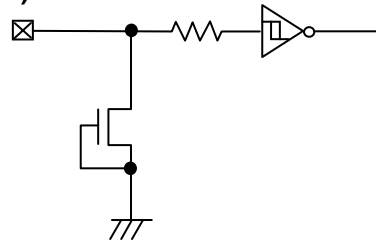

Figure 50. Input Pin Circuit Diagram

## 2. Input (SDA)

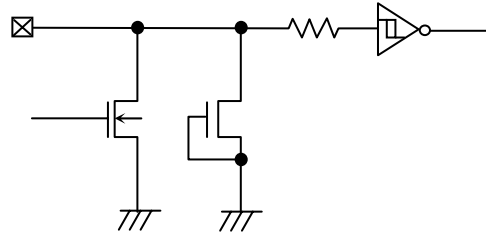

Figure 51. Input Pin Circuit Diagram

## 3. Input (WP)

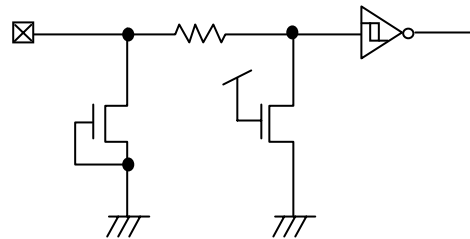

Figure 52. Input Pin Circuit Diagram

## Power-Up/Down Conditions

At power ON, the IC's internal circuits may go through unstable low voltage area as the  $V_{CC}$  rises, making the IC's internal logic circuit not completely reset, hence, malfunction may occur. To prevent this, the IC is equipped with POR circuit and LVCC circuit. To assure the operation, observe the following conditions at power ON.

1. "SDA='H'" and "SCL='L' or 'H'".
2. Follow the recommended conditions of  $t_R$ ,  $t_{OFF}$ ,  $V_{bot}$  so that P.O.R. will be activated during power up.

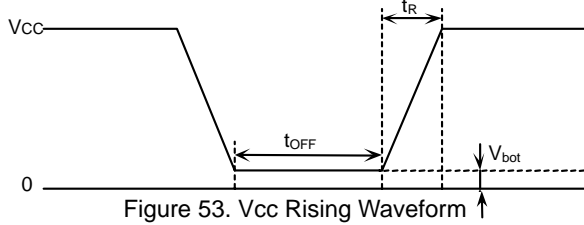

Figure 53. Vcc Rising Waveform

Recommended conditions of $t_R$ , $t_{OFF}$ , $V_{bot}$		
$t_R$	$t_{OFF}$	$V_{bot}$
Below 10ms	Above 10ms	Below 0.3V
Below 100ms	Above 10ms	Below 0.2V

3. Set SDA and SCL so as not to become "Hi-Z".  
When the above conditions 1 and 2 cannot be observed, take following countermeasures.

- (1) In the case when the above condition 1 cannot be observed such that SDA becomes 'L' at power ON.  
→Control SCL and SDA as shown below, to make SCL and SDA, 'H' and 'H'.

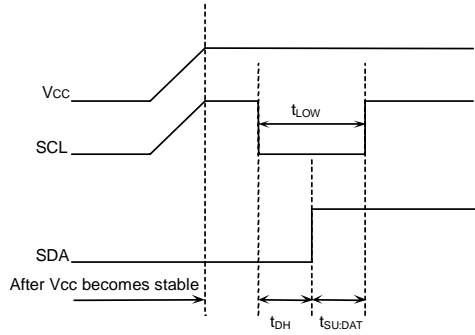

Figure 54. SCL="H" and SDA="L"

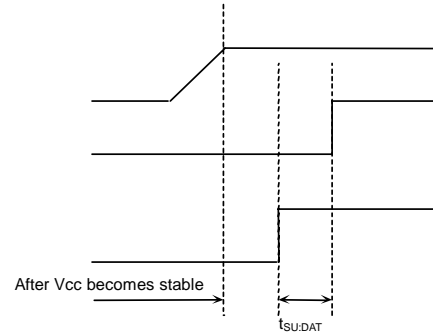

Figure 55. SCL="L" and SDA="L"

- (2) In the case when the above condition 2 cannot be observed.  
→After the power source become stable, execute software reset.(Figure 41)
- (3) In the case when the above condition 1 and 2 cannot be observed.  
→Carry out (1), and then carry out (2).

## Low Voltage Malfunction Prevention Function

LVCC circuit prevents data rewrite operation at low power, and prevents write error. At LVCC voltage (Typ =1.2V) or below, data rewrite is prevented.

## Noise Countermeasures

### 1. Bypass Capacitor

When noise or surge gets in the power source line, malfunction may occur, therefore, it is recommended to connect a bypass capacitor (0.1 $\mu$ F) between IC  $V_{CC}$  and GND pins. Connect the capacitor as close to IC as possible. In addition, it is also recommended to connect a bypass capacitor between board's  $V_{CC}$  and GND.



## Operational Notes

1. Described numeric values and data are design representative values only, and the values are not guaranteed.
2. We believe that the application circuit examples in this document are recommendable. However, in actual use, confirm characteristics further sufficiently. If changing the fixed number of external parts is desired, make your decision with sufficient margin in consideration of static characteristics, transient characteristics, and fluctuations of external parts and our LSI.
3. Absolute maximum ratings  
If the absolute maximum ratings such as supply voltage, operating temperature range, and so on are exceeded, LSI may be destroyed. Do not supply voltage or subject the IC to temperatures exceeding the absolute maximum ratings. In the case of fear of exceeding the absolute maximum ratings, take physical safety countermeasures such as adding fuses, and see to it that conditions exceeding the absolute maximum ratings should not be supplied to the LSI.
4. GND electric potential  
Set the voltage of GND terminal lowest at any operating condition. Make sure that each terminal voltage is not lower than that of GND terminal.
5. Thermal design  
Use a thermal design that allows for a sufficient margin by taking into account the permissible power dissipation (Pd) in actual operating conditions.
6. Short between Pins and Mounting Errors  
Be careful when mounting the IC on printed circuit boards. The IC may be damaged if it is mounted in a wrong orientation or if pins are shorted together. Short circuit may be caused by conductive particles caught between the pins.
7. Operating the IC in the presence of strong electromagnetic field may cause malfunction, therefore, evaluate design sufficiently.

## Part Numbering

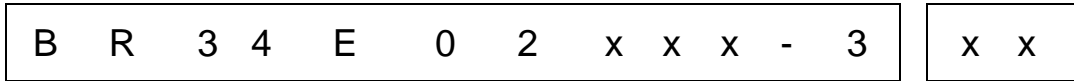
**BUS Type**34 : I<sup>2</sup>C**Operating Temperature**

-40°C to+85°C

**Capacity**

02=2K

**Package**

FVT :TSSOP-B8

NUX :VSON008X2030

**Process****Packaging and Forming Specification**E2 : Embossed tape and reel  
(TSSOP-B8)TR : Embossed tape and reel  
(VSON008X2030)

Physical Dimension Tape and Reel Information

TSSOP-B8

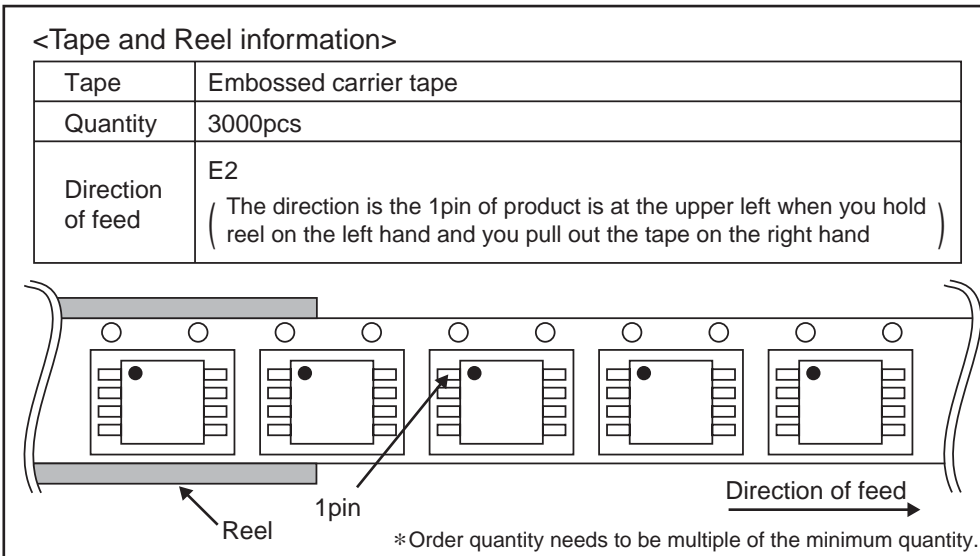
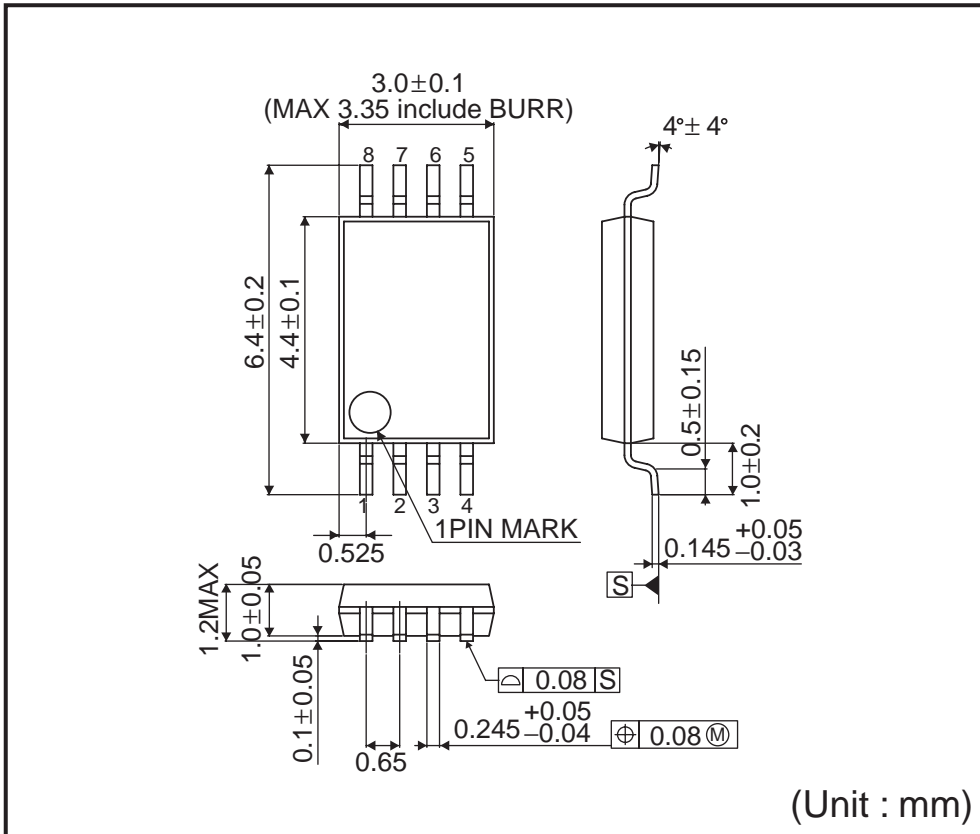



Marking Diagrams

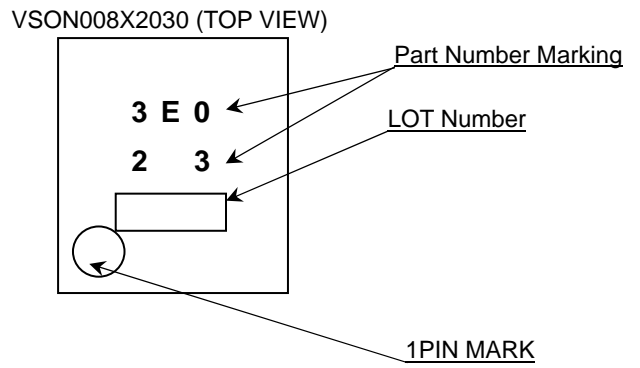
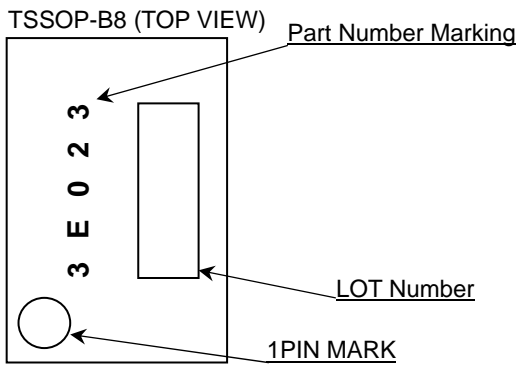

**Revision History**

Date	Revision	Changes
07.Sep.2012	001	New Release
25.Feb.2013	002	Update some English words, sentences' descriptions, grammar and formatting.
31.May.2013	003	P1 Change format of package line-up table. Add VESD in Absolute Maximum Ratings P.4 Add directions in Pin Descriptions

# Notice

## Precaution on using ROHM Products

- Our Products are designed and manufactured for application in ordinary electronic equipments (such as AV equipment, OA equipment, telecommunication equipment, home electronic appliances, amusement equipment, etc.). If you intend to use our Products in devices requiring extremely high reliability (such as medical equipment <sup>(Note 1)</sup>, transport equipment, traffic equipment, aircraft/spacecraft, nuclear power controllers, fuel controllers, car equipment including car accessories, safety devices, etc.) and whose malfunction or failure may cause loss of human life, bodily injury or serious damage to property ("Specific Applications"), please consult with the ROHM sales representative in advance. Unless otherwise agreed in writing by ROHM in advance, ROHM shall not be in any way responsible or liable for any damages, expenses or losses incurred by you or third parties arising from the use of any ROHM's Products for Specific Applications.

(Note1) Medical Equipment Classification of the Specific Applications

JAPAN	USA	EU	CHINA
CLASS III	CLASS III	CLASS II b	CLASS III
CLASS IV		CLASS III	

- ROHM designs and manufactures its Products subject to strict quality control system. However, semiconductor products can fail or malfunction at a certain rate. Please be sure to implement, at your own responsibilities, adequate safety measures including but not limited to fail-safe design against the physical injury, damage to any property, which a failure or malfunction of our Products may cause. The following are examples of safety measures:
  - Installation of protection circuits or other protective devices to improve system safety
  - Installation of redundant circuits to reduce the impact of single or multiple circuit failure
- Our Products are designed and manufactured for use under standard conditions and not under any special or extraordinary environments or conditions, as exemplified below. Accordingly, ROHM shall not be in any way responsible or liable for any damages, expenses or losses arising from the use of any ROHM's Products under any special or extraordinary environments or conditions. If you intend to use our Products under any special or extraordinary environments or conditions (as exemplified below), your independent verification and confirmation of product performance, reliability, etc. prior to use, must be necessary:
  - Use of our Products in any types of liquid, including water, oils, chemicals, and organic solvents
  - Use of our Products outdoors or in places where the Products are exposed to direct sunlight or dust
  - Use of our Products in places where the Products are exposed to sea wind or corrosive gases, including Cl<sub>2</sub>, H<sub>2</sub>S, NH<sub>3</sub>, SO<sub>2</sub>, and NO<sub>2</sub>
  - Use of our Products in places where the Products are exposed to static electricity or electromagnetic waves
  - Use of our Products in proximity to heat-producing components, plastic cords, or other flammable items
  - Sealing or coating our Products with resin or other coating materials
  - Use of our Products without cleaning residue of flux (even if you use no-clean type fluxes, cleaning residue of flux is recommended); or Washing our Products by using water or water-soluble cleaning agents for cleaning residue after soldering
  - Use of the Products in places subject to dew condensation
- The Products are not subject to radiation-proof design.
- Please verify and confirm characteristics of the final or mounted products in using the Products.
- In particular, if a transient load (a large amount of load applied in a short period of time, such as pulse. is applied, confirmation of performance characteristics after on-board mounting is strongly recommended. Avoid applying power exceeding normal rated power; exceeding the power rating under steady-state loading condition may negatively affect product performance and reliability.
- De-rate Power Dissipation (Pd) depending on Ambient temperature (Ta). When used in sealed area, confirm the actual ambient temperature.
- Confirm that operation temperature is within the specified range described in the product specification.
- ROHM shall not be in any way responsible or liable for failure induced under deviant condition from what is defined in this document.

## Precaution for Mounting / Circuit board design

- When a highly active halogenous (chlorine, bromine, etc.) flux is used, the residue of flux may negatively affect product performance and reliability.
- In principle, the reflow soldering method must be used; if flow soldering method is preferred, please consult with the ROHM representative in advance.

For details, please refer to ROHM Mounting specification

**Precautions Regarding Application Examples and External Circuits**

1. If change is made to the constant of an external circuit, please allow a sufficient margin considering variations of the characteristics of the Products and external components, including transient characteristics, as well as static characteristics.
2. You agree that application notes, reference designs, and associated data and information contained in this document are presented only as guidance for Products use. Therefore, in case you use such information, you are solely responsible for it and you must exercise your own independent verification and judgment in the use of such information contained in this document. ROHM shall not be in any way responsible or liable for any damages, expenses or losses incurred by you or third parties arising from the use of such information.

**Precaution for Electrostatic**

This Product is electrostatic sensitive product, which may be damaged due to electrostatic discharge. Please take proper caution in your manufacturing process and storage so that voltage exceeding the Products maximum rating will not be applied to Products. Please take special care under dry condition (e.g. Grounding of human body / equipment / solder iron, isolation from charged objects, setting of ionizer, friction prevention and temperature / humidity control).

**Precaution for Storage / Transportation**

1. Product performance and soldered connections may deteriorate if the Products are stored in the places where:
  - [a] the Products are exposed to sea winds or corrosive gases, including Cl<sub>2</sub>, H<sub>2</sub>S, NH<sub>3</sub>, SO<sub>2</sub>, and NO<sub>2</sub>
  - [b] the temperature or humidity exceeds those recommended by ROHM
  - [c] the Products are exposed to direct sunshine or condensation
  - [d] the Products are exposed to high Electrostatic
2. Even under ROHM recommended storage condition, solderability of products out of recommended storage time period may be degraded. It is strongly recommended to confirm solderability before using Products of which storage time is exceeding the recommended storage time period.
3. Store / transport cartons in the correct direction, which is indicated on a carton with a symbol. Otherwise bent leads may occur due to excessive stress applied when dropping of a carton.
4. Use Products within the specified time after opening a humidity barrier bag. Baking is required before using Products of which storage time is exceeding the recommended storage time period.

**Precaution for Product Label**

QR code printed on ROHM Products label is for ROHM's internal use only.

**Precaution for Disposition**

When disposing Products please dispose them properly using an authorized industry waste company.

**Precaution for Foreign Exchange and Foreign Trade act**

Since our Products might fall under controlled goods prescribed by the applicable foreign exchange and foreign trade act, please consult with ROHM representative in case of export.

**Precaution Regarding Intellectual Property Rights**

1. All information and data including but not limited to application example contained in this document is for reference only. ROHM does not warrant that foregoing information or data will not infringe any intellectual property rights or any other rights of any third party regarding such information or data. ROHM shall not be in any way responsible or liable for infringement of any intellectual property rights or other damages arising from use of such information or data.:
2. No license, expressly or implied, is granted hereby under any intellectual property rights or other rights of ROHM or any third parties with respect to the information contained in this document.

**Other Precaution**

1. This document may not be reprinted or reproduced, in whole or in part, without prior written consent of ROHM.
2. The Products may not be disassembled, converted, modified, reproduced or otherwise changed without prior written consent of ROHM.
3. In no event shall you use in any way whatsoever the Products and the related technical information contained in the Products or this document for any military purposes, including but not limited to, the development of mass-destruction weapons.
4. The proper names of companies or products described in this document are trademarks or registered trademarks of ROHM, its affiliated companies or third parties.



**General Precaution**

1. Before you use our Products, you are requested to carefully read this document and fully understand its contents. ROHM shall not be in any way responsible or liable for failure, malfunction or accident arising from the use of any ROHM's Products against warning, caution or note contained in this document.
2. All information contained in this document is current as of the issuing date and subject to change without any prior notice. Before purchasing or using ROHM's Products, please confirm the latest information with a ROHM sales representative.
3. The information contained in this document is provided on an "as is" basis and ROHM does not warrant that all information contained in this document is accurate and/or error-free. ROHM shall not be in any way responsible or liable for any damages, expenses or losses incurred by you or third parties resulting from inaccuracy or errors of or concerning such information.